

ENC

ISO Quality Management System Authentication



Users' Manual

EN500/600 series

Ver.4.0



SHENZHEN ENCOM ELECTRIC TECHNOLOGIES CO.,LTD.

Foreword

Thank you for purchasing EN500/EN600 series inverter developed and produced by Shenzhen Encom Electric Technologies CO., LTD.

EN500/EN600 series hi-performance flux vector inverter adopt advanced control mode to achieve high torque, high precision and wide-range speed regulation drive, and it also support speed sensorless torque control and PG control torque. It can meet customer all kinds of requirement to universal inverter. EN500/EN600 inverter is a organic combination for customer's universal and industrial control purpose and provide practical main-auxiliary frequency provision, run channel frequency binding, PID regulator, simple PLC, spinning traverse, programmable input&output terminal control, pulse frequency provision and inbuilt Modbus, Can bus, Profibus, 485 freedom protocol and other function and platform. It provide high integration solution for most manufacturing and automation customer and EN500/EN600 inbuilt input phase loss function, output phase loss function, short circuit to earth grounding function and many other protective function to improve effectively the system reliability and safety.

This brochure provide the installation and wiring, settings, fault check and methods, maintenance and other relative issues to customer. To make inverter assemble and operate rightly, and use its high performance to best, please read this brochure carefully before installation usage and keep them well to the final users of inverter.

Please contact our office or dealer anywhere at any moment when you have any doubts or special demands in using these inverters, and you can also contact our after service center in our Headquarters directly. We will serve you with all our heart.

We reserve our right to notice you if we change contents of this manual.

Content

| | | |
|-------|--|----|
| 1 | Safety information and use notice points | 1 |
| 1.1 | Safety precautions | 1 |
| 1.2 | Application range | 3 |
| 1.3 | Use notice points | 3 |
| 1.4 | Scraping handling notice | 4 |
| 2 | Inverter type and specification | 5 |
| 2.1 | Incoming inverter inspect | 5 |
| 2.2 | Type explanation | 5 |
| 2.3 | Nameplate explanation | 5 |
| 2.4 | Inverter type explanation | 6 |
| 2.5 | Appearance and parts name explanation | 7 |
| 2.6 | Outer size | 8 |
| 2.7 | EN500 optional base | 10 |
| 2.8 | Outer size of keypad and its fixing box | 12 |
| 2.9 | Product technic index and spec | 13 |
| 3 | Installation and wiring | 16 |
| 3.1 | Installation ambient | 16 |
| 3.1.1 | The demands for installation ambient | 16 |
| 3.1.2 | Installation direction and space | 16 |
| 3.2 | Parts disassembly and installation | 17 |
| 3.2.1 | Keyboard disassembly and installation | 17 |
| 3.2.2 | Cover disassembly and installation | 17 |
| 3.3 | Wiring notice points | 18 |
| 3.4 | Main loop terminal wiring | 19 |
| 3.4.1 | Connection between inverter and fitting parts | 21 |
| 3.4.2 | Main loop terminal wiring | 22 |
| 3.5 | Basic running wiring diagram | 25 |
| 3.6 | Control loop collocation and wiring | 25 |
| 3.6.1 | Relative location and function for control board terminal and slide switch | 25 |

| | | |
|-------|--|----|
| 3.6.2 | Descriptions for control board terminal | 27 |
| 3.6.3 | Analog input&output terminal wiring | 29 |
| 3.6.4 | Digital input terminal wiring | 30 |
| 3.6.5 | Communication terminal wiring | 32 |
| 4 | EMC (Electromagnetic compatibility) explanation | 34 |
| 4.1 | Noise interference restraining | 34 |
| 4.1.1 | Interference noise type | 34 |
| 4.1.2 | Basic countermeasure for restrain interference | 35 |
| 4.2 | Field wiring and earth grounding | 36 |
| 4.3 | Leak current and countermeasure | 36 |
| 4.4 | Installation demand for electromagnetic on-off electronic device | 37 |
| 4.5 | Noise filter installation instructions | 37 |
| 5 | Run and operation explanation for inverter | 38 |
| 5.1 | Run of inverter | 38 |
| 5.1.1 | Running order channels | 38 |
| 5.1.2 | Frequency-provision channel | 38 |
| 5.1.3 | Work state | 39 |
| 5.1.4 | Run mode | 40 |
| 5.2 | Operation and use of key board | 42 |
| 5.2.1 | Keypad layout | 42 |
| 5.2.2 | Keypad function description | 42 |
| 5.2.3 | LED and indicator light | 43 |
| 5.2.4 | Key board display status | 43 |
| 5.2.5 | User Management Parameters | 46 |
| 5.2.6 | Method for operating keypad | 46 |
| 5.3 | Inverter electrification | 49 |
| 5.3.1 | Check before electrification | 49 |
| 5.3.2 | First electrification | 49 |
| 6 | Function parameter schedule graph | 50 |
| 6.1 | Symbol description | 50 |
| 6.2 | Function parameter schedule graph | 50 |

| | | |
|---|---|-----|
| 7 | Detailed function specification | 93 |
| | 7.1 System Parameter Group: F00 | 93 |
| | 7.2 Basic Run Function Parameter Group:F01 | 102 |
| | 7.3 Start, stop, forward/reverse, brake function parameter group: F02..... | 111 |
| | 7.4 V/F control parameter group: F03 | 117 |
| | 7.5 Auxiliary running parameter group: F04 | 119 |
| | 7.6 Communication control parameter group: F05 | 125 |
| | 7.7 Setting curve parameter group: F06 | 130 |
| | 7.8 Analog quantity, Pulse input function parameter group: F07..... | 133 |
| | 7.9 On-off input function parameter group: F08 | 137 |
| | 7.10 Switch output function parameter group: F09 | 152 |
| | 7.11 Simple PLC/Multi-speed function parameters Group:F10 | 164 |
| | 7.12 Closed-Loop PID operation Parameters Group:F11..... | 170 |
| | 7.13 Constant pressure water supply function parameters Group: F12..... | 177 |
| | 7.14 Traverse, Fixed-length control Function Parameters Group: F13..... | 180 |
| | 7.15 Vector Control parameters Group: F14 | 184 |
| | 7.16 Motor parameters Group: F15 | 190 |
| | 7.17 Closed-loop encoder parameters Group: F16 | 192 |
| | 7.18 Reserved parameters Group1:F17..... | 195 |
| | 7.19 Enhanced Control Functions Parameters Group: F18 | 196 |
| | 7.20 Protective Relevant Function Parameters Group:F19 | 201 |
| | 7.21 Internal Virtual Input Output Node Parameter Group: F20 | 212 |
| | 7.22 Reserved parameter group 2:F21 | 214 |
| | 7.23 Reserved parameter group 3:F22 | 214 |
| | 7.24 Reserved parameter group 4:F23 | 214 |
| | 7.25 Reserved parameter group 5:F24 | 214 |
| | 7.26 User Definition Display Parameter Group: F25 | 215 |
| | 7.27 Fault Record Function Parameter Group: F26..... | 217 |
| | 7.28 Password and Manufacturer Function Parameter Group: F27 | 219 |
| 8 | Troubleshooting | 220 |



| | |
|---|-----|
| 8.1 Failure and countermeasure | 220 |
| 8.2 Failure record lookup | 225 |
| 8.3 Failure reset | 226 |
| 8.4 Alarm reset | 226 |
| 9 Maintenance | 227 |
| 9.1 Routine maintenance | 227 |
| 9.2 Inspection and replacement of damageable parts | 227 |
| 9.3 Repair guarantee | 228 |
| 9.4 Storage | 229 |
| Appendix A Modbus communication protocol | 230 |
| Appendix B Free-port communication protocol | 244 |
| Appendix C Keyboard | 256 |
| C.1 Keyboard selection | 256 |
| C.2 LED double-display digital potentiometer keyboard | 256 |
| C.3 LCD keyboard | 257 |
| C.4 LED single-display keyboard | 262 |
| C.5 Communication Component | 263 |
| Appendix D Communication extension card | 264 |
| D.1 Communication card selection | 264 |
| D.2 PROFIBUS-DP communication card | 264 |
| D.3 CANopen communication card | 267 |
| D.4 CANlink communication card | 269 |
| Appendix E Universal encoder expansion card | 271 |
| Appendix F Integration expansion card | 274 |
| Appendix G Braking unit and braking resistance | 276 |

1 Safety information and use notice points

To make ensure personal & equipment safety, this chapter must be read carefully before the inverter come into use.

1.1 Safety precautions

There are three kinds of safety warnings in this manual as below:

| Symbol | Symbol description |
|---|--|
|  | It may cause human death, serious injury or heavy property loss with wrong operation. |
|  | It may result body or device damage with wrong and timeless precautions under operation. |
|  Note | Should pay extra cautions when inverter in use under this symbol |



Forbid to cut off the power source directly when inverter under running, acceleration or deceleration status. Power source could cut off when inverter completely in halt and standby status. Otherwise user should be responsible for inverter and device damage and human injury.



- (1) Forbid to connect AC power source to output terminal U,V,W, otherwise it could cause inverter completely damage.
- (2) Not allow for short circuit between(-)and(+), otherwise it could cause inverter damage and power source short circuit.
- (3) Forbid to install inverter on flammable objects, otherwise it may cause fire.
- (4) Do not install inverter in a environment with explosive gas, it may cause explosion.
- (5) Bare connection terminal should be insulation treatment after main loop connection, otherwise it may cause electric shock.
- (6) Do not operate inverter with wet hands when inverter power on, otherwise it may cause electric shock.
- (7) Inverter earth terminal should be well grounding connection.
- (8) Do not open the front cover for wiring when inverter power on. Inverter wiring and check must handle after 10 minutes of inverter power off.
- (9) Wiring connection should handle by qualified person and not allow to slip any conductive objects inside inverter, otherwise it may cause a electric shock or inverter damage.
- (10) when inverter stocked for more than 6 months, using voltage regulator to boost voltage up and keep inverter in standby status for 1 hour, otherwise it may cause electric shock and explosion.



- (1) Forbid to connect control terminals except TA, TB, TC to AC 220V/380V signal, otherwise it may cause inverter completely damage.
- (2) Do not install and run inverter when inverter damage or spare part less, otherwise it may cause fire or human injury.
- (3) inverter should install in a place where can accept itself weight, otherwise it may cause inverter drop down or belongings damage.

1.2 Application range

- (1) This kind of inverter apply to 3 phase ac asynchronous motor only for general industry.
- (2) It should handle cautiously and consult with manufacturer when inverter apply to high reliability required equipment which relevant to life, properties and safety device.
- (3) This kind of inverter is the general motor control device in industry. When inverter apply to dangerous equipment, safeguard should be considerable in case of inverter failure.

1.3 Use notice points

- (1) EN500/EN600 series inverter belong to voltage type inverter, and it is normal with up temperature, noise and vibration of motor increasing over power frequency run slightly.
- (2) It is required to match inverter with variable frequency motor running at low speed with constant torque for long time. When match inverter with general asynchronous motor running at low speed, it should take measures to make motor heat dissipation or monitoring motor temperature in avoid of motor flash.
- (3) It is necessary to take measures in advance for the damage caused for the bad lubrication of the reduction box and wheel gear mechanical devices running at low speed for long time.
- (4) It is necessary to assure at first that the use speed range of motor bearings and mechanical devices, also the increasing of motor vibration and noise should be considered, when motor run over rated frequency.
- (5) It is necessary to select the suitable brake assembly for hoisting device and big inertia load to make sure the normal work when inverter stripping from power grid for the overcurrent or overvoltage failure.
- (6) Inverter start and stop control through terminal or other normal command channel, otherwise it may cause inverter damage via connecting inverter input terminal to big current switch just like contactor direct to start and stop inverter frequently.
- (7) It is necessary to make sure inverter cut off from operation without output, when inverter and motor connect through switch components just like contactor etc. Otherwise it will cause inverter damage.
- (8) When inverter output frequency within some range, it may meet mechanical resonance point of load device, through setting jump frequency to avoid it.
- (9) Checking power supply voltage within allowed working range before usage, otherwise, it need to change voltage or custom special voltage inverter.

(10)When inverter usage site altitude over1000 meters, inverter should derate current to use, output current decrease about 10% of rated current per 1000 meters increase.

(11)Motor should do insulation check before first usage or reuse after lay aside for long time. Checking method show as graph 1-1 below with 500V voltage type megohm meter , insulation resistance should not smaller than 5 MΩ, otherwise inverter maybe damaged.

(12)Forbid inverter output side to assemble capacitor to improve power factor or anti-thunder dependent resistor etc, otherwise it may cause inverter fault trip or component damage show as graph 1-2.

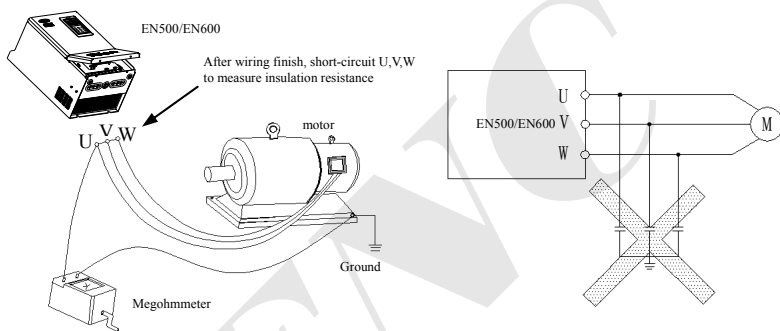

Fig.1-1 motor insulation check Fig.1-2 capacitor at output side forbidden

1.4 Scraping handling notice:

Notices when handling with scrapped inverter and components:

- (1) The unit: dispose the inverter as industrial waste.
- (2) Electrolytic capacitor: It may cause explosion when electrolytic capacitor under burning.
- (3)Plastic: it may result in harmful and poisonous gas when plastic and rubber of inverter burning, and safeguard preparations should be taken before burning.

2 Inverter type and specification

2.1 Incoming inverter inspect

- (1) Check if there is damage during transportation and inverter itself has damage or fall-off parts.
- (2) Check if parts presented in packing list are all ready.
- (3) Please confirm nameplate data of the inverter is in line with your order requirement.

Our product is guaranteed by strict quality system during manufacturing, packing, transportation etc., please contact our company or local agent rapidly if some careless omission or mistake arise, we'll deal with it as soon as possible.

2.2 Type explanation

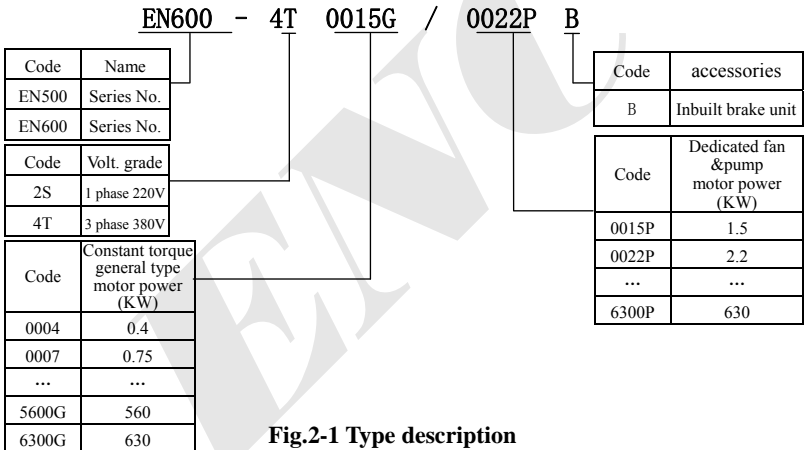

Fig.2-1 Type description

2.3 Nameplate explanation

Nameplate presented as figure 2-2 with type and rating data at the bottom of inverter right side.

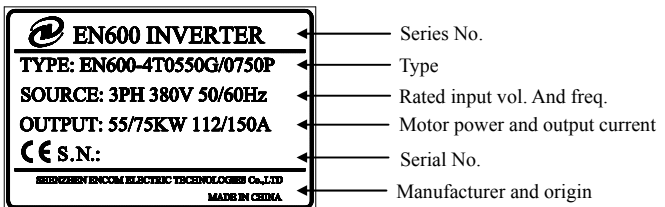

Fig.2-2 Nameplate

2.4 Inverter type explanation

| Input Voltage | Inverter type | Rated output Current(A) | Adaptable motor (KW) |
|---------------------|---------------------|-------------------------|----------------------|
| 1 phase 220V | EN600-2S0004 | 2.5 | 0.4 |
| | EN600-2S0007 | 4 | 0.75 |
| | EN600-2S0015 | 7 | 1.5 |
| | EN600-2S0022 | 10 | 2.2 |
| | EN600-2S0037 | 15 | 3.7 |
| 3 phase 380V | EN600-4T0007G/0015P | 2.3/3.7 | 0.75/1.5 |
| | EN600-4T0015G/0022P | 3.7/5 | 1.5/2.2 |
| | EN600-4T0022G/0037P | 5/8.5 | 2.2/3.7 |
| | EN600-4T0037G/0055P | 8.5/13 | 3.7/5.5 |
| | EN600-4T0055G/0075P | 13/17 | 5.5/7.5 |
| | EN600-4T0075G/0110P | 17/25 | 7.5/11 |
| | EN600-4T0110G/0150P | 25/33 | 11/15 |
| | EN600-4T0150G/0185P | 33/39 | 15/18.5 |
| | EN600-4T0185G/0220P | 39/45 | 18.5/22 |
| | EN600-4T0220G/0300P | 45/60 | 22/30 |
| | EN600-4T0300G/0370P | 60/75 | 30/37 |
| | EN600-4T0370G/0450P | 75/91 | 37/45 |
| | EN600-4T0450G/0550P | 91/112 | 45/55 |
| | EN600-4T0550G/0750P | 112/150 | 55/75 |
| | EN500-4T0750G/0900P | 150/176 | 75/90 |
| | EN500-4T0900G/1100P | 176/210 | 90/110 |
| | EN500-4T1100G/1320P | 210/253 | 110/132 |
| | EN500-4T1320G/1600P | 253/304 | 132/160 |
| | EN500-4T1600G/2000P | 304/380 | 160/200 |
| | EN500-4T2000G/2200P | 380/426 | 200/220 |
| | EN500-4T2200G/2500P | 426/474 | 220/250 |
| | EN500-4T2500G/2800P | 474/520 | 250/280 |
| | EN500-4T2800G/3150P | 520/600 | 280/315 |
| | EN500-4T3150G/3550P | 600/650 | 315/355 |
| | EN500-4T3550G/3750P | 650/680 | 355/375 |
| | EN500-4T3750G/4000P | 680/750 | 375/400 |
| EN500-4T4000G/4500P | 750/800 | 400/450 | |
| EN500-4T4500G/5000P | 800/870 | 450/500 | |

| | | |
|---------------------|----------|---------|
| EN500-4T5000G/5600P | 870/940 | 500/560 |
| EN500-4T5600G/6300P | 940/1100 | 560/630 |
| EN500-4T6300G | 1100 | 630 |

2.5 Appearance and parts name explanation

2.5.1 EN600 Appearance and parts name explanation

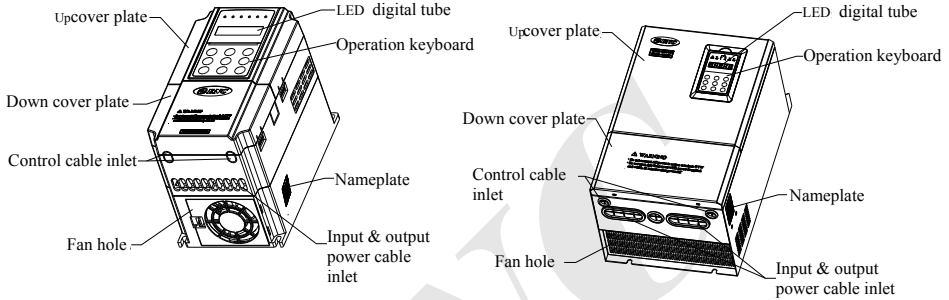

Fig.2-3 EN600 Parts name sketch

2.5.2 EN500 Appearance and parts name explanation

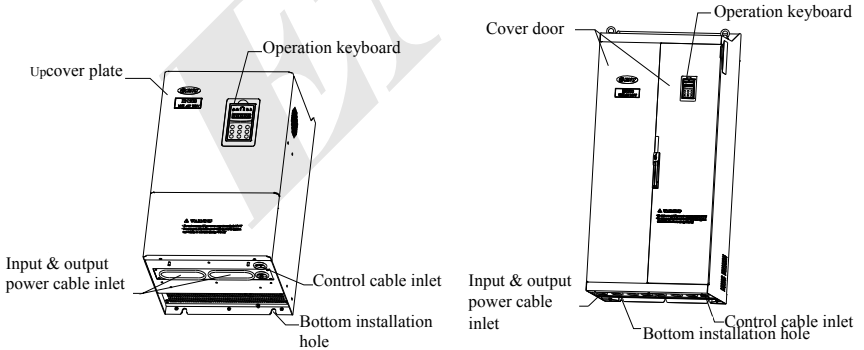

Fig.2-4 EN500 Parts name sketch

2.6 Outer size

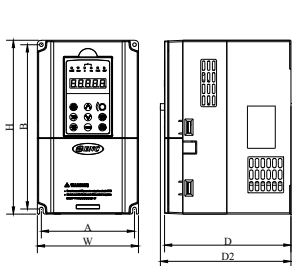

Fig.a

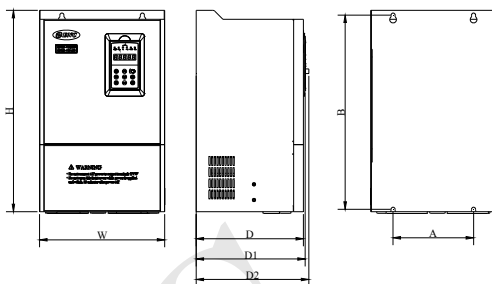

Fig.b

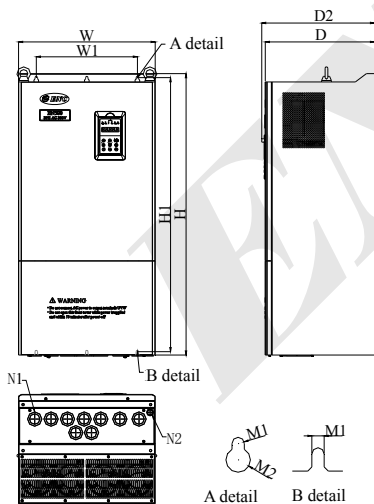

Fig.c

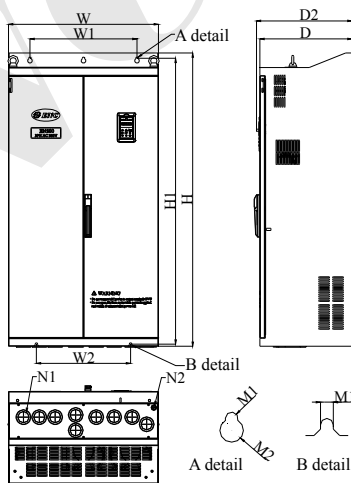

Fig.d

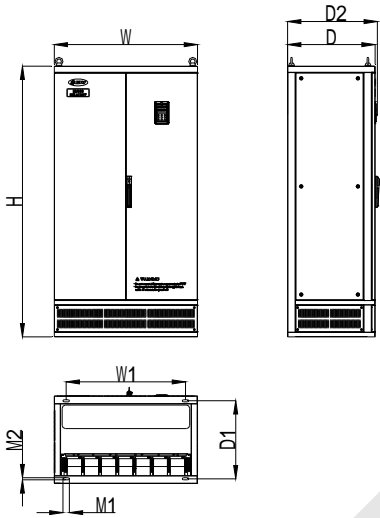

Fig.e

Fig.2-5 Outer dimension

Table 2-1 EN600 mounting size

| Inverter type | A (mm) | B (mm) | W (mm) | H (mm) | D (mm) | D1 (mm) | D2 (mm) | Fix Hole (mm) | Fig. No. |
|---------------------|--------|--------|--------|--------|--------|---------|---------|---------------|----------|
| EN600-2S0004 | 104 | 186 | 115 | 200 | 151 | - | 164 | 5 | Fig.a |
| EN600-2S0007 | | | | | | | | | |
| EN600-2S0015 | | | | | | | | | |
| EN600-2S0022 | | | | | | | | | |
| EN600-2S0037 | 129 | 227 | 140 | 240 | 175 | - | 188 | 5 | Fig.a |
| EN600-4T0007G/0015P | 104 | 186 | 115 | 200 | 151 | - | 164 | 5 | Fig.a |
| EN600-4T0015G/0022P | | | | | | | | | |
| EN600-4T0022G/0037P | | | | | | | | | |
| EN600-4T0037G/0055P | | | | | | | | | |
| EN600-4T0055G/0075P | 129 | 227 | 140 | 240 | 175 | - | 188 | 5 | Fig.a |
| EN600-4T0075G/0110P | 165 | 281 | 180 | 304 | 189 | - | 202 | 6 | Fig.a |
| EN600-4T0110G/0150P | | | | | | | | | |
| EN600-4T0150G/0185P | | | | | | | | | |
| EN600-4T0185G/0220P | 180 | 382 | 250 | 398 | 210 | 214 | 223 | 9 | Fig.b |
| EN600-4T0220G/0300P | | | | | | | | | |
| EN600-4T0300G/0370P | 180 | 434 | 280 | 450 | 240 | 244 | 253 | 9 | Fig.b |
| EN600-4T0370G/0450P | | | | | | | | | |
| EN600-4T0450G/0550P | 190 | 504.5 | 290 | 530 | 250 | 254 | 263 | 9 | Fig.b |
| EN600-4T0550G/0750P | | | | | | | | | |

Table 2-2 EN500 mounting size

| Inverter type | H (mm) | H1 (mm) | W (mm) | W1 (mm) | W2 (mm) | D (mm) | D1 (mm) | D2 (mm) | N1 (mm) | N2 (mm) | M1 (mm) | M2 (mm) | Fig. No. | |
|---------------------|-----------|------------|-----------|------------|------------|-----------|------------|------------|-------------|------------|------------|------------|----------|-------|
| EN500-4T0750G/0900P | 570 | 546 | 340 | 237 | - | 320 | - | 333 | - | - | Φ12 | Φ18 | Fig.c | |
| EN500-4T0900G/1100P | | | | | | | | | | | | | | |
| EN500-4T1100G/1320P | 650 | 628 | 400 | 297 | - | 340 | - | 353 | - | - | Φ12 | Φ18 | | Fig.c |
| EN500-4T1320G/1600P | 650 | 628 | 420 | 297 | - | 340 | - | 353 | - | - | Φ12 | Φ18 | | |
| EN500-4T1600G/2000P | 980 | 953 | 480 | 370 | - | 400 | - | 413 | Φ38 | Φ19 | Φ9 | Φ18 | | |
| EN500-4T2000G/2200P | 1030 | 1003 | 500 | 370 | - | 400 | - | 413 | Φ38 | Φ19 | Φ9 | Φ18 | Fig.d | |
| EN500-4T2200G/2500P | | | | | | | | | | | | | | |
| EN500-4T2500G/2800P | 1368 | 1322 | 700 | 500 | 440 | 430 | - | 443 | Φ52 | Φ19 | Φ12 | Φ22 | | Fig.d |
| EN500-4T2800G/3150P | | | | | | | | | | | | | | |
| EN500-4T3150G/3550P | | | | | | | | | | | | | | |
| EN500-4T3550G/3750P | 1518 | 1483 | 700 | 500 | 500 | 430 | - | 443 | OB 77*47 | Φ19 | Φ12 | Φ22 | | |
| EN500-4T3750G/4000P | | | | | | | | | | | | | | |
| EN500-4T4000G/4500P | | | | | | | | | | | | | | |
| EN500-4T4500G/5000P | 1650 | - | 850 | 700 | - | 550 | 490 | 563 | - | - | 40 | Φ13 | Fig.e | |
| EN500-4T5000G/5600P | | | | | | | | | | | | | | |
| EN500-4T5600G/6300P | 1700 | - | 900 | 750 | - | 550 | 490 | 563 | - | - | 40 | Φ13 | | |
| EN500-4T6300G | | | | | | | | | | | | | | |

2.7 EN500 optional base

2.7.1 EN500 inverter and base selection table

| Type | Base model | | | |
|---------------------|---------------|-------------------------|--------------------------|----------------------|
| | Standard base | base with Input reactor | Base with output reactor | base with DC reactor |
| EN500-4T0750G/0900P | SP-BS-0900 | SP-BS-0750-LI | SP-BS-0900-LO | SP-BS-0750-LD |
| EN500-4T0900G/1100P | | SP-BS-0900-LI | SP-BS-0900-LO | - |
| EN500-4T1100G/1320P | SP-BS-1100 | SP-BS-1100-LI | SP-BS-1100-LO | - |
| EN500-4T1320G/1600P | SP-BS-1320 | SP-BS-1320-LI | SP-BS-1320-LO | - |
| EN500-4T1600G/2000P | SP-BS-1600 | SP-BS-1600-LI | SP-BS-1600-LO | - |
| EN500-4T2000G/2200P | SP-BS-2200 | SP-BS-2000-LI | SP-BS-2000-LO | - |
| EN500-4T2200G/2500P | | SP-BS-2200-LI | SP-BS-2200-LO | - |
| EN500-4T2500G/2800P | SP-BS-4000 | SP-BS-2500-LI | SP-BS-2500-LO | - |
| EN500-4T2800G/3150P | | SP-BS-2800-LI | SP-BS-2800-LO | - |
| EN500-4T3150G/3550P | | SP-BS-3150-LI | SP-BS-3150-LO | - |
| EN500-4T3550G/3750P | | SP-BS-4000-LI | SP-BS-4000-LO | - |
| EN500-4T3750G/4000P | | SP-BS-4000-LI | SP-BS-4000-LO | - |
| EN500-4T4000G/4500P | | SP-BS-4000-LI | SP-BS-4000-LO | - |

2.7.2 Base outer dimension

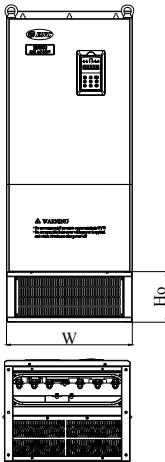

Fig.a

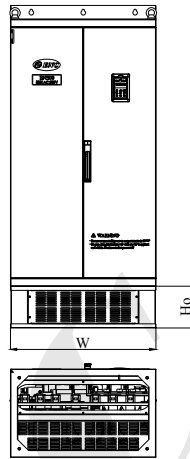
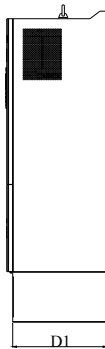

Fig.b

Fig.2-6 base dimension

Table 2-3 base size

| Base model | W (mm) | D1 (mm) | Ho (mm) | Fig. |
|---------------|-----------|------------|------------|-------|
| SP-BS-0900 | 340 | 300 | 180 | Fig.a |
| SP-BS-0750-LI | 340 | 300 | 350 | |
| SP-BS-0750-LD | | | | |
| SP-BS-0900-LI | | | | |
| SP-BS-0900-LO | | | | |
| SP-BS-1100 | 400 | 320 | 180 | |
| SP-BS-1100-LI | 400 | 320 | 380 | |
| SP-BS-1100-LO | | | | |
| SP-BS-1320 | 420 | 320 | 180 | |
| SP-BS-1320-LI | 420 | 320 | 380 | |
| SP-BS-1320-LO | | | | |
| SP-BS-1600 | 480 | 380 | 180 | |
| SP-BS-1600-LI | 480 | 380 | 400 | |
| SP-BS-1600-LO | | | | |
| SP-BS-2200 | 500 | 380 | 200 | |

| | | | | |
|---------------|-----|-----|-----|-------|
| SP-BS-2000-LI | 500 | 380 | 400 | Fig.b |
| SP-BS-2000-LO | | | | |
| SP-BS-2200-LI | | | | |
| SP-BS-2200-LO | | | | |
| SP-BS-4000 | 700 | 430 | 204 | |
| SP-BS-2500-LI | 700 | 430 | 400 | |
| SP-BS-2500-LO | | | | |
| SP-BS-2800-LI | | | | |
| SP-BS-2800-LO | | | | |
| SP-BS-3150-LI | | | | |
| SP-BS-3150-LO | | | | |
| SP-BS-4000-LI | 700 | 430 | 450 | |
| SP-BS-4000-LO | | | | |

2.8 Outer size of keypad and its fixing box(unit:mm)

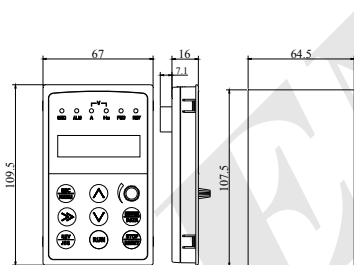

Fig.2-7 Mounting size of keypad

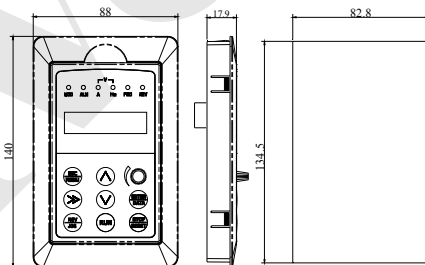

Fig.2-8 Hole size of keypad



Note

1. EN-LCD2 long-distance keypad outer lead, do not support keypad holder installed, only keypad installed support, mounting size refer to Fig.2-7.
2. Except EN-LCD2 long-distance keypad, when other keypad outer lead, user can adjust the hole size under actual situation on keypad or keypad holder; thickness of install board between 1.0~1.5mm is suggested.
3. When installed with keypad holder, it need to buy extra.

2.9 Product technic index and spec

| Item | | Item description | |
|---------------------|---|---|------------------------|
| Input | Rating volt., frequency | 1 phase 220V Grade: 1 phase 220V, 50Hz/60Hz 3 phase 380V Grade: 3 phase 380V, 50Hz/60Hz | |
| | Allowed volt. range | 1 phase 220V Grade: 200~260V 3 phase 380V Grade: 320~460V | |
| Output | Voltage | 0~380V | |
| | Frequency | 0~600Hz | |
| | Over loading capacity | G type: 150% of rated current for 1 minute; P type: 120% of rated current for 1 minute. | |
| Control Performance | Control mode | vector control, PG vector control, open-loop V/F control, torque control, PG torque control | |
| | Velocity control precision | ±0.5% rated synchronous speed (vector control); ±0.1% rated synchronous speed (PG vector control); ±1% rated synchronous speed (V/F control); | |
| | Speed regulation range | 1: 2000 (PG vector control) 1: 100 (vector control); 1: 50 (V/F control); | |
| | Start-up torque | 1.0Hz: 150% rated torque (V/F control); 0.5Hz: 150% rated torque (vector control); 0Hz: 180% rated torque (PG vector control); | |
| | Speed fluctuation | ±0.3% rated synchronous speed (vector control); ±0.1% rated synchronous speed (PG vector control); | |
| | Torque control precision | ±10% rated torque (vector control, torque control); ±5% rated torque (PG vector control, PG torque control) | |
| | Torque response | ≤20ms (vector control); ≤10ms (PG vector control); | |
| | Frequency precision | Digital setting: max. frequency×±0.01%; Analog setting: max. frequency×±0.5% | |
| | Freq. resolution | Analog setting | 0.1% of max. frequency |
| | | Digital setting precision | 0.01Hz |
| | | Exterior impulse | 0.1% of max. frequency |
| | Torque boost | Automatic torque boost; manual torque boost 0.1~12.0% | |
| | V/F curve(volt. Frequency characteristic) | Setting rated frequency at the range of 5~650Hz, by choosing constant torque, degressive torque 1, degressive torque 2, degressive torque 3, self-defined V/F total 5 kinds of curve. | |
| | Acceleration Deceleration curve | Two modes: straight line acceleration and deceleration; S curve acceleration and deceleration; 15 kinds of acceleration and deceleration time, time unit (0.01s, 0.1s, 1s) for option , max. time for 1000 minutes. | |

2 Inverter type and specification

| | | | |
|-----------------------------|-------------------------------------|--|--|
| | brake | Power consumption brake | EN600 3 phase 15KW & under power range with inbuilt brake unit. only add brake resistor between (+) and PB. 18.5KW & up power range is possible to add brake unit between (+) and (-) outside; or extra connect brake unit with adding brake resistor between (+) and PB. EN500 series can connect brake unit between (+) and (-) outside. |
| | | DC brake | Start, stop action for option, action frequency 0~15Hz, action current 0~100% of rated current, action time 0~30.0s |
| | jog | Jog frequency range: 0Hz~up limit frequency; jog acceleration and deceleration time 0.1~6000.0 seconds for setting. | |
| | Multi-section speed run | Realized by inbuilt PLC or control terminal; with 15 section speed, each section speed with separately acceleration and deceleration time; with inbuilt PLC can achieve reserve when power down. | |
| | Inbuilt PID controller | Convenient to make closed-loop control system | |
| | Automatic energy saving run | Optimize V/F curve automatically to achieve power saving run according to the load status. | |
| | Automatic voltage regulate(AVR) | Automatically keep output voltage constant, when the power grid voltage fluctuation | |
| | Automatic current limiting | Current limited automatically under run mode in avoid of inverter over-current frequently to trip. | |
| | carrier modulation | Modulate carrier wave automatically according to the load characteristic. | |
| | Speed tracking restart | Make rotating motor smoothly start without shocking | |
| Running function | running command specified channel | Keypad specified, control terminal specified, communication specified can switch through various means. | |
| | Running frequency specified channel | Main & auxiliary specified to a realize one main adjusting and one fine control. Digital specified, analog specified, pulse specified, pulse width specified, communication specified and others, which can be switched by many means at any time. | |
| | Binding function | Run command channel and frequency specified channel can bind together randomly and switch synchronously | |
| Input output characteristic | Digital input channel | Channel 8 for universal digital input, max. Frequency 1KHz, channel 1 can be used as pulse input channel, max. Input 50KHz, which can be expanded to channel 14 . | |
| | Analog input channel | Channel 2 for analog input channel, AI1 can choose 4~20mA or 0~10V output, AI2 is differential input channel, 4~20mA or -10~10V for option, which can be expanded to channel 4 analog input. | |
| | Pulse output channel | 0.1 ~ 20KHz pulse square signal output to achieve setting frequency, output frequency and other physical quantity output. | |
| | Analog output channel | Channel 2 for analog signal output, AO1 can choose 4~20mA or 0~10V, AO2 can choose 4~20mA or 0~10V to achieve setting frequency, output frequency and other physical quantity output, which can be expanded to channel 4 analog output. | |

| | | |
|---------------------|-------------------------|--|
| Unique function | Rapid current limit | Limit inverter over current to the greatest point, and make it run more stably |
| | Monopulse control | Suitable for working site where need one button to control inverter start and stop, first press to start, then press to stop, and that cycle repeats. Its very simple and reliable. |
| | Fixed length control | Realize fixed length control |
| | Timing control | Timing control function: setting time range 0.1Min ~ 6500.0Min |
| | Virtual terminal | Five group virtual input & output IO can realize simply logical control |
| Keypad | Keypad display | The parameters as setting frequency, output frequency, output voltage, output current can be displayed |
| | Button Locked | Lock all or part of the buttons |
| Protection function | | Motor power on Shot circuit test, input & output phase loss protection, over-current protection, over voltage protection, under voltage protection, over heat protection, overload protection, under load protection, relay absorption protection, terminal protection and no stop protection under power off. |
| Environment | Application site | Indoor, not bare to sunlight, no dust, no corrosive gas, no flammable gas, no vapor, no water drop or salt etc. |
| | Altitude | Under 1000 meter. (above 1000 meter require to reduce volume to use, output current reduce about 10% of rated current per 1000 meter high) |
| | Environment temperature | -10℃~+40℃ (environment temperature between 40℃~50℃, need to reduce volume or strengthen heat sink) |
| | Environment humidity | Smaller than 95%RH, no drop condenses |
| | Vibration | Smaller than 5.9 M/S ² (0.6g) |
| | Storage temperature | -40℃~+70℃ |
| structure | Protection grade | IP20 |
| | Cooling mode | Forced air cooling and natural |
| Installation mode | | Wall hanging and cabinet installation |



Note

To get a perfect usage performance of the inverter, Please check and select right type according to this chapter before wiring.



It is necessary to select right type, otherwise it may cause motor abnormal run or inverter damage.

3 Installation and wiring

3.1 Installation ambient

3.1.1 The demands for installation ambient

- (1) Installed in drafty indoor place, the ambient temperature should be within $-10^{\circ}\text{C}\sim 40^{\circ}\text{C}$, it needs external compulsory heat sink or reduce the volume if temperature is over than 40°C ; when temperature under -10°C , please preheat inverter first.
- (2) Avoid installing in places with direct sunlight, much dust, floating fiber and metal powder.
- (3) Don't install in place with corrosive, explosive gas.
- (4) The humidity should be smaller than 95%RH, without condensation water.
- (5) Installed in place of plane fixing vibration smaller than $5.9\text{m/s}^2(0.6\text{g})$.
- (6) Keep away from electromagnetic disturbance source and other electronic apparatus sensible to electromagnetic disturbance.

3.1.2 Installation direction and space

- (1) Normally the inverter should be mounted vertically, horizontal mounting will seriously affect heat dissipation and the inverter must be used in lower volume.
- (2) Demand for minimum mounting space and distance, please see Fig.3-1.
- (3) When installing multiple inverters up and down, leading divider must be applied between them, see fig. 3-2.

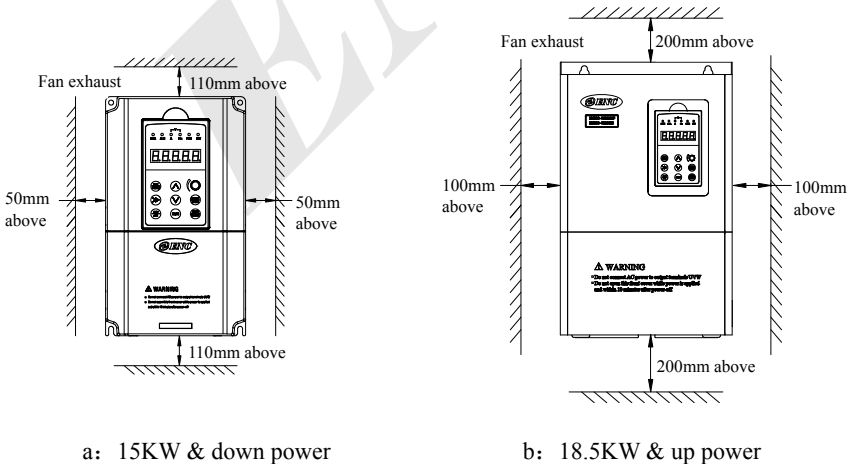

Fig.3-1 mounting space

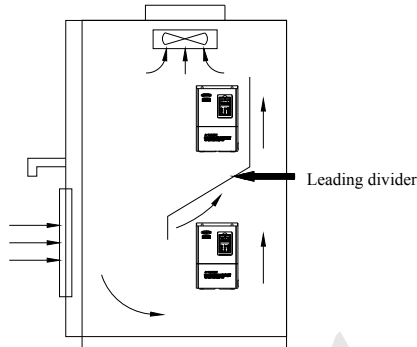

Fig.3-2 mounting of multiple inverters

3.2 Parts disassembly and installation

3.2.1 Keyboard disassembly and installation

(1) Disassembly

Let the forefinger press finger inlet on the keypad, depress fixing flexible plate on the top lightly, draw it outward, then you can disassemble the keypad.

(2) Assembly

First interface the fixed hook of on the bottom of keyboard with the keyboard installation claw of inverter, then press the fixed shrapnel on the top of keyboard to push it assemble well properly (keyboard assemble well when sounding of crisp), show as Fig.3-3.

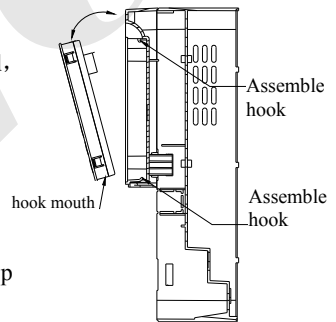

Fig.3-3 Keypad assembly

3.2.2 Cover disassembly and installation

3.2.2.1 Cover disassembly and installation

(1) Disassembly

Located the thumbs to the side bayonet, the ring fingers on the joint of the up and down cover, with thumbs press inside and pull upside at the same time until the bayonet open between cover and whole case, then pull back cover to make it off the inverter.

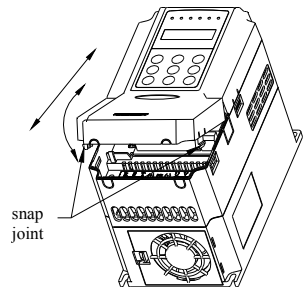

Fig.3-4 metal cover disassemble and assembly

(2) Assembly

- 1) tilt cover at 5~10 degree;
- 2) interface installation claw with hook on the top of inverter, press down heavily till cover bayonet enter into the holes of two side completely, show as Fig.3-4.

3.2.2.2 Metal cover disassembly and installation:

(1) Disassembly

First take off 2 screws at the side of the cover and move it a bit outward horizontally, then tilt it at 15 degree and draw it outward at the direction shown in right figure, now you can take the cover off.

(2) Assembly

First put down the cover in parallel with unit body and make it just locked at two sides of the inverter, secondly force it ahead and make fixing part on its top inserted into fixing slot of unit body, at last screw the cover and finish assembly for the cover.

As shown in Fig.3-5

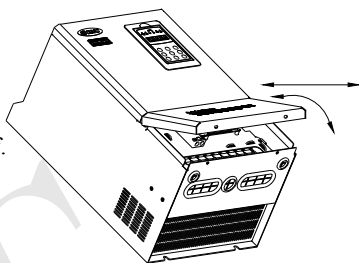

Fig.3-5 metal cover disassemble and assembly

3.3 Wiring notice points

- (1) Assure power be cut off completely for above 10 minutes before wiring, otherwise there is danger of getting electric shock.
- (2) Forbid connecting power wire to output U, V, W of the inverter.
- (3) If there is current leakage inside inverter, inverter and motor must be earth grounding for safety assurance, please refer to clause 8 in Chapter 3.4.1 for grounding wiring.
- (4) Before shipment compression resistance test of the inverter is Passed, so users should not conduct compression resistance test again.
- (5) Do not add absorbing capacitor or other resistance-capacitor absorbing device between inverter and motor; also do not add electromagnetic contact. If contactor and other switch component needed to add, please make sure inverter suspended without output, show as Fig.3-6
- (6) To provide inverter over-current protection in output side and convenient maintenance under power off, it should be connected to power source through air switch and contactor.
- (7) Control signal wire should select multicore stranded wire or shielding wire. One end of the shielding layer hang in the air, and the other end connect to inverter earth grounding terminal, connection wire shorter than 20m.





- (1) Before wiring, assure power supply is cut off completely for 10 minutes and all LED or LCD indicator light extinguished.
- (2) Before inverter internal wiring, confirm that DC volt. Between main loop end P+ and P- fall down to below DC36V.
- (3) Wiring can only be done by professional person trained and qualified.
- (4) Before power on, check if voltage grade of the inverter is in line with that of power supply volt., otherwise will cause personnel injured and device damaged.

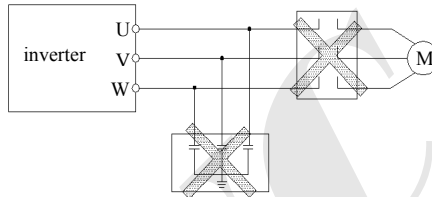

Fig.3-6 Forbid to use contactor and absorbing capacitor

3.4 Main loop terminal wiring

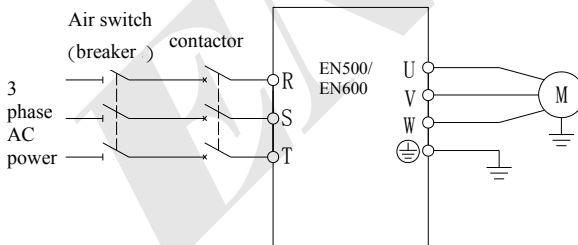

Fig.3-7 main loop simple wiring

To keep user power grid safety, please choose proper air switch, breaker, wiring at power input side, parameter recommended show as Table 3-1 (**Remark: wire must choose PVC insulation copper conductor**).

Table 3-1 parameter recommended for air switch (breaker), contactor and wire selection

| Type | Air switch or breaker (A) | Contactor (A) | Input power wire mm ² | Output motor cable mm ² | Control signal wire mm ² |
|---------------------|---------------------------|---------------|----------------------------------|------------------------------------|-------------------------------------|
| EN600-2S0004 | 6 | 9 | 0.75 | 0.75 | 0.5 |
| EN600-2S0007 | 10 | 12 | 0.75 | 0.75 | 0.5 |
| EN600-2S0015 | 16 | 18 | 1.5 | 1.5 | 0.5 |
| EN600-2S0022 | 16 | 18 | 1.5 | 1.5 | 0.5 |
| EN600-2S0037 | 20 | 25 | 2.5 | 2.5 | 0.75 |
| EN600-4T0007G/0015P | 6 | 9 | 0.75 | 0.75 | 0.5 |
| EN600-4T0015G/0022P | 10 | 12 | 0.75 | 0.75 | 0.5 |
| EN600-4T0022G/0037P | 16 | 18 | 1.5 | 1.5 | 0.5 |
| EN600-4T0037G/0055P | 16 | 18 | 1.5 | 1.5 | 0.5 |
| EN600-4T0055G/0075P | 20 | 25 | 2.5 | 2.5 | 0.75 |
| EN600-4T0075G/0110P | 25 | 25 | 4.0 | 4.0 | 0.75 |
| EN600-4T0110G/0150P | 32 | 32 | 6.0 | 6.0 | 0.75 |
| EN600-4T0150G/0185P | 40 | 40 | 6.0 | 6.0 | 0.75 |
| EN600-4T0185G/0220P | 50 | 50 | 10 | 10 | 1.0 |
| EN600-4T0220G/0300P | 50 | 50 | 10 | 10 | 1.0 |
| EN600-4T0300G/0370P | 63 | 63 | 16 | 16 | 1.0 |
| EN600-4T0370G/0450P | 80 | 80 | 25 | 25 | 1.0 |
| EN600-4T0450G/0550P | 100 | 115 | 35 | 35 | 1.0 |
| EN600-4T0550G/0750P | 125 | 125 | 50 | 50 | 1.0 |
| EN500-4T0750G/0900P | 250 | 160 | 70 | 70 | 1.5 |
| EN500-4T0900G/1100P | 250 | 160 | 75 | 75 | 1.5 |
| EN500-4T1100G/1320P | 350 | 350 | 120 | 120 | 1.5 |
| EN500-4T1320G/1600P | 400 | 400 | 120 | 120 | 1.5 |
| EN500-4T1600G/2000P | 500 | 500 | 150 | 150 | 1.5 |
| EN500-4T2000G/2200P | 630 | 630 | 185 | 185 | 1.5 |
| EN500-4T2200G/2500P | 700 | 700 | 240 | 240 | 1.5 |
| EN500-4T2500G/2800P | 800 | 800 | 120*2 | 120*2 | 1.5 |
| EN500-4T2800G/3150P | 800 | 800 | 120*2 | 120*2 | 1.5 |
| EN500-4T3150G/3550P | 1000 | 1000 | 150*2 | 150*2 | 1.5 |
| EN500-4T3550G/3750P | 1000 | 1000 | 185*2 | 185*2 | 1.5 |
| EN500-4T3750G/4000P | 1250 | 1250 | 240*2 | 240*2 | 1.5 |
| EN500-4T4000G/4500P | 1250 | 1250 | 240*2 | 240*2 | 1.5 |
| EN500-4T4500G/5000P | 1250 | 1250 | 270*2 | 270*2 | 1.5 |
| EN500-4T5000G/5600P | 1600 | 1600 | 270*2 | 270*2 | 1.5 |
| EN500-4T5600G/6300P | 1600 | 1600 | 300*2 | 300*2 | 1.5 |
| EN500-4T6300G | 2000 | 2000 | 300*2 | 300*2 | 1.5 |

3.4.1 Connection between inverter and fitting parts

(1) Breaking device like isolation

Switch must assemble between power source and inverter to keep persona safety under repairing and inverter requirement for compulsory power off.

(2) There must be over-current

Protection breaker or fuse in inverter power supply circuit to avoid failure expanding because of the second device failure.

(3) AC input reactor

When high harmonics between inverter and power supply is strong which cannot meet system requirement or input side power factor need to improve, ac input reactor can be added.

(4) Contactor is used to power supply only, do not use it to control inverter start and stop.

(5) Input side EMI filter

hoosing optionally EMI filter to restrain high frequency transduction interference and radio-frequency interference from inverter power line.

(6) Output side EMI filter

Choosing optionally EMI filter to restrain radio-frequency Interference and wire leakage current from inverter output side.

(7) AC output reactor

Installing AC output reactor is suggested to avoid motor insulation damage, oversize current leakage and inverter frequent protection when connecting wire between inverter and motor exceeds 50m.

(8) Safety earth ground wire

Inverter and motor must be earth ground connection, connection wire should select as shorter and thicker as above 3.5mm² multicore copper wire, and earth grounding resistance smaller than10Ω.

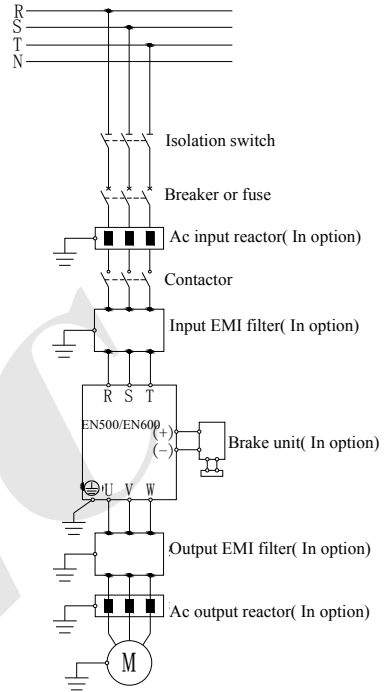
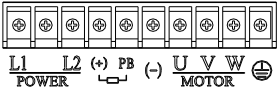



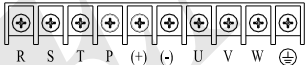

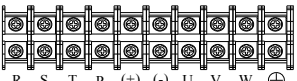
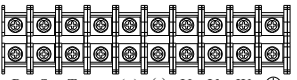



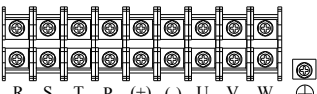

Fig.3-8 connection of inverter and fitting parts

3.4.2 Main loop terminal wiring

(1) Main loop input output terminal show as table 3-2, 3-3.

Table 3-2 EN600 main loop input output terminal description

| Adapted type | Main loop terminal | Terminal name | Function description |
|---|--|---|---|
| EN600-2S0004 ~ EN600-2S0037 |  | L1、L2 | 1 phase AC input terminal, connect power source |
| | | (+) | DC volt. Positive terminal |
| | | PB | External connect to brake resistor reverse terminal |
| | | (-) | DC volt. Negative terminal |
| | | U、V、W | 3 phase AC output terminal, connect to motor |
| | |  | Grounding terminal |
| EN600-4T0007G/0015P ~ EN600-4T0150G/0185P |  | R、S、T | 3 phase AC input terminal, connect power source |
| | | (+) | DC volt. Positive terminal |
| | | PB | External connect to brake resistor reverse terminal |
| | | (-) | DC volt. Negative terminal |
| | | U、V、W | 3 phase AC output terminal, connect to motor |
| | |  | Grounding terminal |
| EN600-4T0185G/0220P EN600-4T0220G/0300P | <p>Terminal 1:</p>  <p>Terminal 2:</p>  | R、S、T | 3 phase AC input terminal, connect power source |
| | | P、(+) | External connect to DC reactor |
| | | (+) | DC volt. Positive terminal |
| | | PB | External connect to brake resistor reverse terminal |
| | | (-) | DC volt. Negative terminal |
| | | (+)、(-) | External connect brake unit |
| | | U、V、W | 3 phase AC output terminal, connect to motor |
| | |  | Grounding terminal |
| | | EN600-4T0300G/0370P EN600-4T0370G/0450P | <p>Terminal 1:</p>  <p>Terminal 2:</p>  |
| P、(+) | External connect to DC reactor | | |
| PB | External connect to brake resistor reverse terminal | | |
| (+) | DC volt. Positive terminal | | |
| (-) | DC volt. Negative terminal | | |
| (+)、(-) | External connect brake unit | | |
| U、V、W | 3 phase AC output terminal, connect to motor | | |
|  | Grounding terminal | | |

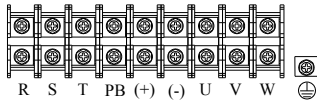
| | | | | |
|--|--|--|---|--|
| EN600-4T0450G/0550P EN600-4T0550G/0750P | Terminal 1:  | R、S、T | 3 phase AC input terminal, connect power source | |
| | | P、(+) | External connect to DC reactor | |
| | | PB | External connect to brake resistor reverse terminal | |
| | | (+) | DC volt. Positive terminal | |
| | | (-) | DC volt. Negative terminal | |
| | | (+)、(-) | External connect brake unit | |
| | | U、V、W | 3 phase AC output terminal, connect to motor | |
| | |  | Grounding terminal | |
| | | Terminal 2:  | | |

Note:

- ① EN600-4T0185G/0220P~EN600-4T0550G/0750P there are two kinds of sort order for main loop terminal, terminal 2 remove “P”, add “PB” terminal.
- ② EN600-4T0185G/0220P~EN600-4T0550G/0750P (terminal 1) short circuit diagram of copper bar assembly on main loop terminal

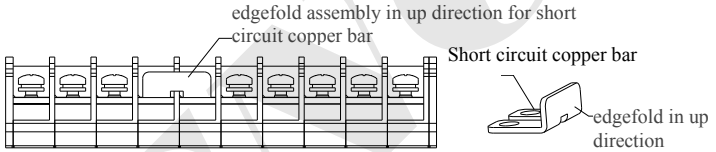
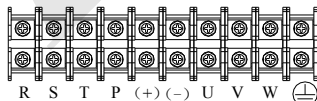





Table 3-3 EN500 main loop input output terminal description

| Adapted type | Main loop terminal | Terminal name | Function description |
|---|---|---|---|
| EN500-4T0750G/0900P |  | R、S、T | 3 phase AC input terminal, connect power source |
| | | (+) | DC volt. Positive terminal |
| | | (-) | DC volt. Negative terminal |
| | | P、(+) | External connect to DC reactor |
| | | (+)、(-) | External connect brake unit |
| | | U、V、W | 3 phase AC output terminal, connect to motor |
| | |  | Grounding terminal |
| EN500-4T0900G/1100P ~ EN500-4T1320G/1600P |  | R、S、T | 3 phase AC input terminal, connect power source |
| | | (+) | DC volt. Positive terminal |
| | | (-) | DC volt. Negative terminal |
| | | (+)、(-) | External connect brake unit |
| | | U、V、W | 3 phase AC output terminal, connect to motor |
| | |  | Grounding terminal |

| | | |
|---|--|--|
| EN500-4T1600G/2000P ~ EN500-4T2200G/2500P | | R, S, T 3 phase AC input terminal, connect power source (+) DC volt. Positive terminal (-) DC volt. Negative terminal (+) 、 (-) External connect brake unit U, V, W 3 phase AC output terminal, connect to motor Grounding terminal |
| EN500-4T2500G/2800P ~ EN500-4T4000G/4500P | | R, S, T 3 phase AC input terminal, connect power source (+) DC volt. Positive terminal (-) DC volt. Negative terminal (+) 、 (-) External connect brake unit U, V, W 3 phase AC output terminal, connect to motor Grounding terminal |
| EN500-4T4500G/5000P ~ EN500-4T6300G | | R, S, T 3 phase AC input terminal, connect power source (+) DC volt. Positive terminal (-) DC volt. Negative terminal (+) 、 (-) External connect brake unit U, V, W 3 phase AC output terminal, connect to motor Grounding terminal |



1. The wiring of main loop must connect right according to the description above. Wrong wiring will cause device damage and personal injury.
2. Short circuit copper bar assembly for 18.5KW and up power (terminal 1) for EN600 must be edgefold in up direction, or it will cause device damage and personal injury in the reverse direction.

3.5 Basic running wiring diagram

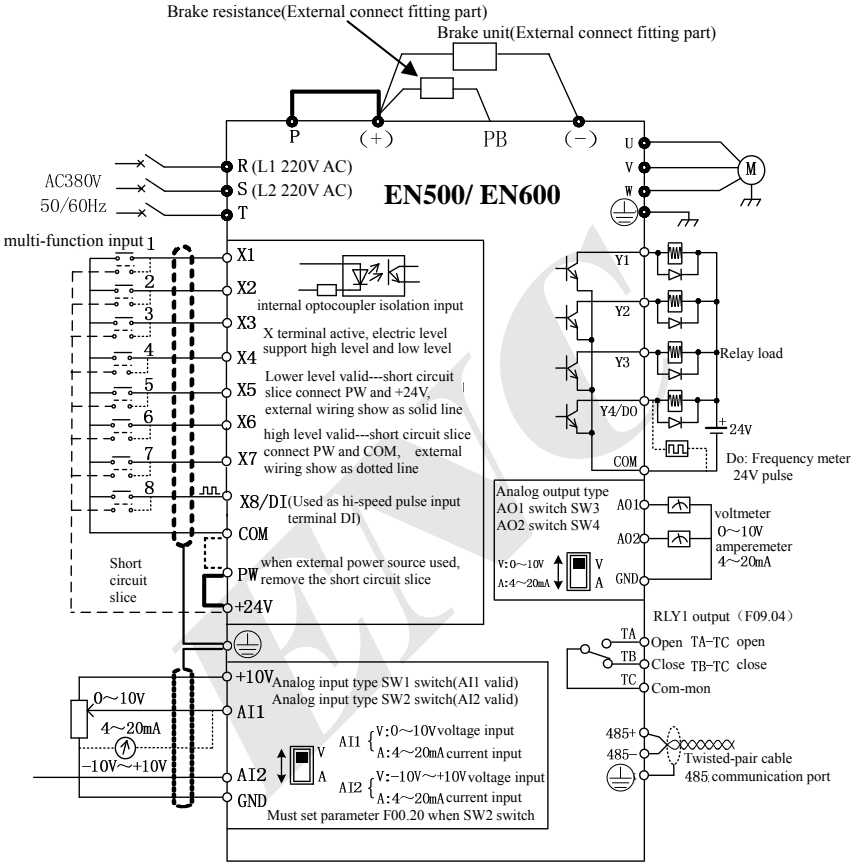

Fig.3-9 basic wiring diagram

Note: When connect to external DC reactor, it need to remove the short-circuit copper bar between P and (+) .

3.6 Control loop collocation and wiring

3.6.1 Relative location and function for control board terminal and slide switch:

Control board terminal and slide switch location show as Fig 3-10.

The terminal CN1 and CN7 are used by the manufacturers, CN2 is extended

interface, CN5 is for keypad, The CN3,CN4 and CN6 for users can be seen in table 3-4, The setting description and function of slide switch check table3-5. Please read the following descriptions carefully before using inverter.

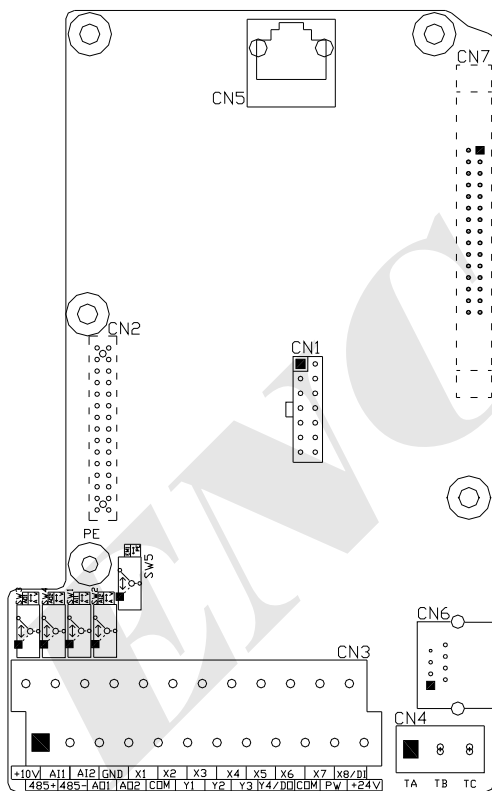









Fig.3-10 sketch map of CPU board

Table 3-4 function description of terminal provided for user

| No. | Function | Description |
|-----|---|--|
| CN3 | Input and output control of external terminal | To use when inverter run under external terminal control , refer to 3.6.2 |
| CN4 | Signal output of RLY1 | TA-TC is normal open contact; TB-TC is normal closed contact, refer to 3.6.2 |

| | | |
|-----|-------------------------------------|---|
| CN6 | CrystalRS485communication interface | To use when inverter through 485 communication can achieve cascade connection and other control, refer to 3.6.2 |
|-----|-------------------------------------|---|

Table 3-5 Slide switch function description for users

| No. | Function | Setting | Default value |
|-----|---------------------------------------|--|-----------------------------|
| SW1 | AI1 Analog input signal selection |  V: F00.20 be XXX0 0~+10V voltage signal input  I: F00.20 be XXX1 4~20mA current signal input | F00.20 be 0000 0~+10V |
| SW2 | AI2 Analog input signal selection |  V: F00.20 be XX0X, -10V~+10V voltage signal input  I: F00.20 be XXI X, 4~20mA current signal input | F00.20 be 0000 -10V~+10V |
| SW3 | AO1 Analog output signal selection |  V: F00.21 be XX00 0~+10V voltage signal output | F00.21 be 0000 0~+10V |
| SW4 | AO2 Analog output signal selection |  I: F00.21 be XX11 4~20mA current signal output | |
| SW5 | EMI inhibition for selection terminal |  : earth grounding  : suspending | suspending |



Note

(1) In the graphic of slide switch, black square means switch slidable location.

(2) Only when heavy interfering exist on working site, it's suggested to put EMI dial switch to earth grounding location, and  should connect to the earth.

3.6.2 Descriptions for control board terminal

(1) CN3 and CN4 terminal layout as following

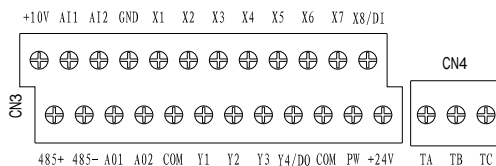

(2) CN3 and CN4 terminal function description show as Table 3-6

Table 3-6 function table for control board terminal

| Type | Symbol | Description | Terminal Function and specification |
|--------------------------------|--------|--|---|
| Multifunction input terminal | X1 | Multifunction input 1 | Input voltage range: 15~30V; Opto coupler isolation, Compatible with bipolar input; Input impedance: 4.7K Ω max input frequency: 1KHz |
| | X2 | Multifunction input 2 | |
| | X3 | Multifunction input 3 | |
| | X4 | Multifunction input 4 | |
| | X5 | Multifunction input 5 | |
| | X6 | Multifunction input 6 | |
| | X7 | Multifunction input 7 | |
| | X8/DI | Multifunction input 8/ high-speed pulse input | Except for X1~X7 function, it can be used as hi-speed pulse input. Input impedance: 2.2K Ω max input frequency: 50KHz |
| Power source | +24V | +24V power source | Provide +24V power to external device (24 \pm 4V) Max output current: 200mA |
| | PW | External power source input | factory default connect to +24V; when use external signal to drive X terminal, it need to connect to external power source and cut off with +24V power terminal. |
| | +10V | +10V power source | Provide +10V power to external device (10 \pm 0.5V) Max output current:50mA |
| | COM | Common interface | Reference ground for digital signal and +24V power |
| | GND | Common interface | Reference ground for analog signal and +10V power |
| Analog input | AI1 | Analog input 1 | Input range: DC 0V~10V/4~20mA, selected by SW1 dial switch on control board. Input impedance: voltage input at 20K Ω ; current input at 250 Ω . resolution: 1/4000 |
| | AI2 | Analog input 2 | Input range: DC-10V~10V/4~20mA, selected by the second figure of F00.20 and SW2 dial switch on control board. Input impedance: voltage input at 20K Ω ; current input at 250 Ω . resolution: 1/2000 |
| Analog output | AO1 | Analog output 1 | Voltage or current output is selected by SW3 (AO1) and SW4 (AO2) dial switch on control board. Output voltage range: 0~10V Output current range: 4~20mA |
| | AO2 | Analog output 2 | |
| Multi-function output terminal | Y1 | Open circuit collector output 1 | Opto coupler isolation output, unipolar Open circuit collector output Max voltage output: 30V Max current output: 50mA |
| | Y2 | Open circuit collector output 2 | |
| | Y3 | Open circuit collector output 3 | |

| | | | |
|-------------------------|-------|---|---|
| | Y4/DO | Open circuit collector output 4/ High-speed impulse output | Function code F00.22 to select terminal output mode When Open circuit collector output, with the same spec as terminal Y. When High-speed impulse output, the max frequency is 20KHz. |
| RLY1 output | TB—TC | Normal closed terminal | Contact capacity: AC250V/2A (cosφ=1) AC250V/1A (cosφ=0.4) DC30V/1A |
| | TA—TC | Normal open terminal | |
| Communication interface | 485+ | 485 differential signal interface | 485 differential signal positive terminal |
| | 485- | | 485 differential signal negative terminal |
| Auxiliary interface | CN2 | retain | |
| | CN6 | StandardRS485 communication interface | Twisted-pair cable or shield wire to connect |

(3) RS485 crystal outlet CN6 layout as following



| RS485 terminal CN6 layout | | | | | | | | |
|---------------------------|------|------|---|---|---|---|---|---|
| No. | 1 | 2 | 3 | 4 | 5 | 6 | 7 | 8 |
| Name | 485+ | 485- | - | - | - | - | - | - |

3.6.3 Analog input&output terminal wiring

(1) AI1 receive analog voltage or current signal single-ended input, switch through SW1, wire as below:

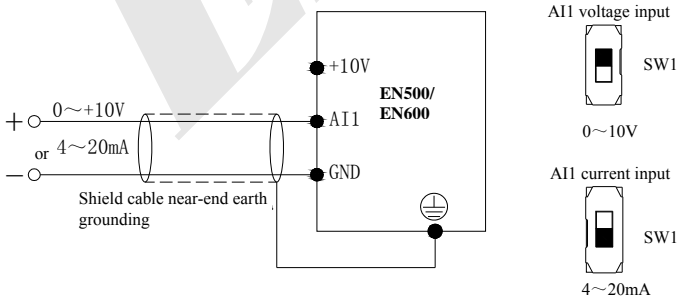

Fig.3-11 AI1 terminal wiring diagram

(2) AI2 receive analog voltage or current signal single-ended input, switch through SW2, and should match it with exact second figure of F00.20 setting, wire as below:

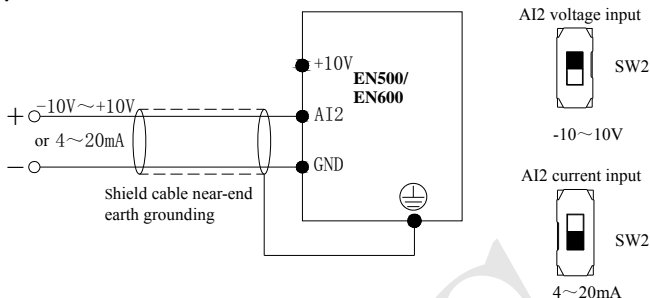

Fig.3-12 AI2 terminal wiring diagram

(3) AO1,AO2 terminal can connect to external analog meter, which can indicate several physical quantity, it can select analog voltage or current signal output, and switch through SW3 and SW4, wire as below:

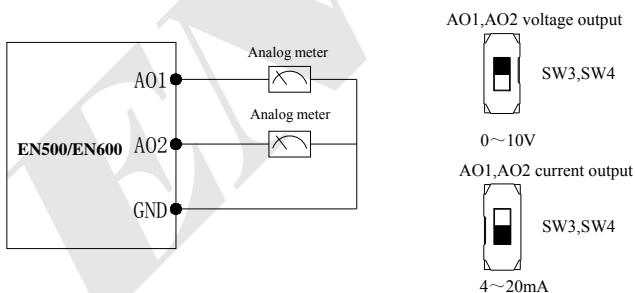

Fig.3-13 AO1,AO2 terminal wiring diagram



Note

- (1) Under analog input mode, filter capacitor or common mode choke can be installed between AI1 and GND or AI2 and GND.
- (2) Analog input and output signal can be interfered easily by ambient environment, it need use shield cable for connection and earth grounding well as short as possible.

3.6.4 Digital input terminal wiring

(1) To use inverter inbuilt $+24V$ power supply, and NPN source type external controller connection mode.

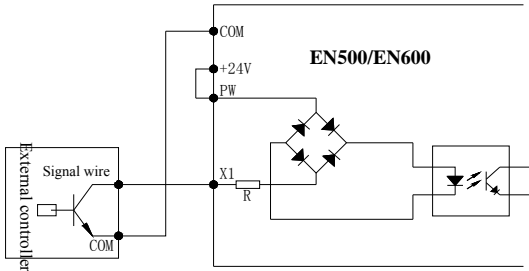

Fig.3-14 inbuilt 24V source type connection mode

(2) To use inverter inbuilt +24V power supply, and PNP drain type external controller connection mode.

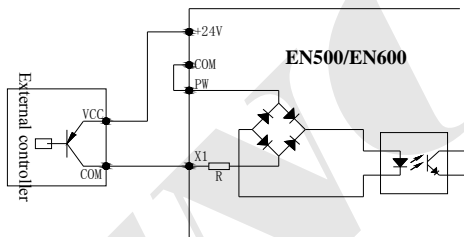

Fig.3-15 inbuilt 24V drain type connection mode

(3) To use external DC 15~30V power supply, and NPN source type external controller connection mode. (remove the short circuit slice between PW and +24V) .

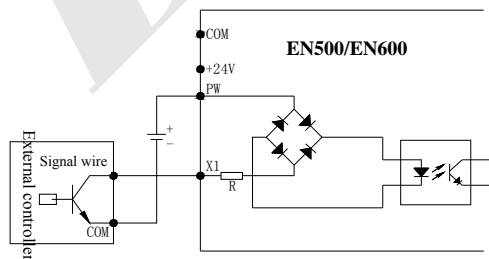

Fig.3-16 external power supply source type connection mode

(4) To use external DC 15~30V power supply, and PNP drain type external controller connection mode. (remove the short circuit slice between PW and +24V)

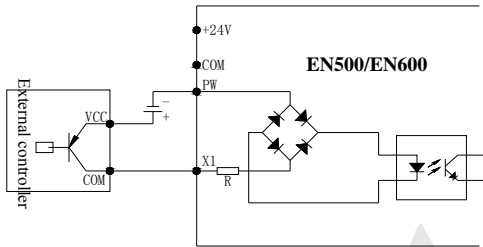

Fig.3-17 External power supply drain type connection mode

3.6.5 Communication terminal wiring

EN500/EN600 inverter provide RS485 serial communication interface to user. The following wire connection can make up of single-main single-sub control system or single-main multi-sub control system. To use host computer softwar(PC or PLC controller) can realize real time monitoring and operation to inverter, and to achieve complicated run control like long-distance control, high degree automation. It can also use a host inverter and the other slave inverter to make up of the cascade or synchronous control inverter network.

(1) Inverter RS485 interface and other device with RS485 interface wire connection show as following

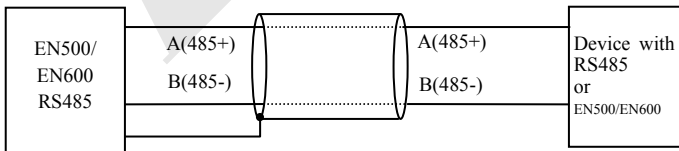

Fig.3-18 Communication terminal wiring

(2) Inverter RS485 interface and host computer (device with RS232 interface) connection:

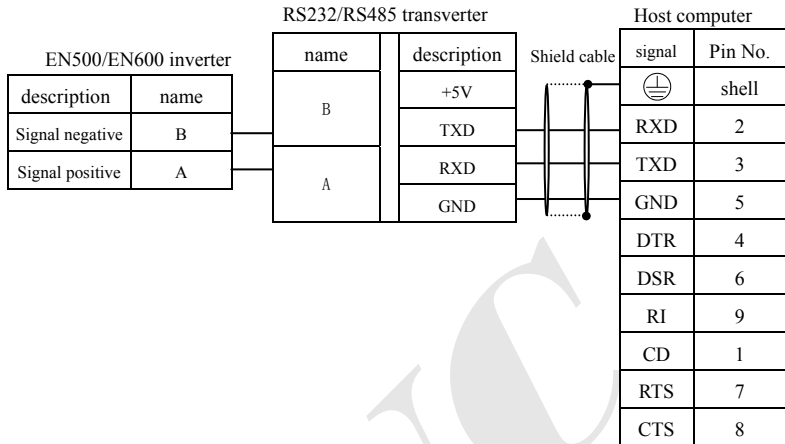

Fig.3-19 RS485 communication wiring

4 EMC (Electromagnetic compatibility) explanation

Because of inverter working principal resulting in electromagnetic noise, and to avoid or reduce inverter interference to ambient environment, this chapter introduce installation means to restrain interference from aspect of interference restrain, field wiring, system earth grounding, leakage current and power filter usage. Inverter will have good electromagnetic compatibility under general industrial environment, when user install the inverter according to this chapter.

4.1 Noise interference restraining

Inverter interference generating for run may have effect to nearby electronic device and the effect depend on the inverter installation surrounding electromagnetic environment and the restrain interference ability of the device.

4.1.1 Interference noise type

Because of inverter working principle, there are mainly 3 kinds of noise interference source::

- (1) circuit conduction interference;
- (2) space emission interference;
- (3) electromagnetic induction interference;

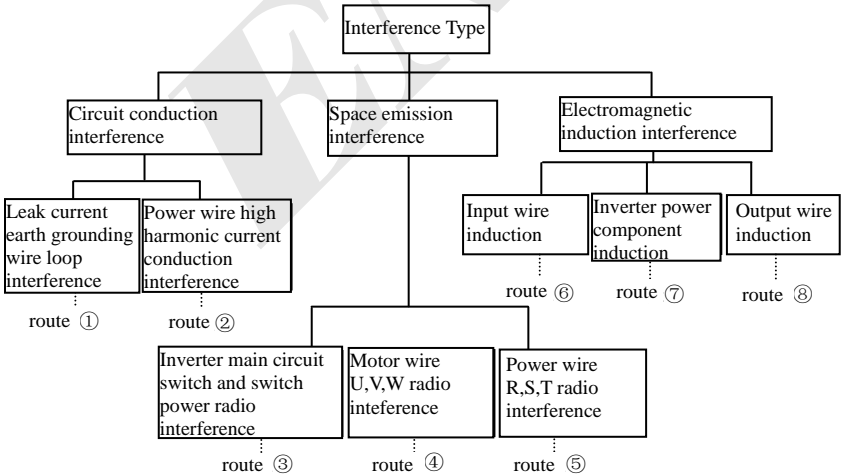

Fig.4-1 interference noise type

4.1.2 Basic countermeasure for restrain interference

Table 4-1 interference restrain countermeasure

| Noise spread road | Countermeasure of weakening effect |
|-------------------|---|
| ① | Earth grounding cable of peripheral device and inverter wiring make up of the closed-loop and leakage current of inverter earth grounding cable will make device perform wrong action. It will decrease wrong action when device not connect to earth grounding. |
| ② | When the power of peripheral device and inverter power belong to the same power source, high harmonic generating from inverter will transmit the voltage and current along with the power line which will interfere other devices within the same power source system. Take some restraining measures as below: install electromagnetic noise filter at inverter input end; use isolation transformer to isolate other devices; connect power end of peripheral device to remote power grid; add power ferrite filter magnetic ring to inverter R、S、T three phase wire to restrain high harmonic current conduction |
| ③④⑤ | <ul style="list-style-type: none"> ● Keep other sensitive devices and signal wire installed away from inverter. it should use shield wire and make the shield layer single end earth grounding. Besides keep distance from inverter and its input & output wire as possible as. When signal wire need to intersect with strong current cable, it should make them orthogonal crossing not parallel. ● Install high frequency noise filter (ferrite common code choke, also called magnetic ring) at the bottom end of the inverter input & output to restrain radio frequency interference of dynamic wire effectively. ● Motor cable should be placed in protective object with large thickness, such as placed in larger thickness(over 2mm) pipeline or buried in cemented tank. Putting dynamic wire in metal tube and connect to earth grounding with shield wire (motor cable use 4-core cable, one side is earthed through the inverter, the other side connected to motor casing). |
| ⑥⑦⑧ | To prevent wire parallel or bundled of strong and weak current, it should keep away from inverter assemble device, and wiring should away from inverter R,S,T,U,V,W equipower line. Devices with highfield and high magnetic field should notice the corresponding installation position of inverter and keep distance and orthogonal crossing. |

4.2 Field wiring and earth grounding

- (1) inverter terminal motor connection wire (U,V,W terminal output wire) and inverter terminal power connection wire (R,S,T terminal input wire) should keep distance enough as possible as can.
- (2) U,V,W terminal 3 motor wires should be placed in metal tube or metal wiring tank as possible as.
- (3) Generally control signal wire should use shield cable, when shield layer connect to inverter⊕ terminal, it should be the single end earth grounding which closed to inverter side.
- (4) Inverter⊕ terminal earth grounding cable must directly connect to floor, it cannot connect to earth grounding through other device, and the location of earth grounding should close to inverter as possible as.
- (5) strong current cable(R,S,T,U,V,W) cannot parallel wiring closely with control signal wire, and bundled together is prohibited. It should keep distance from over 20~60 cm (relative to strong current size). When it's necessary to intersect, it should be orthogonal crossing, show as Fig.4-2.

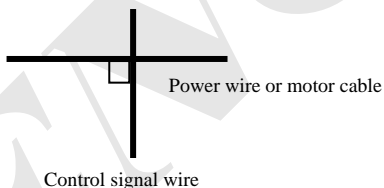

Fig.4-2 system wiring demand

- (6) earth grounding wire for strong current should separately connect to earth grounding with control signal and sensor earth grounding wire for weak current.
- (7) Forbid to connect inverter input terminal(R,S,T) to other devices.

4.3 Leak current and countermeasure

The leak current flows through inverter input and output terminal for wire capacitance and motor capacitance, and its size decided by the distributed capacitance and carrier frequency. There are two kinds of leak current: leak current to earth and wire-to-wire. Restraining methods as below:

- (1) diminish the cable length between inverter and motor.
- (2) install ferrite magnetic ring or output reactor at the inverter output terminal.



When reactor installed with rated voltage drop more 5% and long wiring to U, V, W terminal, it would reduce motor's voltage apparently. When motor run at full load, it is possible to flash motor, and it should be used by derating or boosting input and output voltage.

(3) as carrier frequency low, the motor noise would increase accordingly.

4.4 Installation demand for electromagnetic on-off electronic device

It should pay attention that surge absorber must be installed when electromagnetic on-off electronic device like relay, electromagnetic contactor and electromagnetic iron generating noise easily and largely installed near to inverter or in the same control cabinet, show as Fig. 4-3.

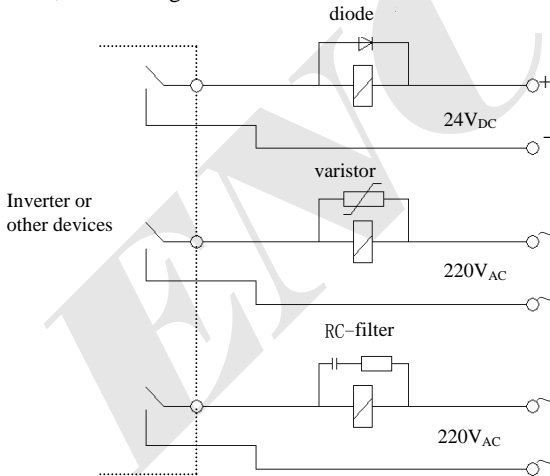

Fig.4-3 install demand for electromagnetic on-off device

4.5 Noise filter installation instructions

- (1) To use strictly as per the rated value; filter metal casing grounding must connect reliably to assemble cabinet metal grounding in large scale and it required good conductive continuity. Otherwise, it may cause electric shock and influence the EMC effect seriously.
- (2) Filter grounding terminal and inverter (⊕) terminal must connect to the same common earth grounding, otherwise it will influence the EMC effect seriously.
- (3) Filter installed as close as possible to inverter power input terminal.

5 Run and operation explanation for inverter

5.1 Run of inverter

5.1.1 Running order channels

There are 3 kinds of order channel for controlling run action of the inverter such as run, stop, jog etc.

0: keypad

Control by key , ,  on keypad (factory default).

1: Control terminal

Use control terminal FWD,REV,COM to make of double-line control, or use one terminal of X1~X8 and FWD or REV to make of three-line control.

2: Communication port

Control run and stop of the inverter through upper machine or other device which can communicate with the inverter.

Choose order channel by setting function code F01.15; and also can choose by multi-function input terminal (F08.18~F08.25 choose function 49,50,51,52,53).

Also can reach switch the command channel through multi-function key  (Only parts of optional keyboards are equipped with multi-functional key).



Please make switching debugging in advance when switch the order channel to check if it can fulfill system requirement, otherwise have danger of damaging device and injuring personal.

5.1.2 Frequency-provision channel

EN500/EN600 includes main frequency provision and assist frequency provision:

Main frequency provision:

0: keypad analog potentiometer provision;

1: AI1 analog setting;

2: AI2 analog setting;

3: terminal UP/DOWN adjustment provision;

4: communication provision(Modbus and external bus share a main frequency memory);

5: EA11 analog setting(extend effective);

6: EA12 analog setting(extend effective);

7: high speed pulse provision(X8 terminal need select the corresponding function);

8: terminal pulse width provision(X8 terminal need select the corresponding function);

9: terminal encoder provision(X1,X2 terminal connect to the encoder orthogonal input)

10~14: Reserved

Assist frequency provision:

0: keypad analog potentiometer provision;

1: AI1 analog setting;

2: AI2 analog setting;

3: terminal UP/DOWN adjustment provision;

4: communication provision(Modbus and external bus share a main frequency memory);

5: EA11 analog setting(extend effective);

6: EA12 analog setting(extend effective);

7: high speed pulse provision(X8 terminal need select the corresponding function);

8: terminal pulse width provision(X8 terminal need select the corresponding function);

9: terminal encoder provision(X1,X2 terminal connect to the encoder orthogonal input)

10~20: Reserved

5.1.3 Work state

Work state of EN500/EN600 includes of Waiting state, Running state and Parameter setting state.

Waiting state :

If there is no running command after the inverter electrified or after stop command during running state, the inverter enters into waiting state.

Running state:

The inverter enters into running state after receiving run command.

Parameter setting state:

After receiving the parameter identification command, enter the parameter setting state, after turning into the shutdown state.

5.1.4 Run mode

EN500/EN600 inverter have 6 kinds of run mode, following is in turn according to their priority, jog run → closed-loop run → PLC run → multi-section speed run → swing frequency run → common run. Shown as Fig.5-1.

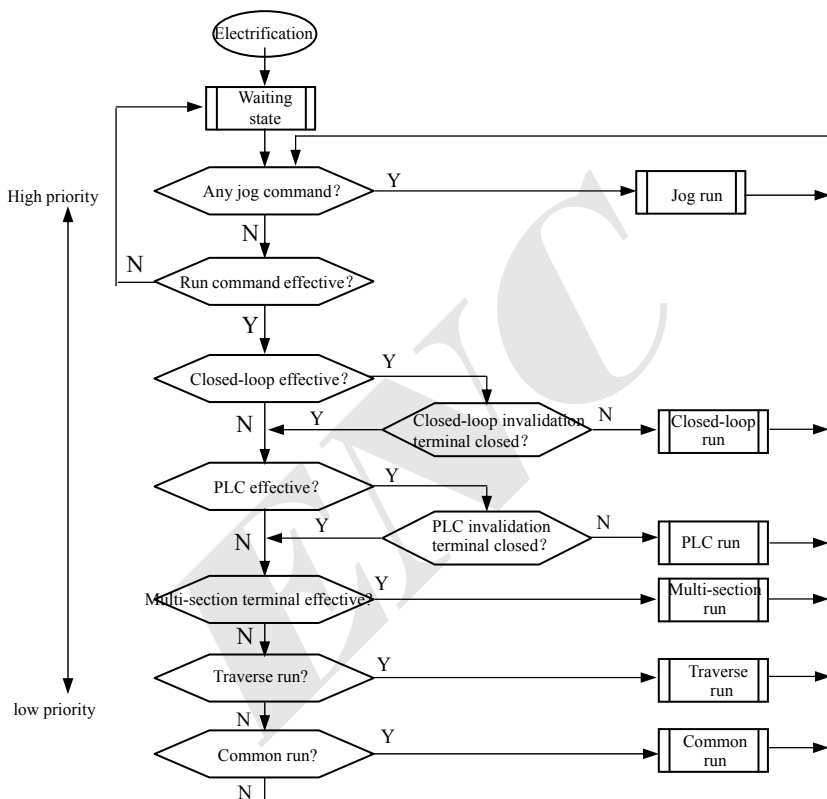



Fig.5-1 Run mode

0: Jog run

Upon receiving jog run command (for instance, press the  key on keypad) during waiting state, the inverter run at jog frequency (see function code F01.25~F01.29).

1: Closed-loop run

The inverter will come into closed-loop run mode when closed-loop run control

effective parameter is set($F11.00=1$ or $F12.00 \geq 1$). Namely carry on PID adjustment to specified value and feedback value(proportion integral differential calculation, see F11 group function code) and PID adjuster output is inverter output frequency. Can make closed-loop run mode ineffective and switch to lower level run mode by multi-function terminal (function 31).

2: PLC run

The inverter will enter into PLC run mode and run according to run mode preset(see F10 group function code description) through setting PLC function effective parameter($F10.00$ last bit $\neq 0$). Can make PLC run mode ineffective and switch to lower level run mode by multi-function terminal (function 36).

3: multi-section speed run

By nonzero combination of multi-function terminal(5,6,7,8,function), choose multi-section frequency 1~15($F10.31 \sim F10.45$) to run at multi-section speed.

4: swing frequency run

The inverter will enter into swing frequency run mode when swing frequency function effective parameter($F13.00=1$) is set. Set relevant swing frequency run special parameter according to textile swing frequency craft to realize swing frequency run.

5: common run

Common open loop run mode of general inverter.

In above 6 kinds of run mode except “jog run” the inverter can run according to kinds of frequency setting method.

5.2 Operation and use of key board

5.2.1 Keypad layout

The operating keyboard is the main unit of frequency inverter to accept commands, display parameters. Keyboard outline diagram shown in Figure 5-2.

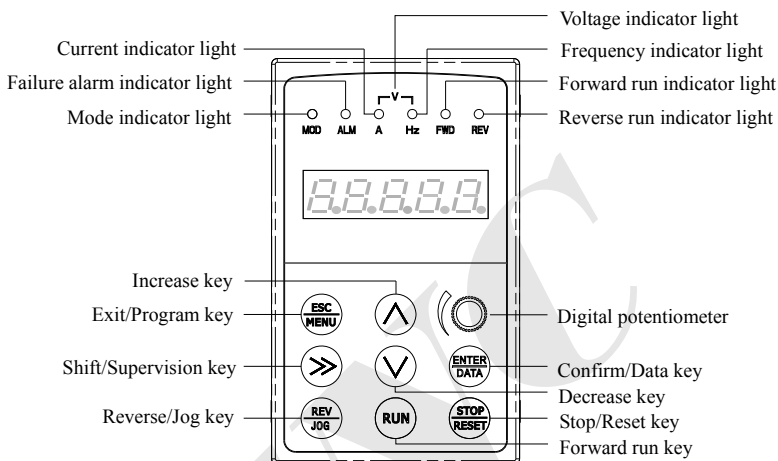





Fig.5-2 keypad layout sketch

5.2.2 Keypad function description

There are 9 key-presses on inverter keypad, and function definition of each key is as shown in table 5-1.

Table 5-1 keypad function table

| Key | Name | Function description |
|-----|--------------------------|---|
| | Program/Exit key | Enter into or exit programming state |
| | Shift/Supervision on key | Can choose modification digit of set data under editor state; can switch display status supervision parameter under other state |
| | Function/Data key | Enter into or exit programming state |
| | Rev/Jog key | Under keypad mode: to press this key can set reverse run or Jog run according to the 1 st bit of parameter F00.15 |
| | Run key | Enter into forward run under keypad mode |

| | | |
|---|-----------------------|---|
|  | Stop/reset key | In common run status the inverter will be stopped according to set mode after pressing this key if run command channel is set as keypad stop effective mode. The inverter will be reset and resume normal stop status after pressing this key when the inverter is in malfunction status. |
|  | Digital potentiometer | It is the same as the function of increase and decrease key, rotate to the left means decrease, rotate to the right means increase. |
|  | Increasing button | To increase data or function code (to press it continuously can improve increasing speed) |
|  | Decreasing button | To decrease data or function code (to press it continuously can improve decreasing speed) |

5.2.3 LED and indicator light

4 status indicator light: they are MOD(mode):ALM(alarm):FWD(forward run):REV(reverse run)from left to right on the LED: their respective indicating meaning is as shown in table 5-2.

Table 5-2 status indicator light description

| Item | | Function description | | |
|------------------|------------------------|--|---|---|
| Display function | Digital display | Display current run status parameter and set parameter | | |
| | Status indicator light | A, Hz, V | Unit for relevant current digital displayed physical parameter(for current is A:for voltage is V:for frequency is Hz) | |
| | | MOD | This indicator light is lit in non-supervision status and extinguished if no key pressed for a minute: then come back to supervision status | |
| | | ALM | Alarm indicator light: indicate that the inverter is in over current or over voltage suppressing status or failure alarm status currently | |
| | | FWD | Forward run indicator light, indicate that the inverter output forward phase order and the connected motor rotate in forward direction | The inverter work in DC brake status if FWD,REV indicator light is lit at the same time |
| | | REV | Reverse run indicator light: indicate that the inverter output reverse phase order and the connected motor rotate in reverse direction | |

5.2.4 Key board display status

EN500/EN600 keypad display status is classified as Waiting status parameter display; Function code parameter editing status display; Malfunction alarm status display; Run status parameter display; Alarm state display in total 5 kinds of status. LED indicator light will all be lit after the inverter electrified. Then enter into set frequency display. As shown in Fig.5-3 a

(1) Waiting parameter display status

The inverter is in waiting status and waiting status supervision parameter is displayed on keyboard: normally parameter F00.13 decide which status supervision parameter to be displayed. As shown in Fig.5-3 b, the indicator light shows the unit of the parameter.

To press (>>) key, it can display different waiting status supervision parameter circularly: for detail please see C-00 to C-05 group supervision parameter details decide by F00.07~F00.12.

(2) Run parameter display status

The inverter enters into run status when receiving effective run command and normally parameter F00.13 decide which status supervision parameter to be displayed on the keypad. As shown in Fig.5-3 c, the indicator light shows the unit of the parameter.

To press (>>) key can display run status supervision parameter circularly. For detail please see C-00 To C-05 group supervision parameter details decide by F00.01~F00.06 .

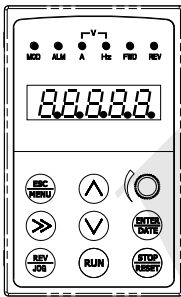

Fig.a Electrification, display 8.8.8.8.8.

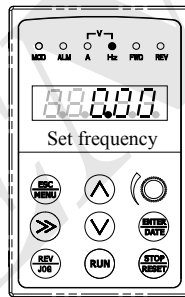

Fig.b waiting status, display waiting status parameter

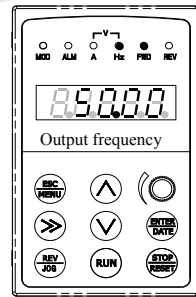

Fig.c run status: display run status parameter

Fig.5-3 inverter electrification: waiting: run status display

(3) Failure alarm display status

The inverter enters into failure alarm display status upon detecting failure signal and display failure code sparklingly(as shown in Fig.5-4);

To press (>>) key can look over relative parameter after stopping running;

Can press (ESC MENU) key to enter into program status to see about F26 group parameter if want to search

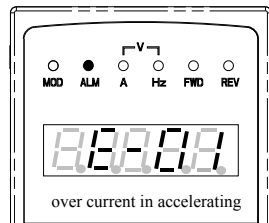

Fig.5-4





failure information.

Can carry on failure restoration by  key: control terminal or communication command on the keypad after troubleshooting. Keep displaying failure code if failure exist continuously.



For some serious failure, such as The earthing short circuit, Inverter modules protect, over current, over voltage etc., must not carry on failure reset forcibly to make the inverter run again without failure elimination confirmed. Otherwise have danger of damaging the inverter !

(4) Function code editing status

Under waiting, run or failure alarm status, press  key, can enter into editing status (If user password is set, can enter into editing status after inputting the password, see also F27.00 description and Fig.5-10), and editing status is displayed according to three classes menu mode, as shown in Fig. 5-5. To press  key can enter into one class by one class. Under function parameter display status, to press  key to carry on parameter storage operation; To press  key can only come back to upper class menu without storing modified parameter.

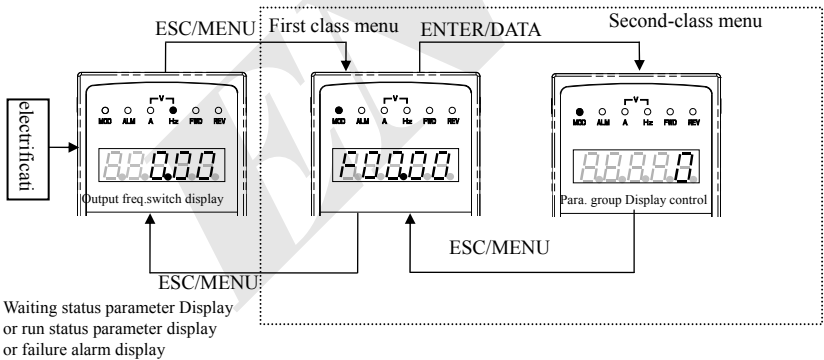

Fig.5-5 keypad display status switching

(5) Alarm state display

When under running and standby situation:
It means enter failure alarm display status upon detecting failure signal and display failure code sparklingly (Fig5-6) Inverter keeping running state But this alarm display can not be reset button eliminated: After only find the cause of the alarm: in order to eliminate

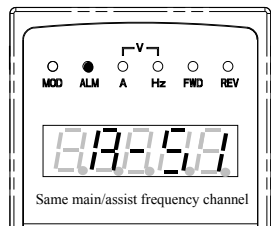

Fig.5-6

this factor Normal.

5.2.5 User Management Parameters

In order to facilitate the user parameter management: EN500/EN600 component model parameter menu for display management. The parameters do not need to be displayed can be shielded.

(1) Method parameter setting mode display.

By setting F00.00 = 0,1,2,3 respectively parameter mode is set: Basic menu mode: menu mode Intermediate: Advanced menu mode and user menu mode.

| | |
|--------------|---|
| Basic menu | F00,F01,F02,F03,F26 |
| Middle menu | F00,F01,F02,F03,F04,F05,F06,F07,F08,F09,F10,F11,F12,F13,F14,F15,F16,F18,F19,F26 |
| Advance menu | F00,F01,F02,F03,F04,F05,F06,F07,F08,F09,F10,F11,F12,F13,F14,F15,F16,F17,F18,F19,F20,F21,F22,F23,F24,F25,F26,F27 |
| User custom | F00.00 and F25 parameters group |

5.2.6 Method for operating keypad

Can carry on various operation to the inverter through keypad, for example:

(1) Status parameter display switching:

After pressing key (>>), display C group status supervision parameter; after displaying one supervision parameter code for 1 second will display this parameter value automatically. Press key (ENTER DATA) will go back to supervision interface.

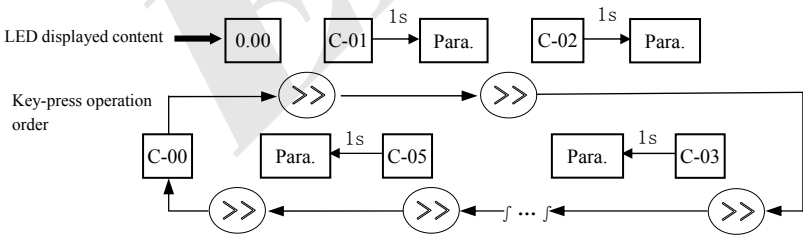

Fig.5-7 waiting status parameter display operating example

(2) Function code parameter setting

Take function code F01.01 modified from 5.00Hz to 6.00Hz as example.

Boldface in Fig.5-8 shows flickering digit.

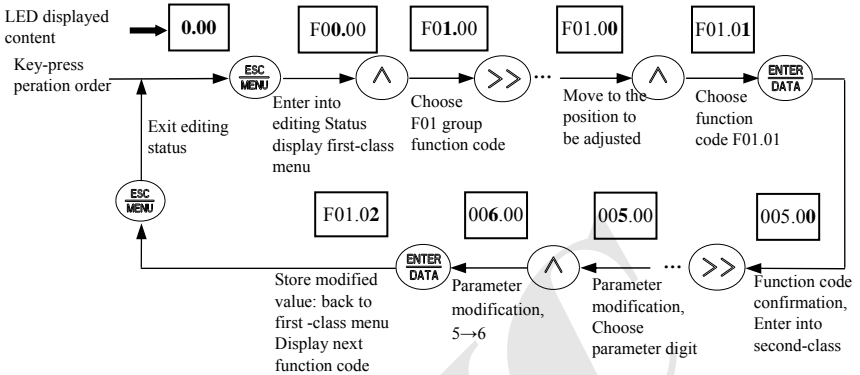

Fig.5-8 example for parameter setting and modification

Description: under second -class menu: if the parameter has no blinking digit, this function code can't be modified, possible reasons are as follows:

- 1> This function code shouldn't be modified: for example actual detected status parameter: run record parameter etc.;
- 2> This function code can't be modified under run status and can be changed after stopping running;
- 3> Parameter protected. All the function code can't be modified when function code F00.14=1 or 2, in order to avoid wrong operation. Need to set the function code F00.14 to 0 if you want to edit function code parameter.

(3) Specified frequency adjustment for common run

Take example modifying specified frequency from 50.00Hz to 40.00Hz at

F01.06=1, F01.03=0 during running for explanation.

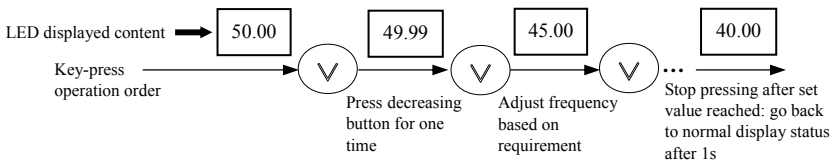

Fig.5-9 set frequency adjustment operation example

(4) Jog run operation

For example: keypad as current run command channel: jog run frequency 5Hz: waiting status.

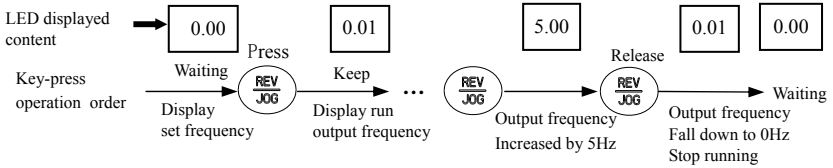

Fig.5-10 Jog run operating example

(5) Operation for entering to function code editing status after setting user password

For example :“User password” F27 is set to“12345”. Boldfaced digit in Fig.5-11 shows blinking bit.

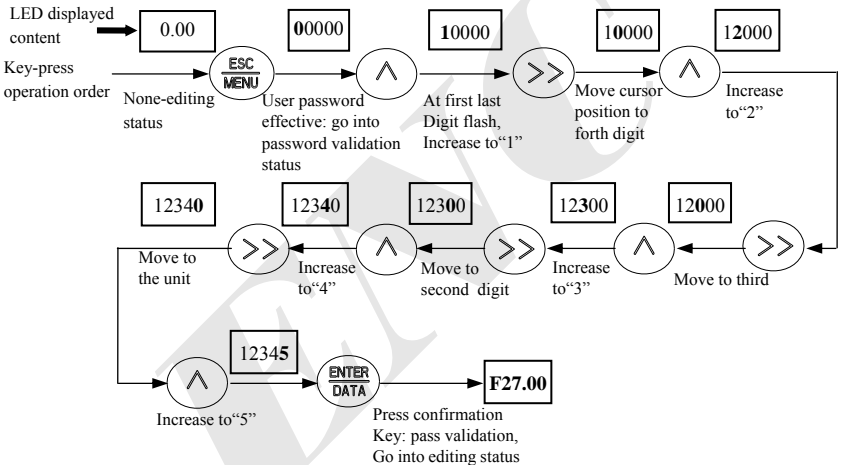

Fig.5-11 Inputting password to go into function code operation

(6) See about failure parameter under failure status:

If press (>>) key under failure status the user can quickly locate to the F26 group function code parameter. Press (>>) can quickly switch value between F26.04 ~ F26.10 parameters and fault alarm, easy to view the fault records.

(7) Keypad key-press locking operation

Under monitoring situation, To press (ENTER DATA) for 5s, the keyboard will display ‘LOCH1’, now the buttons on the keyboard are under locked. The detailed locked situation is decided by the value of hundred unit of F00.14.

(8) Keypad key-press unlocking operation

Under keypad-locked situation, press (ESC MENU) key for more than 5s to unlock the

keypad.

5.3 Inverter electrification

5.3.1 Check before electrification

Please carry on wiring based on operation requirement provided in “inverter wiring” of this Service manual.

5.3.2 First electrification

Close input side AC power supply switch after correct wiring and power supply confirmed: electrify the inverter and keypad LED display “8.8.8.8.8”, contactor closed normally: LED displayed set frequency shows that electrification is finished. First electrification operation process is shown as Fig.5-12:

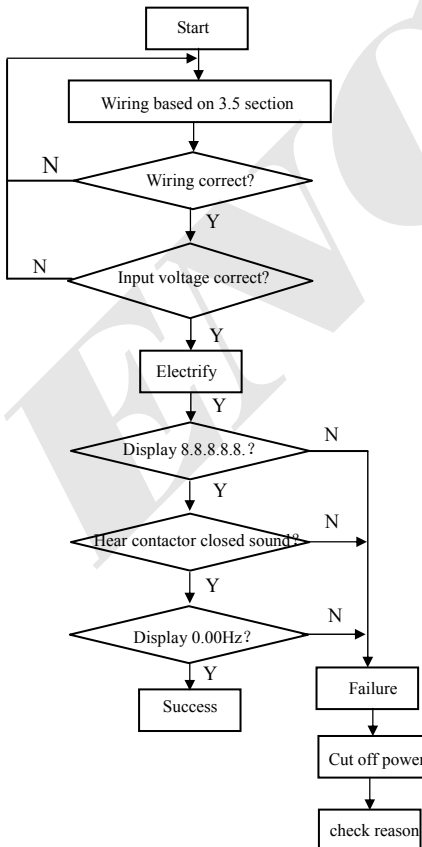

Fig.5-12 first electrification operation flow

6 Function parameter schedule graph

6.1 Symbol description









- × ---- parameter can't be changed in process of running
- ---- parameter can be changed in process of running
- * ---- read-only parameter, unmodifiable







6.2 Function parameter schedule graph

| F00—System Parameter Group | | | | | |
|----------------------------|---|---|-----------|-----------------|--------------|
| Function code | Name | Set range | Min. unit | Factory Default | Modification |
| F00.00 | Parameter group display control | 0: Basic list mode(only displayF00–F03 basic control parameter group and F26 fault record parameter group.) 1: Middle list mode. Display all parameter except for extension: virtual and reserve parameter group. 2: Senior list mode. All parameter display. 3: User list mode. Display parameter defined by user: and monitor parameter: F00.00 display all the time. | 1 | 2 | ○ |
| F00.01 | C-00 display parameter selection when operation | 0: main setup frequency (0.01Hz) 1: auxiliary setup frequency (0.01Hz) 2: setup frequency (0.01Hz) 3: output frequency (0.01Hz) 4: output current(0.1A) 5: output voltage(1V) 6: DC busbar voltage(0.1V) 7: motor speed(1 circle/min) 8: motor line velocity(1 circle/min) 9: inverter temperature(1℃) 10: run time already this time(0.1min) 11: current accumulate run time(1h) 12: current accumulate power-on time(1h) 13: inverter status 14: input terminal status 15: output terminal status 16: extension output terminal status 17: extension input terminal status 18: communication virtual input terminal status 19: internal virtual input node status 20: analog input AI1(after checkout) (0.01V / 0.01mA) 21: analog input AI2(after checkout) (0.01V / 0.01mA) 22: extension analog input EAI1(after checkout) (0.01V / 0.01mA) 23: extension analog input EAI2(after checkout) (0.01V / 0.01mA) 24: analog AO1 output(after checkout) (0.01V /0.01mA) 25: analog AO2 output(after checkout) (0.01V /0.01mA) 26: extension analog EAO1 output (0.01V /0.01mA) | 1 | 51 | ○ |

| | | | | | |
|--------|---|---|---|---|---|
| | | 27: extension analog EAO2 output(0.01V /0.01mA) 28: external pulse input frequency(before checkout) (1Hz) 29: Reserved 30: process PID provide(0.01V) 31: process PID feedback(0.01V) 32: process PID deviation (0.01V) 33: process PID output (0.01Hz) 34: simple PLC current segment No. 35: external multi-speed current segment No. 36: constant pressure water supply provide pressure (0.001Mpa) 37: constant pressure water supply feedback pressure (0.001Mpa) 38: constant pressure water supply relay status 39: current length(m/cm/mm) 40: accumulate length(m/cm/mm) 41: current internal count value 42: current internal time value(0.1s) 43: run command setup channel(0: keyboard 1: terminal 2: communication) 44: main frequency provide channel 45: auxiliary frequency provide channel 46: rated current(0.1A) 47: rated voltage(1V) 48: rated power(0.1KW) 49: Electric torque limit (0.1% Rated torque of motor) 50: Brake torque limit (0.1% motor rated torque) 51: frequency after Acce/Dece(0.01Hz) 52: motor rotor frequency(0.01Hz) 53: current given torque (percentage relative to rated torque, with direction) 54: current output torque(percentage relative to rated torque, with direction) 55: torque current at present(0.1A) 56: flux current at present(0.1A) 57: Setting motor rotate speed (r/min) 58: Output power (active power) (0.1KW) 59: the low digit of Total power consumption (1 kwh) 60: the high digit of Total power consumption(1 represents 10000 kwh) 61~65: Reserved | | | |
| F00.02 | C-01 display parameter selection when operation | Same as above | 1 | 2 | ○ |
| F00.03 | C-02 display parameter selection when operation | Same as above | 1 | 4 | ○ |
| F00.04 | C-03 display parameter selection when operation | Same as above | 1 | 5 | ○ |
| F00.05 | C-04 display parameter selection when operation | Same as above | 1 | 6 | ○ |
| F00.06 | C-05 display parameter selection when operation | Same as above | 1 | 9 | ○ |

6 Function parameter schedule graph

| | | | | | |
|--------|--|---|---|-----|---|
| F00.07 | C-00 display parameter selection when stop | Same as above | 1 | 2 | ○ |
| F00.08 | C-01 display parameter selection when stop | Same as above | 1 | 6 | ○ |
| F00.09 | C-02 display parameter selection when stop | Same as above | 1 | 48 | ○ |
| F00.10 | C-03 display parameter selection when stop | Same as above | 1 | 14 | ○ |
| F00.11 | C-04 display parameter selection when stop | Same as above | 1 | 20 | ○ |
| F00.12 | C-05 display parameter selection when stop | Same as above | 1 | 9 | ○ |
| F00.13 | Power-on fault monitor parameter selection | 0~5 | 1 | 0 | ○ |
| F00.14 | Parameter operation control | <p>Units digit: Parameter modification operations</p> <p>0: All parameters are allowed to be modified</p> <p>1: Except current parameter, all other parameters are not allowed to modify the</p> <p>2: Except F01.01, F01.04 and current parameter, all other parameters are not allowed to be modified</p> <p>Tens digit: Reset to factory defaults</p> <p>0: No action.</p> <p>1: All parameters return to default (not include fault record parameter group (F26 group) parameter).</p> <p>2: Except for motor parameter: all parameters return to default (not include F15 and F26 group parameter).</p> <p>3: Extension parameter return to default (only F21~F24 group parameter return to default).</p> <p>4: Virtual parameter return to default (only F20 group parameter return to default).</p> <p>5: Fault record return to default (only fault record parameter group (F26 group) parameter return to default)</p> <p>Hundreds digit: Key operation</p> <p>0: All locked</p> <p>1: Except  button: the others locked</p> <p>2: Except  ,  ,  button: the others locked</p> <p>3: Except  ,  button: the others locked</p> <p>4: Except  ,  button: the others locked</p> | 1 | 000 | × |

| | | | | | |
|--------|--|---|------|--------|---|
| F00.15 | Button function selection | <p>Units digit: panel  button selection</p> <p>0: Reversal command action button</p> <p>1: Jog action button</p> <p>Tens digit:  multi-function button function selection</p> <p>0: Invalid.</p> <p>1: Jog run.</p> <p>2: For/rev switching.</p> <p>3: Free stop.</p> <p>4: Switching to run command provide mode as the setup order of F00.16.</p> <p>5: Forward/Reverse Torque Switching</p> <p>6~9: Reserved</p> <p>Hundreds digit: terminal run command control</p> <p>0: Keyboard  button invalid</p> <p>1: Keyboard  button valid</p> <p>Thousands digit: communication run command control</p> <p>0: Keyboard  button invalid</p> <p>1: Keyboard  button valid</p> | 1 | 0001 | ○ |
| F00.16 | Multi-function key run command channel switching order selection | <p>0: Keyboard control→ terminal control→ communication control</p> <p>1: Keyboard control←→terminal control</p> <p>2: Keyboard control←→communication control</p> <p>3: Terminal control←→communication control</p> | 1 | 0 | ○ |
| F00.17 | Motor speed display coefficient | 0.1~999.9% | 0.1% | 100.0% | ○ |
| F00.18 | Line velocity display coefficient | 0.1~999.9% | 0.1% | 1.0% | ○ |
| F00.19 | Extended Port Parts set | <p>0: Invalid</p> <p>1: Reserved</p> <p>2: Multi pump water supply card</p> <p>3: Incremental PG encoder</p> <p>4~10: Reserved</p> | 1 | 0 | × |
| F00.20 | Analog input terminal configuration | <p>Units digit: AI1 configuration</p> <p>0: 0~10V input</p> <p>1: 4~20mA input</p> <p>Tens digit: AI2 configuration</p> <p>0: -10~10V input</p> <p>1: 4~20mA input</p> <p>Hundreds digit: EAI1 configuration</p> <p>0: 0~10V input</p> <p>1: -10~10V input</p> <p>2: 4~20mA input</p> <p>Thousands digit: EAI2 configuration</p> <p>0: 0~10V input</p> <p>1: -10~10V input</p> <p>2: 4~20mA input</p> | 1 | 0000 | × |
| F00.21 | Analog output terminal configuration | <p>Units digit: AO1 configuration</p> <p>0: 0~10V output</p> <p>1: 4~20mA output</p> <p>Tens digit: AO2 configuration</p> <p>0: 0~10V output</p> <p>1: 4~20mA output</p> <p>Hundreds digit: EAO1 configuration</p> <p>0: 0~10V output</p> | 1 | 0000 | × |

6 Function parameter schedule graph

| | | | | | |
|--------|---|---|---|-------|---|
| | | 1: 4~20mA output Thousands digit: EAO2 configuration 0: 0~10V output 1: 4~20mA output | | | |
| F00.22 | Y output terminal configuration | Units digit~ Hundreds digit: reserved Thousands digit: Y4 output configuration 0: Open collector output 1: DO output | 1 | 0000 | × |
| F00.23 | G/P type setup | 0: G type. 1: P type. Note: P type is only for V/F control | 1 | 0 | × |
| F00.24 | Motor control mode | 0: V/F control (object to torque control) 1: speed less sensor vector control 1 (compare to speed less sensor vector control 2, this control mode is more suitable for asynchronous motor≤160KW, support speed and vector control) 2: speed sensor vector control (support asynchronous motor speed and torque control) 3: speed less sensor vector control 2 (only support asynchronous motor speed control, this control mode is more suitable for motor ≥185KW) | 1 | 0 | × |
| F00.25 | Monitor parameter 2 selection | The same as parameter F00.01 | 1 | 4 | ○ |
| F00.26 | Busbar voltage adjustment coefficient | 0.900~1.100 | 1 | 1.000 | ○ |
| F00.27 | Parameters copying and Language selection | Units digit: Language(only valid for LCD keypad) 0: Chinese 1: English 2: Reserved Tens digit: parameter upload and download 0: Inaction 1: parameter upload 2: parameter download 1(without motor parameter) 3: parameter download 2(with motor parameter) | 1 | 00 | × |

F01—Basic Run Function Parameter Group

| Function Code | Name | Set Range | Min. Unit | Factory Default | Modification |
|---------------|--|---|-----------|-----------------|--------------|
| F01.00 | Main frequency input channel selection | 0: Operation keyboard digital setup 1: AI1 analog setup 2: AI2 analog setup 3: Terminal UP/DOWN adjusting setup 4: Communication provide(Communication address: 1E01). 5: EA11 analog setup. 6: EA12 analog setup 7: High speed pulse setup X8 terminal need choose the suitable function) 8: Terminal pulse setup(X8 terminal need choose the suitable function) 9: Terminal encoder setup(X1:X2 connect the encoder punctuation input) 10~14: Reserved | 1 | 0 | ○ |
| F01.01 | Main frequency | 0.00Hz~upper limit frequency | 0.01Hz | 50.00Hz | ○ |

| | | | | | |
|--------|--|--|--------|--------|---|
| | digital setup | | | | |
| F01.02 | Main frequency digital control | <p>Only when parameter F01.00=0:3:4 valid.</p> <p>Units digit: power down reserve setup 0:Main frequency power down reserve. 1:Main frequency power down no reserve.</p> <p>Tens digit: halt reserve setup 0:Halt main frequency hold 1:Halt main frequency recovery F01.01</p> <p>Hundreds digit: Set of communication presetting frequency dimension 0:Preset of absolute frequency mode(preset 5000 represent 50.00Hz). 1:Preset 10000 represent upper limit frequency (F01.11).</p> | 1 | 00 | ○ |
| F01.03 | Auxiliary frequency input channel select | <p>0: Operation keyboard digital setup 1: AI1 analog setup 2: AI2 analog setup 3:Terminal UP/DOWN adjusting setup 4:Communication provide(Communication address: 1E01). 5:EA11 analog setup. 6:EA12 analog setup 7:High speed pulse setup X8 terminal need choose the suitable function) 8:Terminal pulse setup(X8 terminal need choose the suitable function) 9:Terminal encoder setup(X1:X2 connect the encoder punctuation input) 10: Reserved 11: process PID Setting 12~20: Reserved</p> | 1 | 20 | ○ |
| F01.04 | Auxiliary frequency digital setup | 0.00Hz~upper limit frequency | 0.01Hz | 0.00Hz | ○ |
| F01.05 | Auxiliary frequency digital control | <p>Units digit: power down reserve setup 0:Auxiliary frequency power down reserve. 1:Auxiliary frequency power down no reserve.</p> <p>Tens digit: halt reserve setup 0:Halt auxiliary frequency hold. 1:Halt auxiliary frequency recovery parameter F01.04</p> | 1 | 11 | ○ |
| F01.06 | Main and auxiliary provide calculating setup | <p>0:Main frequency (complex frequency of current is main frequency). 1: Auxiliary frequency(complex frequency of current is auxiliary frequency.) 2: Plus(polarity oppose of complex and main frequency, complex frequency is zero). 3:Minus(polarity oppose of complex and auxiliary frequency, complex frequency is zero). 4:Multiplication(polarity opposed of main and auxiliary frequency: complex frequency is zero). 5:Max(the max frequency of main and auxiliary absolute value). 6:Min(the min frequency of main and auxiliary absolute value). 7:Selection no-zero value(auxiliary is not negative, main frequency prior; auxiliary is negative, complex frequency is zero). 8:main frequency×Auxiliary frequency×2/F01.11</p> | 1 | 0 | ○ |

6 Function parameter schedule graph

| | | | | | |
|--------|---|--|--------|--------------------|---|
| | | (polarity opposed of main and auxiliary frequency complex frequency is zero) | | | |
| F01.07 | Auxiliary frequency provide coefficient | 0.00~10.00 | 0.01 | 1.00 | ○ |
| F01.08 | Coefficient after complex of main and auxiliary frequency | 0.00~10.00 | 0.01 | 1.00 | ○ |
| F01.09 | Auxiliary frequency range selection | 0:Relative upper limit frequency. 1:Relative main frequency. | 1 | 0 | ○ |
| F01.10 | Auxiliary frequency source scope | 0.00~1.00 | 0.01 | 1.00 | ○ |
| F01.11 | upper limit frequency | Low limit frequency~600.00Hz | 0.01Hz | 50.00Hz | × |
| F01.12 | Low limit frequency | 0.00Hz~upper limit frequency | 0.01Hz | 0.40Hz | × |
| F01.13 | Low limit frequency run mode | 0:As low limit frequency run. 1:As setting frequency run. 2:As zero frequency run. 3:Sleep: PWM clocked at sleep mode. | 1 | 2 | × |
| F01.14 | Sleep run hysteresis frequency | 0.01Hz~upper limit frequency (This function can be used to finish the sleep mode function, realizing energy-saving operation process, and the hysteresis width can avoid inverter starting frequently in threshold) | 0.01Hz | 0.01Hz | ○ |
| F01.15 | Run command channel selection | 0:Operation keyboard run control. 1:Terminal run command control 2:Communication run command control. | 1 | 0 | ○ |
| F01.16 | Run direction setup | Units digit: Keyboard command for/rev setup(only valid to keyboard inching command) 0:Forward 1:Reverse Tens digit: for/rev forbid(suitable for all command channel, not include inching function) 0:For/rev available. 1:Reverse not available(imposing on reverse, stop as the halt mode). 2:Forward not available(imposing on forward, stop as the halt mode) Hundreds digit: Reverse running direction (only valid for keyboard and communication channel) 0:invalid 1: valid Thousands digit: Terminal multi-section speed acceleration and deceleration time control 0:Respectively, corresponding to acceleration and deceleration 1~15 1:Determined by F01.17 and F01.18 | 1 | 1000 | ○ |
| F01.17 | Acceleration time 1 | 1~60000(Acceleration time is interval accelerate from zero frequency to upper limit frequency) | 1 | Base on motor type | ○ |
| F01.18 | Deceleration time 1 | 1~60000(deceleration time is the interval decelerate from upper limit frequency to zero frequency.) | 1 | Base on motor type | ○ |

| | | | | | |
|--------|--|--|--------|--------|---|
| F01.19 | Acc/Dece time unit | 0: 0.01s 1: 0.1s 2: 1s | 1 | 1 | × |
| F01.20 | Acc/Dece mode selection | 0:Line acc/Dece mode. 1:S curve acc/Dece mode. | 1 | 0 | × |
| F01.21 | S curve acceleration initiation segment time | 10.0%~50.0% ((Acceleration/deceleration time) S curve deceleration start time+ S curve deceleration raise time ≤90%) | 0.1% | 20.0% | ○ |
| F01.22 | S curve acceleration segment time | 10.0%~70.0%(Acceleration/deceleration time) S curve acceleration start time+ S curve acceleration raise time ≤90%) | 0.1% | 60.0% | ○ |
| F01.23 | S curve deceleration initiation segment time | 10.0%~50.0%(Acceleration/deceleration time) S curve acceleration start time+ S curve acceleration raise time ≤90%) | 0.1% | 20.0% | ○ |
| F01.24 | S curve deceleration up segment time | 10.0%~70.0%(Acceleration/deceleration time) S curve acceleration start time+ S curve acceleration raise time ≤90%) | 0.1% | 60.0% | ○ |
| F01.25 | Keyboard jog run frequency | 0.00Hz~upper limit frequency | 0.01Hz | 5.00Hz | ○ |
| F01.26 | Terminal jog run frequency | 0.00Hz~upper limit frequency | 0.01Hz | 5.00Hz | ○ |
| F01.27 | Jog interval time | 0.0~100.0s | 0.1s | 0.0s | ○ |
| F01.28 | Jog acceleration time | 0.1~6000.0s | 0.1s | 20.0s | ○ |
| F01.29 | Jog deceleration time | 0.1~6000.0s | 0.1s | 20.0s | ○ |

F02—Start, stop, forward/reverse, brake function parameter group

| Function Code | Name | Set Range | Min. Unit | Factory Default | Modification |
|---------------|--|---|-----------|-----------------|--------------|
| F02.00 | Start running mode | 0: Start from starting frequency 1: First brake and then start from starting frequency 2: Start by revolving speed tracking | 1 | 0 | × |
| F02.01 | Starting delay time | 0.0~60.0s | 0.1s | 0.0s | × |
| F02.02 | Starting frequency | 0.0~10.00Hz | 0.01Hz | 0.00Hz | × |
| F02.03 | Starting frequency duration time | 0.0~60.0s | 0.1s | 0.0s | × |
| F02.04 | DC braking current when starting | 0.0~100.0% (G type inverter rated current) | 0.1% | 30.0% | × |
| F02.05 | DC braking time when starting | 0.0~30.0s | 0.1s | 0.0s | × |
| F02.06 | Speed track starting frequency selection | 0: Current setting frequency. 1: Running frequency before power down. 2:Speed track auxiliary starting frequency. | 1 | 2 | × |
| F02.07 | Speed track auxiliary starting frequency | 0.00Hz~upper limit frequency | 0.01Hz | 30.00Hz | × |
| F02.08 | Speed track starting waiting | 0.00~10.00s | 0.01s | 0.10s | × |

6 Function parameter schedule graph

| | | | | | |
|--------|---|---|--------|--------|---|
| | time | | | | |
| F02.09 | Speed track current control coefficient | 1~20 | 1 | 2 | × |
| F02.10 | Speed track searching speed time | 0.1~30.0 (V/F control unit is 1 second; SVC control unit is 0.1 second) | 0.1 | 4.0 | × |
| F02.11 | Stop mode | 0: Deceleration stop. 1: Free stop 2: Deceleration + DC braking stop. | 1 | 0 | ○ |
| F02.12 | Deceleration stop holding frequency | 0.00~upper limit frequency (This parameter is only valid for stop mode 0.) | 0.01Hz | 0.00Hz | × |
| F02.13 | Deceleration stop holding time | 0.00~10.00s | 0.01s | 0.00s | × |
| F02.14 | Stop DC braking starting frequency | 0.00~15.00Hz | 0.01Hz | 0.50Hz | × |
| F02.15 | stop DC braking waiting time | 0.00~30.00s | 0.01s | 0.00s | × |
| F02.16 | Stop DC braking current | 0.0~100.0% (G type inverter rated current) | 0.1% | 0.0% | × |
| F02.17 | Stop DC braking time | 0.0~30.0s | 0.1s | 0.0s | × |
| F02.18 | Stop auxiliary braking current | 0.0~100.0% (G type inverter rated current) | 0.1% | 0.0% | × |
| F02.19 | Stop auxiliary braking time | 0.0~100.0s | 0.1s | 0.0s | × |
| F02.20 | Forward/reverse dead zone time | 0.0~3600.0s | 0.1s | 0.0s | × |
| F02.21 | Forward/reverse switching mode | 0: Over zero switchover 1: Over starting frequency switchover | 1 | 0 | × |
| F02.22 | Energy consumption braking selection | 0:No energy consumption braking 1:Energy consumption braking 1(No braking while halting). 2: Energy consumption braking 2(Braking while halting). | 1 | 0 | ○ |
| F02.23 | Energy consumption braking voltage | 100.0~145.0% (rated busbar voltage) | 0.1% | 125.0% | ○ |
| F02.24 | Energy consumption braking use rate | 0.0~100.0% | 0.1% | 100.0% | ○ |
| F02.25 | Encryption time | 0~65535h | 1 | 0 | ○ |
| F02.26 | Over debugging coefficient | 95%~115% (only when F00.24=1 valid) | 1% | 100% | ○ |

F03—V/F control parameter group

| Function Code | Name | Set Range | Min. Unit | Factory Default | Modification |
|---------------|-------------------|---|-----------|--------------------|--------------|
| F03.00 | V/F curve set | 0: Constant torque curve 1: Degression torque curve 1 (2.0 power) 2: Degression torque curve 1 (1.7 power) 3: Degression torque curve 3 (1.2 power) 4: User self-defined setting V/F curve (Confirmed by F03.04~F03.11) 5:V/F Separation control (voltage channel is determined by F18.22) | 1 | 0 | × |
| F03.01 | Torque boost mode | 0: Manual boost. 1: Auto torque boost | 1 | 0 | ○ |
| F03.02 | Torque boost | 0.0~12.0% | 0.1% | Base on motor type | ○ |

| | | | | | |
|--------|------------------------------------|--|--------|---------|---|
| F03.03 | Torque boost cut-off frequency | 0.0~100.0% (motor rated frequency) | 0.1% | 100.0% | ○ |
| F03.04 | V/F frequency value 0 | 0.00~V/F frequency value 1 | 0.01Hz | 10.00Hz | × |
| F03.05 | V/F voltage value 0 | 0.00~V/F voltage value 1 | 0.01% | 20.00% | × |
| F03.06 | V/F frequency value 1 | V/F frequency value 0~V/F frequency value 2 | 0.01Hz | 20.00Hz | × |
| F03.07 | V/F voltage value 1 | V/F voltage value 0~V/F voltage value 2 | 0.01% | 40.00% | × |
| F03.08 | V/F frequency value 2 | V/F frequency value 1~V/F frequency value 3 | 0.01Hz | 25.00Hz | × |
| F03.09 | V/F voltage value 2 | V/F voltage value 1~V/F voltage value 3 | 0.01% | 50.00% | × |
| F03.10 | V/F frequency value 3 | V/F voltage value 2~upper limit frequency | 0.01Hz | 40.00Hz | × |
| F03.11 | V/F voltage value 3 | V/F voltage value 2~100.00%(motor rated voltage) | 0.01% | 80.00% | × |
| F03.12 | V/F oscillation suppression factor | 0~255 | 1 | 10 | ○ |

F04—Auxiliary running parameter group

| Function Code | Name | Set Range | Min. Unit | Factory Default | Modification |
|---------------|--|--|-----------|---------------------|--------------|
| F04.00 | Jump freq. 1 | 0.00Hz~upper limit frequency | 0.01Hz | 0.00Hz | × |
| F04.01 | Jump freq. 1 range | 0.00Hz~upper limit frequency | 0.01Hz | 0.00Hz | × |
| F04.02 | Jump freq. 2 | 0.00Hz~upper limit frequency | 0.01Hz | 0.00Hz | × |
| F04.03 | Jump freq. 2 range | 0.00Hz~upper limit frequency | 0.01Hz | 0.00Hz | × |
| F04.04 | Jump freq. 3 | 0.00Hz~upper limit frequency | 0.01Hz | 0.00Hz | × |
| F04.05 | Jump freq. 3 range | 0.00Hz~upper limit frequency | 0.01Hz | 0.00Hz | × |
| F04.06 | Slip freq. gain | 0.0~300.0% | 0.1% | 0.0% | × |
| F04.07 | Slip compensation limit | 0.0~250.0% | 0.1% | 100.0% | × |
| F04.08 | Slip compensation time constant | 0.1~25.0s | 0.1s | 2.0s | × |
| F04.09 | Carrier freq. | 0.5~16.0K | 0.1K | Based on motor type | ○ |
| F04.10 | PWM optimized adjustment | Units digit: Carrier freq. is adjusted automatically according to temperature 0: Banned. 1: Allowed. Tens digit: low speed carrier freq. limit mode 0: No limit. 1: Limit. Hundreds digit: carrier wave modulation system 0: 3 phase modulation. 1: 2 phase and 3 phase modulation. Thousands digit: Asynchronous modulation: synchronization mode (valid under V/F control) 0: Asynchronous modulation. 1: Synchronous modulation (under 85Hz: Asynchronous modulation). | 1 | 0010 | × |
| F04.11 | AVR function | 0: No action 1: Action all the time 2: No action only during deceleration | 1 | 2 | × |
| F04.12 | Reserved | | | | |
| F04.13 | Automatic energy-saving operation | 0: No action 1: Action | 1 | 0 | × |
| F04.14 | Acceleration time 2 and 1 switchover frequency | 0.00Hz~upper limit frequency | 0.01Hz | 0.00Hz | × |
| F04.15 | Deceleration time 2 and 1 | 0.00Hz~upper limit frequency | 0.01Hz | 0.00Hz | × |

6 Function parameter schedule graph

| | switchover frequency | | | | |
|--------|----------------------|---------|---|-----|---|
| F04.16 | Acceleration time 2 | 1~60000 | 1 | 200 | ○ |
| F04.17 | Deceleration time 2 | 1~60000 | 1 | 200 | ○ |
| F04.18 | Acceleration time 3 | 1~60000 | 1 | 200 | ○ |
| F04.19 | Deceleration time 3 | 1~60000 | 1 | 200 | ○ |
| F04.20 | Acceleration time 4 | 1~60000 | 1 | 200 | ○ |
| F04.21 | Deceleration time 4 | 1~60000 | 1 | 200 | ○ |
| F04.22 | Acceleration time 5 | 1~60000 | 1 | 200 | ○ |
| F04.23 | Deceleration time 5 | 1~60000 | 1 | 200 | ○ |
| F04.24 | Acceleration time 6 | 1~60000 | 1 | 200 | ○ |
| F04.25 | Deceleration time 6 | 1~60000 | 1 | 200 | ○ |
| F04.26 | Acceleration time 7 | 1~60000 | 1 | 200 | ○ |
| F04.27 | Deceleration time 7 | 1~60000 | 1 | 200 | ○ |
| F04.28 | Acceleration time 8 | 1~60000 | 1 | 200 | ○ |
| F04.29 | Deceleration time 8 | 1~60000 | 1 | 200 | ○ |
| F04.30 | Acceleration time 9 | 1~60000 | 1 | 200 | ○ |
| F04.31 | Deceleration time 9 | 1~60000 | 1 | 200 | ○ |
| F04.32 | Acceleration time 10 | 1~60000 | 1 | 200 | ○ |
| F04.33 | Deceleration time 10 | 1~60000 | 1 | 200 | ○ |
| F04.34 | Acceleration time 11 | 1~60000 | 1 | 200 | ○ |
| F04.35 | Deceleration time 11 | 1~60000 | 1 | 200 | ○ |
| F04.36 | Acceleration time 12 | 1~60000 | 1 | 200 | ○ |
| F04.37 | Deceleration time 12 | 1~60000 | 1 | 200 | ○ |
| F04.38 | Acceleration time 13 | 1~60000 | 1 | 200 | ○ |
| F04.39 | Deceleration time 13 | 1~60000 | 1 | 200 | ○ |
| F04.40 | Acceleration time 14 | 1~60000 | 1 | 200 | ○ |
| F04.41 | Deceleration time 14 | 1~60000 | 1 | 200 | ○ |
| F04.42 | Acceleration time 15 | 1~60000 | 1 | 200 | ○ |
| F04.43 | Deceleration time 15 | 1~60000 | 1 | 200 | ○ |

F05—Terminal correlative function parameter group

| Function Code | Name | Set Range | Min. Unit | Factory Default | Modification |
|---------------|-------------------------|--|-----------|-----------------|--------------|
| F05.00 | protocol selection | 0: Modbus protocol . 1: Reserved 2: Profibus protocol . (Extend effective) 3: CANlink protocol . (Extend effective) 4: CANopen protocol . (Extend effective) 5: Free protocol 1. (Can realize all the function parameter modification of EN500/EN600) 6: Free protocol 2. (Can realize part of the function parameter modification of EN500/EN600) | 1 | 0 | × |
| F05.01 | Baud rate configuration | Units digit: Free protocol and Modbus Baud rate selection 0: 300BPS 1: 600BPS 2: 1200BPS 3: 2400BPS 4: 4800BPS 5: 9600BPS | 1 | 005 | × |

| | | | | | |
|--------|--|---|------|------|---|
| | | 6: 19200BPS 7: 38400BPS 8: 57600BPS 9: 115200BPS Tens digit: Reserved Hundreds digit: CanLink and CANopen Baud rate selection 0: 20K 1: 50K 2: 100K 3: 125K 4: 250K 5: 500K 6: 1M | | | |
| F05.02 | Data format | Units digit: Free protocol and Modbus protocol data format 0: 1-8-1 format, no parity, RTU 1: 1-8-1 format, even parity, RTU 2: 1-8-1 format, odd parity, RTU 3: 1-7-1 format, no parity, ASCII 4: 1-7-1 format, even parity, ASCII 5: 1-7-1 format, odd parity, ASCII Tens digit: Profibus_DP protocol data format 0: PPO1 communication format 1: PPO2 communication format 2: PPO3 communication format 3: PPO5 communication format Hundreds digit: Modbus agreement or free protocol response selection 0: respond mainframe demand, and respond data package 1: respond mainframe demand without response (response when write parameter) 2: respond mainframe demand without response (without response when write parameter) Thousands digit: Communication Sets power down reserve setup 0: no reserve 1: reserve | 1 | 0000 | × |
| F05.03 | Local address | 0~247, this function code is used to identify inverter's address: among which 0 is broadcast address. When setting broadcast address: it can only receive and execute upper computer broadcast command: while cannot respond to upper computer. | 1 | 1 | × |
| F05.04 | Communication overtime checkout time | 0.0~1000.0s | 0.1s | 0.0s | ○ |
| F05.05 | Communication error checkout time | 0.0~1000.0s | 0.1s | 0.0s | ○ |
| F05.06 | Local response delay time | 0~200ms (Modbus effective) | 1ms | 2ms | ○ |
| F05.07 | Main & sub inverter communication frequency setting percentage | 0~500% | 1% | 100% | ○ |
| F05.08 | communication virtual input terminal enabled | 00~FFH Bit0 : CX1 virtual input terminal enabled 0: forbidden 1 : enabled | 1 | 00H | ○ |

6 Function parameter schedule graph

| | | | | | |
|--------|---|--|------|-------|---|
| | | Bit1: CX2 virtual input terminal enabled 0: forbidden 1: enabled Bit2: CX3 virtual input terminal enabled 0: forbidden 1: enabled Bit3: CX4 virtual input terminal enabled 0: forbidden 1: enabled Bit4: CX5 virtual input terminal enabled 0: forbidden 1: enabled Bit5: CX6 virtual input terminal enabled 0: forbidden 1: enabled Bit6: CX7 virtual input terminal enabled 0: forbidden 1: enabled Bit7: CX8 virtual input terminal enabled 0: forbidden 1: enabled | | | |
| F05.09 | Communication virtual input terminal joining node | 0: Independent node. 1: Terminal node. | 1 | 0 | ○ |
| F05.10 | Communication virtual terminal CX1 function | 0~90 | 1 | 0 | ○ |
| F05.11 | Communication virtual terminal CX2 function | 0~90 | 1 | 0 | ○ |
| F05.12 | Communication virtual terminal CX3 function | 0~90 | 1 | 0 | ○ |
| F05.13 | Communication virtual terminal CX4 function | 0~90 | 1 | 0 | ○ |
| F05.14 | Communication virtual terminal CX5 function | 0~90 | 1 | 0 | ○ |
| F05.15 | Communication virtual terminal CX6 function | 0~90 | 1 | 0 | ○ |
| F05.16 | Communication virtual terminal CX7 function | 0~90 | 1 | 0 | ○ |
| F05.17 | Communication virtual terminal CX8 function | 0~90 | 1 | 0 | ○ |
| F05.18 | Input mapping application parameter 1 | F00.00~F26.xx | 0.01 | 25.00 | ○ |
| F05.19 | Input mapping application parameter 2 | F00.00~F26.xx | 0.01 | 25.00 | ○ |
| F05.20 | Input mapping application parameter 3 | F00.00~F26.xx | 0.01 | 25.00 | ○ |
| F05.21 | Input mapping application parameter 4 | F00.00~F26.xx | 0.01 | 25.00 | ○ |
| F05.22 | Input mapping application parameter 5 | F00.00~F26.xx | 0.01 | 25.00 | ○ |
| F05.23 | Input mapping application parameter 6 | F00.00~F26.xx | 0.01 | 25.00 | ○ |
| F05.24 | Input mapping application parameter 7 | F00.00~F26.xx | 0.01 | 25.00 | ○ |
| F05.25 | Input mapping application parameter 8 | F00.00~F26.xx | 0.01 | 25.00 | ○ |
| F05.26 | Input mapping application | F00.00~F26.xx | 0.01 | 25.00 | ○ |

| | | | | | |
|--------|---|---|---------|-------|---|
| | parameter 9 | | | | |
| F05.27 | Input mapping application parameter 10 | F00.00~F26.xx | 0.01 | 25.00 | ○ |
| F05.28 | Setting frequency | Display current setting frequency | 0.01Hz | | ○ |
| F05.29 | Frequency after current acceleration / deceleration | Display the frequency after current acceleration / deceleration | 0.01Hz | | ○ |
| F05.30 | Synchronous frequency | Display the current synchronous frequency | 0.01Hz | | ○ |
| F05.31 | Output current | Display the current output current | 0.1A | | ○ |
| F05.32 | Output voltage | Display the current output voltage | 1V | | ○ |
| F05.33 | DC busbar voltage | Displays the current DC busbar voltage | 0.1V | | ○ |
| F05.34 | Load motor speed | Display the current load motor speed | 1 r/min | | ○ |
| F05.35 | Set torque | Display the current set torque(>37367, it is negative) | 0.1% | | ○ |
| F05.36 | Output torque | Display the current output torque (>32767, it is negative) | 0.1% | | ○ |
| F05.37 | Torque current | Display the current torque current | 0.1A | | ○ |
| F05.38 | Accumulated power-on time | Display the accumulated power-on time of the inverter | 1hour | | ○ |
| F05.39 | Accumulated running time | Display the accumulated running time of the inverter | 1 hour | | ○ |

F06—Setting curve parameter group

| Function Code | Name | Set Range | Min. Unit | Factory Default | Modification |
|---------------|--|--|-----------|-----------------|--------------|
| F06.00 | Setting curve selection | Units digit: A11 curve selection 0: curve 1 1: curve 2 2: curve 3 Tens digit: A12 curve selection: The same as Units digit Hundred digit: rapid pulse curve selection: The same as Units digit Thousands digit: pulse width setting curve selection: The same as Units digit | 1 | 0000 | ○ |
| F06.01 | Curve 1 min. setting | 0.0%~curve 1 inflexion setting | 0.1% | 0.0% | ○ |
| F06.02 | Corresponding physical quantity of curve 1 min. setting | 0.0~100.0% | 0.1% | 0.0% | ○ |
| F06.03 | Curve 1 inflexion setting | Curve 1 min. setting ~ curve 1 Max. setting | 0.1% | 50.0% | ○ |
| F06.04 | Corresponding physical quantity of curve 1 inflexion setting | 0.0~100.0% | 0.1% | 50.0% | ○ |
| F06.05 | Curve 1 Max. setting | Curve 1 inflexion setting ~ 100.0%, 100.0% is corresponding to 5V Input AD terminal | 0.1% | 100.0% | ○ |
| F06.06 | Corresponding physical quantity of curve 1 Max. setting | 0.0~100.0% | 0.1% | 100.0% | ○ |
| F06.07 | Curve 2 min. setting | 0.0%~curve 2 inflexion setting | 0.1% | 0.0% | ○ |
| F06.08 | Corresponding physical quantity of curve 2 min. setting | 0.0~100.0% | 0.1% | 0.0% | ○ |
| F06.09 | Curve 2 inflexion setting | Curve 2 min. setting ~ curve 2 Max. setting | 0.1% | 50.0% | ○ |
| F06.10 | Corresponding physical quantity of curve 2 | 0.0~100.0% | 0.1% | 50.0% | ○ |

6 Function parameter schedule graph

| | | | | | |
|--------|--|--|------|--------|---|
| | inflexion setting | | | | |
| F06.11 | Curve 2 Max. setting | Curve 2 inflexion setting~100.0% | 0.1% | 100.0% | ○ |
| F06.12 | Corresponding physical quantity of curve 2 Max. setting | 0.0~100.0% | 0.1% | 100.0% | ○ |
| F06.13 | Curve 3 min. setting | 0.0%~curve 3 inflexion 1 setting | 0.1% | 0.0% | ○ |
| F06.14 | Corresponding physical quantity of curve 3 min. setting | 0.0~100.0% | 0.1% | 0.0% | ○ |
| F06.15 | Curve 3 inflexion 1 setting | Curve 3 min. setting ~ curve 3 inflexion 2 setting | 0.1% | 30.0% | ○ |
| F06.16 | Corresponding physical quantity of curve 3 inflexion 1 setting | 0.0~100.0% | 0.1% | 30.0% | ○ |
| F06.17 | Curve 3 inflexion 2 setting | Curve 3 inflexion 1 setting ~ curve 3 Max. setting | 0.1% | 60.0% | ○ |
| F06.18 | Corresponding physical quantity of curve 3 inflexion 2 setting | 0.0~100.0% | 0.1% | 60.0% | ○ |
| F06.19 | Curve 3 Max. setting | Curve 3 inflexion 1 setting~100.0% | 0.1% | 100.0% | ○ |
| F06.20 | Corresponding physical quantity of curve 3 Max. setting | 0.0~100.0% | 0.1% | 100.0% | ○ |
| F06.21 | Curve lower than min. input corresponding selection | Units digit: curve 1 setting 0: Corresponds to min. setting corresponding physical quantity. 1: 0.0% of the corresponding physical quantity. Tens digit: curve 2 setting Same as units digit. Hundreds digit: curve 3 setting Same as units digit. Thousands digit: extended curve 1 Same as units digit. Ten thousands digit: extended curve 2 Same as units digit. | 1 | 11111 | ○ |

F07—Analog , Pulse input function parameter group

| Function Code | Name | Set Range | Min. Unit | Factory Default | Modification |
|---------------|------------------------------|---|-----------|-----------------|--------------|
| F07.00 | A11 input filter time | 0.000~9.999s | 0.001s | 0.050s | × |
| F07.01 | A11 setting gain | 0.000~9.999 | 0.001 | 1.006 | ○ |
| F07.02 | A11 setting bias | 0.0~100.0% | 0.1% | 0.5% | ○ |
| F07.03 | A12 input filter time | 0.000~9.999s | 0.001 | 0.050s | × |
| F07.04 | A12 setting gain | 0.000~9.999 | 0.001 | 1.003 | ○ |
| F07.05 | A12 setting bias | 0.0~100.0% | 0.1% | 0.1% | ○ |
| F07.06 | Analog setting bias polarity | Units digit: A11 setting bias polarity 0: Positive polarity. 1: Negative polarity. Tens digit: A12 setting bias polarity 0: Positive polarity. 1: Negative polarity. | 1 | 01 | ○ |
| F07.07 | Pulse input filter time | 0.000~9.999s | 0.001 | 0.000s | × |
| F07.08 | Pulse input gain | 0.000~9.999 | 0.001 | 1.000 | ○ |
| F07.09 | Pulse input Max. | 0.01~50.00KHz | 0.01KHz | 10.00KHz | ○ |

| | | | | | |
|--------|--|---|--------|---------|---|
| | frequency | | | | |
| F07.10 | Pulse width input filter time | 0.000~9.999s | 0.001s | 0.000s | × |
| F07.11 | Pulse width input gain | 0.000~9.999 | 0.001 | 1.000 | ○ |
| F07.12 | Pulse width input logic setting. | 0:positive logic 1:negative logic | 1 | 0 | ○ |
| F07.13 | Max pulse input width | 0.1~999.9ms | 0.1ms | 100.0ms | ○ |
| F07.14 | Analog input disconnection detection threshold | 0.0%~100.0% | 0.1% | 10.0% | ○ |
| F07.15 | Analog input disconnection detection time | 0.0~500.0s | 0.1s | 3.0s | ○ |
| F07.16 | Analog disconnection protection option | units digit: disconnection detection channel choice 0: invalid 1: AI1 2: AI2 Tens digit: Disconnection protection way 0: Stop according to stop mode 1: Fault, free stop 2: continue operation | 1 | 10 | ○ |
| F07.17 | Reserved | | | | |

F08—On-off input function parameter group

| Function Code | Name | Set Range | Min. Unit | Factory Default | Modification |
|---------------|--|---|-----------|-----------------|--------------|
| F08.00 | Input terminal positive and negative logic setting | 0000~FFFF (include extend input terminal) | 1 | 0000 | ○ |
| F08.01 | Input terminal filter time | 0.000~1.000s (suitable for extend input terminal) | 0.001s | 0.010s | ○ |
| F08.02 | X1 Input terminal closed time | 0.00~99.99s | 0.01s | 0.00s | ○ |
| F08.03 | X1 Input terminal opened time | 0.00~99.99s | 0.01s | 0.00s | ○ |
| F08.04 | X2 Input terminal closed time | 0.00~99.99s | 0.01s | 0.00s | ○ |
| F08.05 | X2 Input terminal opened time | 0.00~99.99s | 0.01s | 0.00s | ○ |
| F08.06 | X3 Input terminal closed time | 0.00~99.99s | 0.01s | 0.00s | ○ |
| F08.07 | X3 Input terminal opened time | 0.00~99.99s | 0.01s | 0.00s | ○ |
| F08.08 | X4 Input terminal closed time | 0.00~99.99s | 0.01s | 0.00s | ○ |
| F08.09 | X4 Input terminal opened time | 0.00~99.99s | 0.01s | 0.00s | ○ |
| F08.10 | X5 Input terminal closed time | 0.00~99.99s | 0.01s | 0.00s | ○ |
| F08.11 | X5 Input terminal opened time | 0.00~99.99s | 0.01s | 0.00s | ○ |
| F08.12 | X6 Input terminal closed time | 0.00~99.99s | 0.01s | 0.00s | ○ |
| F08.13 | X6 Input terminal | 0.00~99.99s | 0.01s | 0.00s | ○ |

6 Function parameter schedule graph

| | | | | | |
|--------|--------------------------------------|--|-------|-------|---|
| | opened time | | | | |
| F08.14 | X7 Input terminal closed time | 0.00~99.99s | 0.01s | 0.00s | ○ |
| F08.15 | X7 Input terminal opened time | 0.00~99.99s | 0.01s | 0.00s | ○ |
| F08.16 | X8 Input terminal closed time | 0.00~99.99s | 0.01s | 0.00s | ○ |
| F08.17 | X8 Input terminal opened time | 0.00~99.99s | 0.01s | 0.00s | ○ |
| F08.18 | Input terminal X1 function selection | 0: Leave control terminal unused 1: Forward running FWD terminal 2: Reverse running REV terminal 3: External forward jogging control 4: External reverse jogging control 5: Multi-step speed control terminal 1 6: Multi-step speed control terminal 2 7: Multi-step speed control terminal 3 8: Multi-step speed control terminal 4 9: Acceleration/deceleration time selection terminal 1 10: Acceleration/deceleration time selection terminal 2 11: Acceleration/deceleration time selection terminal 3 12: Acceleration/deceleration time selection terminal 4 13: Main and auxiliary frequency operational rule selection terminal 1 14: Main and auxiliary frequency operational rule selection terminal 2 15: Main and auxiliary frequency operational rule selection terminal 3 16: Frequency ascending command (UP) 17: Frequency descending command (DOWN) 18: Frequency ascending/descending frequency resetting 19: Multi-step closed loop terminal 1 20: Multi-step closed loop terminal 2 21: Multi-step closed loop terminal 3 22: External equipment failure input 23: External interruption input 24: External resetting input 25: Free stop input 26: External stop instruction—Stop according to the stop mode 27: stop DC braking input command DB 28: inverter running prohibited—Stop according to the stop mode 29: Acceleration/deceleration prohibited command 30: Three-wire running control 31: Process PID invalid 32: Process PID stop 33: Process PID integral holding 34: Process PID integral resetting 35: Process PID function negation(Closed loop adjustment feature negation) 36: simple PLC invalid | 1 | 1 | × |

| | | | | | |
|--------|--------------------------------------|--|---|---|---|
| | | 37: simple PLC halted 38: simple PLC stop state resetting 39: main frequency switchover to digit (keypad) 40: main frequency switchover to AI1 41: main frequency switchover to AI2 42: main frequency switchover to EAI1 43: main frequency switchover to EAI2 44: main frequency setting channel selection terminal 1 45: main frequency setting channel selection terminal 2 46: main frequency setting channel selection terminal 3 47: main frequency setting channel selection terminal 4 48: Auxiliary frequency reset 49: Command switchover to panel 50: Command switchover to terminal 51: Command switchover to communication 52: Running command Channel selection terminal 1 53: Running command Channel selection terminal 2 54: Forward prohibited command (Stop according to the stop mode: invalid for jogging command) 55: Reverse prohibited command (Stop according to the stop mode: invalid for jogging command) 56: Swinging frequency input 57: Resetting state of swinging frequency 58: Interior counter reset end 59: Interior counter input end 60: Internal timer resetting 61: Internal timer triggering 62: Length count input 63: Length reset 64: Reset this operation time 65: speed/torque control switching 66: Point positioning enabled terminal (F00.24=2 valid). 67: Zero-speed servo enabled terminal (F00.24=2 valid). 68: Motor position reset terminal (F00.24=2 valid). 69: Recovery point positioning terminal (F00.24=2 valid). 70~90: Reserved 91: Pulse frequency input (X8 VALID) 92: Pulse width PWM INPUT (X8 VALID) 93~96: Reserved | | | |
| F08.19 | Input terminal X2 function selection | Same as above | 1 | 2 | × |
| F08.20 | Input terminal X3 function selection | Same as above | 1 | 0 | × |
| F08.21 | Input terminal X4 function selection | Same as above | 1 | 0 | × |
| F08.22 | Input terminal X5 function selection | Same as above | 1 | 0 | × |
| F08.23 | Input terminal X6 | Same as above | 1 | 0 | × |

6 Function parameter schedule graph

| | | | | | |
|--------|---------------------------------------|--|--------|--------|---|
| | function selection | | | | |
| F08.24 | Input terminal X7 function selection | Same as above | 1 | 0 | × |
| F08.25 | Input terminal X8 function selection | Same as above | 1 | 0 | × |
| F08.26 | FWD/REV operating mode selection | 0: Two-wire control mode 1 1: Two-wire control mode 2 2: Two-wire control mode 3 (monopulse control mode) 3: Three-wire control mode 1 4: Three-wire control mode 2 | 1 | 0 | × |
| F08.27 | Set internal count value to setting | 0~65535 | 1 | 0 | ○ |
| F08.28 | Specify internal count to setting | 0~65535 | 1 | 0 | ○ |
| F08.29 | Internal timer timing setting | 0.1~6000.0s | 0.1s | 60.0s | ○ |
| F08.30 | Terminal pulse encoder frequency rate | 0.01~10.00Hz (only be effective by given X1:X2 encoder) | 0.01Hz | 1.00Hz | ○ |
| F08.31 | Special function selection | Units digit: jogging priority level selection 0: the highest priority level 1: the lowest priority level Tens digit: keypad adjustment of display setting (under speed control mode) 0: display setting frequency 1: display setting rotation speed | 1 | 00 | ○ |

F09—On-off ,analog output function parameter group

| Function Code | Name | Set Range | Min. Unit | Factory Default | Modification |
|---------------|--|---|-----------|-----------------|--------------|
| F09.00 | Open collector output terminal Y1 output setup | 0:terminal unused 1:operation(RUN) 2:CW run 3:CCW run 4:DC brake 5:run prepare finish(busbar voltage normal, fault free, no run forbid, receipt of run command's status) 6:stop command indication 7:no current arrived 8:overcurrent arrived 9:current1 arrived 10:current2 arrived 11:no frequency output 12:frequency arrival signal(FAR) 13:frequency level detect signal 1(FDT1) 14:frequency level detect signal 2(FDT2) 15:output frequency arrival upper limit(FHL) 16:output frequency arrival low limit(FLL) 17:frequency 1 arrival output 18:frequency 2 arrival output 19:overload pre-alarm signal(OL) 20:undervoltage lockout stop (LU) 21:external fault stop(EXT) 22:fault 23:alarm 24: simple PLC operation 25:simple PLC section operation finish 26:simple PLC circle operation finish 27:simple PLC operation stop 28:traverse frequency high and low limit | 1 | 0 | × |

| | | | | | |
|--------|--|--|--------|---------|---|
| | | 29:setup length arrival 30:internal counter final value arrival 31:internal counter designated value arrival 32:internal timer arrival--output 0.5s valid signal on arrival 33:operation stop time finish 34:operation arrival time finish 35:setup run time arrival 36:setup power on time arrival 37:1 st pump variable frequency 38:1 st pump power frequency 39:2 nd pump variable frequency 40:2 nd pump power frequency 41:communication provision 42: torque control speed limiting 43: Torque arriving output 44: Positioning completion 45: The brake logic 1(brake in the process of switching forward and reverse) 46: The brake logic 2(not brake in the process of switching Forward and reverse) 47: Frequency inverter running 1(not jog running) 48: Analog input disconnection signal output 49: X1 terminal closed valid 50: X2 terminal closed valid 49-60: Reserved | | | |
| F09.01 | Open collector output terminal Y2 output setup | Same as above | 1 | 0 | × |
| F09.02 | Open collector output terminal Y3 output setup | Same as above | 1 | 0 | × |
| F09.03 | Open collector output terminal Y4 output setup | Same as above | 1 | 0 | × |
| F09.04 | Programmable relay output setting | Same as above | 1 | 22 | × |
| F09.05 | Detection amplitude of Frequency arrival(FAR) | 0.00~50.00Hz | 0.01Hz | 5.00Hz | ○ |
| F09.06 | FDT1(frequency level)level | 0.00Hz~upper limit frequency | 0.01Hz | 10.00Hz | ○ |
| F09.07 | FDT1 lag | 0.00~50.00Hz | 0.01Hz | 1.00Hz | ○ |
| F09.08 | FDT2(frequency level)level | 0.00Hz~upper limit frequency | 0.01Hz | 10.00Hz | ○ |
| F09.09 | FDT2 lag | 0.00~50.00Hz | 0.01Hz | 1.00Hz | ○ |
| F09.10 | Zero frequency signal detection value | 0.00Hz~upper limit frequency | 0.01Hz | 0.40Hz | ○ |
| F09.11 | Zero frequency backlash | 0.00Hz~upper limit frequency | 0.01Hz | 0.10Hz | ○ |
| F09.12 | Zero-current detection amplitude | 0.0~50.0% | 0.1% | 0.0% | ○ |
| F09.13 | Zero-current detection time | 0.00~60.00s | 0.01s | 0.1s | ○ |
| F09.14 | Over-current detection value | 0.0~250.0% | 0.1% | 160.0% | ○ |
| F09.15 | Over-current detection time | 0.00~60.00s | 0.01s | 0.00s | ○ |
| F09.16 | Current 1 arrival detection value | 0.0~250.0% | 0.1% | 100.0% | ○ |
| F09.17 | Current 1 width | 0.0~100.0% | 0.1% | 0.0% | ○ |

6 Function parameter schedule graph

| | | | | | |
|--------|--|---|--------|---------|---|
| F09.18 | Current 2 arriving the detection value | 0.0~250.0% | 0.1% | 100.0% | ○ |
| F09.19 | Current 2 width | 0.0~100.0% | 0.1% | 0.0% | ○ |
| F09.20 | Frequency 1 arriving the detection value | 0.00Hz~upper limit frequency | 0.01Hz | 50.00Hz | ○ |
| F09.21 | Frequency 1 arriving the detection width | 0.00Hz~upper limit frequency | 0.01Hz | 0.00Hz | ○ |
| F09.22 | Frequency 2 arriving the detection value | 0.00Hz~upper limit frequency | 0.01Hz | 50.00Hz | ○ |
| F09.23 | Frequency 2 arriving the detection width | 0.00Hz~upper limit frequency | 0.01Hz | 0.00Hz | ○ |
| F09.24 | positive and negative logic setup of Output terminal | 0000~FFFF (extension valid) | 1 | 0000 | ○ |
| F09.25 | Y1 output closed delay time | 0.000~50.000s | 0.001s | 0.000s | ○ |
| F09.26 | Y1 output disconnected delay time | 0.000~50.000s | 0.001s | 0.000s | ○ |
| F09.27 | Y2 output closed delay time | 0.000~50.000s | 0.001s | 0.000s | ○ |
| F09.28 | Y2 output disconnected delay time | 0.000~50.000s | 0.001s | 0.000s | ○ |
| F09.29 | Y3 output closed delay time | 0.000~50.000s | 0.001s | 0.000s | ○ |
| F09.30 | Y3 output disconnected delay time | 0.000~50.000s | 0.001s | 0.000s | ○ |
| F09.31 | Y4 output closed delay time | 0.000~50.000s | 0.001s | 0.000s | ○ |
| F09.32 | Y4 output disconnected delay time | 0.000~50.000s | 0.001s | 0.000s | ○ |
| F09.33 | Relay output closed delay time | 0.000~50.000s | 0.001s | 0.000s | ○ |
| F09.34 | Relay output disconnected delay time | 0.000~50.000s | 0.001s | 0.000s | ○ |
| F09.35 | Analog output(AO1) selection | 0:output frequency before slip compensation (0.00Hz~upper limit frequency) 1:output frequency after slip Compensation (0.00Hz~upper limit frequency) 2:Setup frequency(0.00Hz~upper limit frequency) 3:main setting frequency(0.00Hz~upper limit frequency) 4:auxiliary setting frequency(0.00Hz~upper limit frequency) 5:output current 1(0~2×inverter rated current) 6:output current 2(0~3×motor rated current) 7:output voltage(0~1.2×load motor rated voltage) 8:busbar voltage(0~1.5×rated busbar voltage) 9:motor speed(0~3 rated speed) 10:PID provision(0.00~10.00V) 11:PID feedback(0.00~10.00V) 12:A11(0.00~10.00V or 4~20mA) 13:A12(-10.00~10.00V or 4~20mA) 14:communication provision 15: motor rotor revolving speed (0.00Hz~upper limit frequency) | 1 | 0 | ○ |

| | | | | | |
|--------|--------------------------------------|---|--------|---------|---|
| | | 16: present setting torque (0~2 times rated torque) 17: present output torque (0~2 times rated torque) 18: present torque current (0~2 times motor rated current) 19: present flux current (0~1 times motor rated flux current) 20~25: Reserved | | | |
| F09.36 | Analog output(AO2) selection | Same as above | 1 | 0 | ○ |
| F09.37 | DO function selection(with Y4 reuse) | Same as above | 1 | 0 | ○ |
| F09.38 | Reserved | | | | |
| F09.39 | Analog output(AO1) filter time | 0.0~20.0s | 0.1s | 0.0s | ○ |
| F09.40 | Analog output(AO1) gain | 0.00~2.00 | 0.01 | 1.00 | ○ |
| F09.41 | Analog output(AO1) bias | 0.0~100.0% | 0.1% | 0.0% | ○ |
| F09.42 | Analog output(AO2) filter time | 0.0~20.0s | 0.1s | 0.0s | ○ |
| F09.43 | Analog output(AO2) gain | 0.00~2.00 | 0.01 | 1.00 | ○ |
| F09.44 | Analog output(AO2) bias | 0.0~100.0% (AO2 output terminal with Y3 reuse) | 0.1% | 0.0% | ○ |
| F09.45 | DO filter time | 0.0~20.0s | 0.1s | 0.0s | ○ |
| F09.46 | DO output gain | 0.00~2.00 | 0.01 | 1.00 | ○ |
| F09.47 | DO maximum pulse output frequency | 0.1~20.0KHz | 0.1KHz | 10.0KHz | ○ |
| F09.48 | Torque reaches to the detection time | 0.02~200.00s | 0.01s | 1.00s | ○ |
| F09.49 | Reserved | | | | |
| F09.50 | Reserved | | | | |

F10—Simple PLC/Multi-speed Function Parameter Group

| Function Code | Name | Set Range | Min. Unit | Factory Default | Modification |
|---------------|----------------------------|---|-----------|-----------------|--------------|
| F10.00 | Simple PLC operate setting | Units digit: run mode selection 0:inaction 1:stop after single cycle 2:final value keep after single cycle 3:continuous cycle Tens digit: interrupt run restart mode selection 0:restart from first phase 1:continuous run from phase frequency at interruption 2:continuous run from run frequency at interruption Hundreds digit: PLC run time unit 0:second 1:minute Thousands digit: power-down memory selection 0:no memory | 1 | 0000 | × |

6 Function parameter schedule graph

| | | | | | |
|--------|----------------------|---|-----|------|---|
| | | 1:phase of reserve power down, frequency power down recording PLC run status: contain power down phase, run frequency, time have run. | | | |
| F10.01 | Step 1 setting | 000H~E22H Units digit: frequency setup 0: Multi-section frequency i (i=1~15) 1:frequency determined by complex frequency of main and auxiliary 2: Reserved Tens digit: The selection of running direction for PLC and multi-speed. 0:forward 1:reversal 2:determine by run command Hundreds digit: ACC/DEC time selection 0: ACC/DEC time 1 1: ACC/DEC time 2 2: ACC/DEC time 3 3: ACC/DEC time 4 4: ACC/DEC time 5 5: ACC/DEC time 6 6: ACC/DEC time 7 7: ACC/DEC time 8 8: ACC/DEC time 9 9: ACC/DEC time 10 A: ACC/DEC time 11 B: ACC/DEC time 12 C: ACC/DEC time 13 D: ACC/DEC time 14 E: ACC/DEC time 15 | 1 | 020 | ○ |
| F10.02 | Step 2 setting | 000H~E22H | 1 | 020 | ○ |
| F10.03 | Step 3 setting | 000H~E22H | 1 | 020 | ○ |
| F10.04 | Step 4 setting | 000H~E22H | 1 | 020 | ○ |
| F10.05 | Step 5 setting | 000H~E22H | 1 | 020 | ○ |
| F10.06 | Step 6 setting | 000H~E22H | 1 | 020 | ○ |
| F10.07 | Step 7 setting | 000H~E22H | 1 | 020 | ○ |
| F10.08 | Step 8 setting | 000H~E22H | 1 | 020 | ○ |
| F10.09 | Step 9 setting | 000H~E22H | 1 | 020 | ○ |
| F10.10 | Step 10 setting | 000H~E22H | 1 | 020 | ○ |
| F10.11 | Step 11 setting | 000H~E22H | 1 | 020 | ○ |
| F10.12 | Step 12 setting | 000H~E22H | 1 | 020 | ○ |
| F10.13 | Step 13 setting | 000H~E22H | 1 | 020 | ○ |
| F10.14 | Step 14 setting | 000H~E22H | 1 | 020 | ○ |
| F10.15 | Step 15 setting | 000H~E22H | 1 | 020 | ○ |
| F10.16 | Step 1 running time | 0~6000.0 | 0.1 | 10.0 | ○ |
| F10.17 | Step 2 running time | 0~6000.0 | 0.1 | 10.0 | ○ |
| F10.18 | Step 3 running time | 0~6000.0 | 0.1 | 10.0 | ○ |
| F10.19 | Step 4 running time | 0~6000.0 | 0.1 | 10.0 | ○ |
| F10.20 | Step 5 running time | 0~6000.0 | 0.1 | 10.0 | ○ |
| F10.21 | Step 6 running time | 0~6000.0 | 0.1 | 10.0 | ○ |
| F10.22 | Step 7 running time | 0~6000.0 | 0.1 | 10.0 | ○ |
| F10.23 | Step 8 running time | 0~6000.0 | 0.1 | 10.0 | ○ |
| F10.24 | Step 9 running time | 0~6000.0 | 0.1 | 10.0 | ○ |
| F10.25 | Step 10 running time | 0~6000.0 | 0.1 | 10.0 | ○ |
| F10.26 | Step 11 running time | 0~6000.0 | 0.1 | 10.0 | ○ |
| F10.27 | Step 12 running time | 0~6000.0 | 0.1 | 10.0 | ○ |

| | | | | | |
|--------|----------------------|------------------------------|--------|---------|---|
| F10.28 | Step 13 running time | 0~6000.0 | 0.1 | 10.0 | ○ |
| F10.29 | Step 14 running time | 0~6000.0 | 0.1 | 10.0 | ○ |
| F10.30 | Step 15 running time | 0~6000.0 | 0.1 | 10.0 | ○ |
| F10.31 | Multi- frequency 1 | 0.00Hz~upper limit frequency | 0.01Hz | 5.00Hz | ○ |
| F10.32 | Multi- frequency 2 | 0.00Hz~upper limit frequency | 0.01Hz | 10.00Hz | ○ |
| F10.33 | Multi- frequency 3 | 0.00Hz~upper limit frequency | 0.01Hz | 20.00Hz | ○ |
| F10.34 | Multi- frequency 4 | 0.00Hz~upper limit frequency | 0.01Hz | 30.00Hz | ○ |
| F10.35 | Multi- frequency 5 | 0.00Hz~upper limit frequency | 0.01Hz | 40.00Hz | ○ |
| F10.36 | Multi- frequency 6 | 0.00Hz~upper limit frequency | 0.01Hz | 45.00Hz | ○ |
| F10.37 | Multi- frequency 7 | 0.00Hz~upper limit frequency | 0.01Hz | 50.00Hz | ○ |
| F10.38 | Multi- frequency 8 | 0.00Hz~upper limit frequency | 0.01Hz | 5.00Hz | ○ |
| F10.39 | Multi- frequency 9 | 0.00Hz~upper limit frequency | 0.01Hz | 10.00Hz | ○ |
| F10.40 | Multi- frequency 10 | 0.00Hz~upper limit frequency | 0.01Hz | 20.00Hz | ○ |
| F10.41 | Multi- frequency 11 | 0.00Hz~upper limit frequency | 0.01Hz | 30.00Hz | ○ |
| F10.42 | Multi- frequency 12 | 0.00Hz~upper limit frequency | 0.01Hz | 40.00Hz | ○ |
| F10.43 | Multi- frequency 13 | 0.00Hz~upper limit frequency | 0.01Hz | 45.00Hz | ○ |
| F10.44 | Multi- frequency 14 | 0.00Hz~upper limit frequency | 0.01Hz | 50.00Hz | ○ |
| F10.45 | Multi- frequency 15 | 0.00Hz~upper limit frequency | 0.01Hz | 50.00Hz | ○ |

| F11—Close loop PID run function parameter group | | | | | |
|---|---------------------------------------|---|-----------|-----------------|--------------|
| Function Code | Name | Set Range | Min. Unit | Factory Default | Modification |
| F11.00 | Closed-loop running control selection | 0:PID close loop run control invalid 1:PID close loop run control valid | 1 | 0 | × |
| F11.01 | Provision channel selection | 0:Digital provision 1:A11 analog provision 2:A12 analog provision 3:EAI1 analog provision 4:EAI2 analog provision 5: Pulse provision 6: Communication provision(Communication address: 1D00). 7: Reserved | 1 | 0 | ○ |
| F11.02 | Feedback channel selection | 0: A11 analog input 1: A12 analog input 2: EAI1 analog input (Extend effective) 3: EAI2 analog input (Extend effective) 4: A11+A12 5: A11-A12 6: Min {A11, A12} 7: Max {A11, A12} 8: Pulse input 9:Communication feedback (address is 1DOC, 4000 stands for 10.00V) | 1 | 0 | ○ |
| F11.03 | Provision channel filtering time | 0.00~50.00s | 0.01s | 0.20s | × |
| F11.04 | Feedback channel filtering time | 0.00~50.00s | 0.01s | 0.10s | × |
| F11.05 | PID output filtering time | 0.00~50.00s | 0.01s | 0.10s | ○ |
| F11.06 | Provision digital setting | 0.00~10.00V | 0.01V | 1.00V | ○ |
| F11.07 | Proportion gain Kp | 0.000~6.5535 | 0.0001 | 0.0500 | ○ |
| F11.08 | Integral gain Ki | 0.000~6.5535 | 0.0001 | 0.0500 | ○ |
| F11.09 | Differential gain Kd | 0.000~9.999 | 0.001 | 0.000 | ○ |
| F11.10 | Sample cycle T | 0.01~1.00s | 0.01s | 0.10s | ○ |
| F11.11 | Deviation limit | 0.0~20.0% correspond to provide value | 0.1% | 2.0% | ○ |

6 Function parameter schedule graph

| | | | | | |
|--------|--|---|--------|---------|---|
| F11.12 | PID differential amplitude limit | percentage 0.00~100.00% | 0.01% | 0.10% | ○ |
| F11.13 | Closed-loop regulation characteristic | 0:action 1:reaction | 1 | 0 | ○ |
| F11.14 | Feedback channel Positive-Negative characteristic | 0:positive characteristic 1:negative characteristic | 1 | 0 | ○ |
| F11.15 | PID regulation upper limit frequency | 0.00Hz~upper limit frequency | 0.01Hz | 50.00Hz | ○ |
| F11.16 | PID regulation lower limit frequency | 0.00Hz~upper limit frequency | 0.01Hz | 0.00Hz | ○ |
| F11.17 | Integral regulation selection | 0:when integral arrival separate PID threshold value, stop integral adjusting 1:when integral arrival separate PID threshold value, continue threshold value adjusting | 1 | 0 | ○ |
| F11.18 | PID threshold of the integral separation | 0.0~100.0% | 0.1% | 100.0% | ○ |
| F11.19 | Preset closed-loop frequency | 0.00Hz~upper limit frequency | 0.01Hz | 0.00Hz | ○ |
| F11.20 | Holding time of preset closed-loop frequency | 0.0~6000.0s | 0.1s | 0.0s | ○ |
| F11.21 | Closed-loop output reversion selection | 0:close-loop output minus, low limit frequency run. 1:close-loop output minus, reverse run (effect by run direction setting) 2:determined by running demand | 1 | 2 | ○ |
| F11.22 | Closed-loop output Reversion frequency upper limit | 0.00Hz~upper limit frequency | 0.01Hz | 50.00Hz | ○ |
| F11.23 | Multiple closed-loop provision 1 | 0.00~10.00V | 0.01V | 0.00V | ○ |
| F11.24 | Multiple closed-loop provision 2 | 0.00~10.00V | 0.01V | 0.00V | ○ |
| F11.25 | Multiple closed-loop provision 3 | 0.00~10.00V | 0.01V | 0.00V | ○ |
| F11.26 | Multiple closed-loop provision 4 | 0.00~10.00V | 0.01V | 0.00V | ○ |
| F11.27 | Multiple closed-loop provision 5 | 0.00~10.00V | 0.01V | 0.00V | ○ |
| F11.28 | Multiple closed-loop provision 6 | 0.00~10.00V | 0.01V | 0.00V | ○ |
| F11.29 | Multiple closed-loop provision 7 | 0.00~10.00V | 0.01V | 0.00V | ○ |

F12—Constant Pressure Water Supply Function Parameter Group

| Function code | Name | Set range | Min. unit | Factory Default | Modification |
|---------------|---|--|-----------|-----------------|--------------|
| F12.00 | Constant pressure water supply mode selection | 0: no constant pressure water supply 1: select inverter to achieve one drive two mode 2: select extend board to achieve one drive two mode 3: select extend board to achieve one drive three mode | 1 | 0 | × |

| | | | | | |
|--------|--|--|----------|----------|---|
| | | 4: select extend board to achieve one drive four mode 5: Select inverterY1,Y2 as the double pump timing alternate constant pressure water supply mode | | | |
| F12.01 | Target pressure setting | 0.000~long-distance pressure gage range | 0.001Mpa | 0.200Mpa | ○ |
| F12.02 | Sleep frequency threshold | 0.00Hz~upper limit frequency | 0.01Hz | 30.00Hz | ○ |
| F12.03 | Awake pressure threshold | 0.000~long-distance pressure gage range | 0.001Mpa | 0.150Mpa | ○ |
| F12.04 | Sleep delay time | 0.0~6000.0s | 0.1s | 0.0s | ○ |
| F12.05 | Revival delay time | 0.0~6000.0s | 0.1s | 0.0s | ○ |
| F12.06 | The range of long-distance manometer | 0.001~9.999Mpa | 0.001Mpa | 1.000Mpa | ○ |
| F12.07 | allowed deviation of upper limit frequency and lower limit frequency when add or reduce pump | 0.1~100.0% | 0.1% | 1.0% | ○ |
| F12.08 | Pump switch judging time | 0.2~999.9s | 0.1s | 5.0s | ○ |
| F12.09 | Electromagnetism contactor switching delay time | 0.1~10.0s | 0.1s | 0.5s | ○ |
| F12.10 | Automatic switching time interval | 0000~65535 minute | 1 | 0 | × |
| F12.11 | Revival mode selection | 0: Awake by the value of F12.03 1: Awake by the value of F12.12*F12.01 | 1 | 0 | ○ |
| F12.12 | Revival pressure coefficient | 0.01~0.99 | 0.01 | 0.75 | ○ |
| F12.13 | Reduce pump switching estimate time | 0.2~999.9s | 0.1s | 5.0 | ○ |
| F12.14 | Reserved | | | | |

F13—Traverse/ Fixed Length Control Function Parameter Group

| Function Code | Name | Set Range | Min. Unit | Factory Default | Modification |
|---------------|--------------------------------|--|-----------|-----------------|--------------|
| F13.00 | Traverse function selection | 0:traverse invalid 1:traverse valid | 1 | 0 | × |
| F13.01 | Traverse operating mode | Units digit: enter mode 0:automatically enter 1:terminal enter manually Tens digit: 0:variable swing 1:fixed swing Hundreds digit: traverse halt start mode selection 0:restart 1:start as previous halt record Thousands digit: traverse status reserve selection 0:no reserve 1:reserve | 1 | 0000 | × |
| F13.02 | Traverse frequency swing value | 0.0~50.0% | 0.1% | 10.0% | ○ |
| F13.03 | Sudden-Jump frequency | 0.0~50.0% | 0.1% | 2.0% | ○ |

6 Function parameter schedule graph

| | | | | | |
|--------|---|--|--------|---------|---|
| F13.04 | Traverse cycle | 0.1~999.9s | 0.1s | 10.0s | ○ |
| F13.05 | Triangular wave rising time | 0.0~98.0% (traverse cycle) | 0.1% | 50.0% | ○ |
| F13.06 | preset frequency of Traverse | 0.00~400.00Hz | 0.01Hz | 0.00Hz | ○ |
| F13.07 | Traverse preset frequency waiting time | 0.0~6000.0s | 0.1s | 0.0s | ○ |
| F13.08 | Setting length | 0~65535(m\cm\mm) | 1 | 0 | ○ |
| F13.09 | Number of pulses for axis per circle | 1~10000 | 1 | 1 | ○ |
| F13.10 | Axis perimeter | 0.01~655.35cm | 0.01cm | 10.00cm | ○ |
| F13.11 | Percentage of remaining length | 0.00%~100.00% | 0.01% | 0.00% | ○ |
| F13.12 | Length correction coefficient | 0.001~10.000 | 0.001 | 1.000 | ○ |
| F13.13 | After length arrival : record length manage | Units digit: Reserved Tens digit: Sets the unit of length 0: meter (m) 1: centimeter (cm) 2: millimeter (mm) Hundreds digit: Actions when the length is reached 0: Continue running 1: Shut down according to stopping mode 2: Loop length control Thousands digit: Software reset length (could be cleared by communication) 0: No operation 1: The current length is cleared 2: The current length and total length both cleared | 1 | 0000 | ○ |
| F13.14 | record length manage | Units digit: Stops the current length 0: Automatically cleared 1: Length is maintained Tens digit: Power-down length memory setting 0: Not stored 1: Stored Hundreds digit: length calculation at shutdown 0: The length is not calculated 1: Calculate the length | 0 | 011 | ○ |

F14—Vector Control Parameter Group

| Function code | Name | Set Range | Min. Unit | Factory Default | Modification |
|---------------|---|--|-----------|-----------------|--------------|
| F14.00 | Speed/torque control selection | 0: speed control 1: torque control (This parameter is valid when F00.24=1 or 2) | 1 | 0 | ○ |
| F14.01 | Speed loop high speed proportional gain | 0.1 ~ 40.0 (This parameter is valid when F00.24=1 or 2) | 0.1 | 20.0 | ○ |
| F14.02 | Speed loop high speed integral time | 0.001~10.000s (This parameter is valid when F00.24=1 or 2) | 0.001s | 0.040s | ○ |
| F14.03 | Speed loop low speed proportional gain | 0.1 ~ 80.0 (This parameter is valid when F00.24=1 or 2) | 0.1 | 20.0 | ○ |
| F14.04 | Speed loop low speed integral time | 0.001~10.000s (This parameter is valid when F00.24=1 or 2) | 0.001s | 0.020s | ○ |

| | | | | | |
|--------|---|--|--------|--------|---|
| F14.05 | Speed loop parameter switching frequency | 0.00Hz~20.00Hz (This parameter is valid when F00.24=1 or 2) | 0.01Hz | 5.00Hz | ○ |
| F14.06 | Low frequency power generation stability coefficient | 0 ~ 50 (This parameter is valid when F00.24=1) | 1 | 25 | ○ |
| F14.07 | Current loop proportional gain | 1~500 (This parameter is valid when F00.24=1 or 2) | 1 | 70 | ○ |
| F14.08 | Current loop integral time | 0.1~100.0ms (This parameter is valid when F00.24=1 or 2) | 0.1ms | 4.0ms | ○ |
| F14.09 | Motor-driven torque current limit value | 0.0~250.0% (This parameter is valid when F00.24=1 or 2 or 3) | 0.1% | 160.0% | ○ |
| F14.10 | Braking torque current limit value | 0.0~250.0% (This parameter is valid when F00.24=1 or 2) | 0.1% | 160.0% | ○ |
| F14.11 | Asynchronous motor flux-weakening control coefficient | 20.0~100.0% (This parameter is valid when F00.24=1 or 2) | 0.1% | 80.0% | ○ |
| F14.12 | Asynchronous motor Min. flux coefficient | 10.0~80.0% (This parameter is valid when F00.24=2) | 0.1% | 10.0% | ○ |
| F14.13 | Torque reference and limit channel selection | Units digit: Torque provision channel selection 0: Digital setting 1: AI1 Analog setting 2: AI2 Analog setting 3: Terminal UP/DOWN adjustment setting 4: communication provision(Communication address: 1D01) 5: EA11 Analog setting (expansion effective) 6: EA12 Analog setting (expansion effective) 7:rapid pulse setting (X8 terminal needs to choose the corresponding function) 8:terminal pulse width setting (X8 terminal needs to choose the corresponding function) Note: This parameter is valid when F00.24=1 or 2. Tens digit:Electric torque limit channel selection 0: Digital setting (determined by F14.09) 1: AI1 analog setting 2: AI2 analog setting 3: Terminal UP / DOWN adjustment setting 4: Reserved 5: EA11 analog Setting (Extended Valid) 6: EA12 analog setting (Extended Valid) 7: High-speed pulse setting (X8 terminals need to select the appropriate function) 8: Terminal pulse width setting (X8 terminals need to select the appropriate function) Note: The maximum value of 1 ~ 8 channels corresponds to F14.09 Hundreds digit: Braking torque limit channel selection 0: Digital setting (Determined by F14.10) 1: AI1 analog setting 2: AI2 analog setting 3: Terminal UP / DOWN adjustment setting 4: Reserved 5: EA11 analog Setting (Extended Valid) | 1 | 000 | ○ |

6 Function parameter schedule graph

| | | | | | |
|--------|--|---|------|------|---|
| | | <p>6: EA12 analog setting (Extended Valid)</p> <p>7: High-speed pulse setting (X8 terminals need to select the appropriate function)</p> <p>8: Terminal pulse width setting (X8 terminals need to select the appropriate function)</p> <p>Note: The maximum value of 1 ~ 8 channels corresponds to F14.10</p> | | | |
| F14.14 | Torque polarity setting | <p>0000~2112</p> <p>Units digit: torque setting polarity 0: positive 1: negative 2: defined by running command</p> <p>Tens digit: torque compensation polarity 0: The same as setting direction of torque 1: opposite the setting direction of torque</p> <p>Note: This parameter is valid when F00.24=1 or 2.</p> <p>Hundreds digit: F14.21 compensation weakened when the motor locked rotor 0: Invalid 1: Enable. This function prevents belt slippage caused by low frequency compensation F14.21 set too large or torque set too large and motor locked rotor.</p> <p>Thousands digit: Torque control anti-reverse function 0: Invalid 1: Anti-reverse function is active continuously 2: Anti-reversal function enabled at startup.</p> | 1 | 2000 | ○ |
| F14.15 | Torque digital setting value | 0.0~200.0% (This parameter is valid when F00.24=1 or 2) | 0.1% | 0.0% | ○ |
| F14.16 | Forward speed limit channel selection in Torque control mode | <p>0: Digital setting</p> <p>1: A11 Analog setting</p> <p>2: A12 Analog setting</p> <p>3: Terminal UP/DOWN adjustment setting</p> <p>4: Communication provision(Communication address: 1D0A).</p> <p>5: EA11 Analog setting (expansion effective)</p> <p>6: EA12 Analog setting (expansion effective)</p> <p>7: rapid pulse setting (X8 terminal needs to choose the corresponding function)</p> <p>8: terminal pulse width setting (X8 terminal needs to choose the corresponding function)</p> <p>Note: This parameter is valid when F00.24=1 or 2.</p> | 1 | 0 | × |
| F14.17 | Reverse speed limit channel selection in Torque control mode | <p>0: Digital setting</p> <p>1: A11 Analog setting</p> <p>2: A12 Analog setting</p> <p>3: Terminal UP/DOWN adjustment setting</p> <p>4: Communication provision(Communication address: 1D0B).</p> <p>5: EA11 Analog setting (expansion effective)</p> <p>6: EA12 Analog setting (expansion effective)</p> <p>7: Rapid pulse setting (X8 terminal needs to choose the corresponding function)</p> <p>8: Terminal pulse width setting (X8 terminal</p> | 1 | 0 | × |

| | | | | | |
|--------|--|--|--------|---------|---|
| | | needs to choose the corresponding function) Note: This parameter is valid when F00.24=1 or 2. | | | |
| F14.18 | Forward speed limit value in Torque control mode | 0.00Hz~upper limit frequency (This parameter is valid when F00.24=1 or 2.) | 0.01Hz | 50.00Hz | ○ |
| F14.19 | Reverse speed limit value in Torque control mode | 0.00Hz~upper limit frequency (This parameter is valid when F00.24=1 or 2.) | 0.01Hz | 50.00Hz | ○ |
| F14.20 | Torque Accelerate/Decelerate time setting | 0.000~60.000s (This parameter is valid when F00.24=1 or 2.) | 0.001s | 0.100s | ○ |
| F14.21 | Torque compensation | 0.0 ~ 100.0% (This parameter is valid when F00.24=1 or 2.) | 0.1% | 0.0% | ○ |
| F14.22 | Positive torque gain regulation coefficient | 50.0 ~ 150.0% (This parameter is valid when F00.24=1 or 2.) | 0.1% | 100.0% | ○ |
| F14.23 | Negative torque gain regulation coefficient | 50.0 ~ 150.0% (This parameter is valid when F00.24=1 or 2.) | 0.1% | 100.0% | ○ |
| F14.24 | Flux braking coefficient | 0.0 ~ 300.0% (This parameter is valid when F00.24=1 or 2.) | 0.1% | 0.0% | ○ |
| F14.25 | Pre-excitation start-up time constant | 0.1 ~ 3.0 (This parameter is valid when F00.24=1) | 0.1 | 0.5 | × |
| F14.26 | Speed loop proportional gain | 0.010 ~ 6.000 (This parameter is valid when F00.24=3) | 0.001 | 0.500 | ○ |
| F14.27 | Speed loop integral time constant | 0.010 ~ 9.999 (This parameter is valid when F00.24=3) | 0.001 | 0.360 | ○ |
| F14.28 | Motor stabilization coefficient | 10 ~ 300 (This parameter is valid when F00.24=3) | 1 | 100 | ○ |
| F14.29 | Compensation gain of vibration restrain | 100.0 ~ 130.0% (This parameter is valid when F00.24=3) | 0.1% | 100.0% | ○ |
| F14.30 | Torque compensation limit frequency | 0.00Hz~upper limit frequency (This parameter is valid when F00.24=1 or 2.) | 0.01Hz | 20.00Hz | ○ |

F15—Asynchronous Motor Parameter Group

| Function code | Name | Set Range | Min. Unit | Factory Default | Modification |
|---------------|---|---------------|-----------|--------------------|--------------|
| F15.00 | Reserved | | | | |
| F15.01 | Asynchronous motor rated power | 0.1~6553.5KW | 0.1KW | Base on motor type | × |
| F15.02 | Asynchronous motor rated voltage | 1~690V | 1V | Base on motor type | × |
| F15.03 | Asynchronous motor rated current | 0.1~6553.5A | 0.1A | Base on motor type | × |
| F15.04 | Asynchronous motor rated frequency | 0.00~600.00Hz | 0.01Hz | Base on motor type | × |
| F15.05 | Asynchronous motor rated rotational speed | 0~60000r/min | 1r/min | Base on motor type | × |
| F15.06 | Asynchronous motor poles No. | 1~7 | 1 | 2 | × |

6 Function parameter schedule graph

| | | | | | |
|--------|---------------------------------------|---|---------|--------------------|---|
| F15.07 | Asynchronous motor stator resistance | 0.001~65.535Ω (inverter power<7.5KW) | 0.001Ω | Base on motor type | × |
| | | 0.0001~6.5535Ω(inverter power≥7.5KW) | 0.0001Ω | | |
| F15.08 | Asynchronous motor rotor resistance | 0.001~65.535Ω (inverter power<7.5KW) | 0.001Ω | Base on motor type | × |
| | | 0.0001~6.5535Ω(inverter power≥7.5KW) | 0.0001Ω | | |
| F15.09 | Asynchronous motor leakage inductance | 0.01~655.35mH (inverter power<7.5KW) | 0.01mH | Base on motor type | × |
| | | 0.001~65.535mH (inverter power≥7.5KW) | 0.001mH | | |
| F15.10 | Asynchronous motor mutual inductance | 0.1~6553.5mH (inverter power<7.5KW) | 0.1mH | Base on motor type | × |
| | | 0.01~655.35mH (inverter power≥7.5KW) | 0.01mH | | |
| F15.11 | Asynchronous motor no load current | 0.01~655.35A | 0.01A | Base on motor type | × |
| F15.12 | Reserved | | | | |
| F15.13 | Reserved | | | | |
| F15.14 | Reserved | | | | |
| F15.15 | Reserved | | | | |
| F15.16 | Reserved | | | | |
| F15.17 | Reserved | | | | |
| F15.18 | Reserved | | | | |
| F15.19 | Motor parameter self-tuning selection | 0: Inaction 1: asynchronous motor stop to self-adjusting 2: asynchronous motor rotate no-load to self-adjusting 3: Reserved Note: ① Before adjustment, The nameplate data should be setting directly. ② Motor parameter group can have special default values, or can be modified by users, or can be self-adjusted. ③ when parameter F15.01 is modified, the other parameters of the motor will turn into default values automatically. | 1 | 0 | × |
| F15.20 | Reserved | | | | |
| F15.21 | Reserved | | | | |
| F15.22 | Reserved | | | | |

F16—Closed loop encoder parameter group

| Function code | Name | Set Range | Min. Unit | Factory Default | Modification |
|---------------|--------------------------|---|-----------|-----------------|--------------|
| F16.00 | Zero-speed servo enabled | 0: Zero-speed servo is invalid. 1: Zero-speed servo is valid. | 1 | 0 | ○ |
| F16.01 | Encoder line number | 1~10000 | 1 | 1024 | ○ |
| F16.02 | Direction of encoder | Units digit: AB phase sequence 0: Forward direction 1:Reverse direction Tens digit: Set of point positioning and seeking position direction. 0: Seeking position according to command direction. 1: Seeking position according to forward direction. | 1 | 00 | × |

| | | | | | |
|--------|---|--|--------|---------|---|
| | | 2: Seeking position according to reverse direction. 3: Seeking position according to random direction. | | | |
| F16.03 | Encoder fractional frequency coefficient | 0.001~60.000 | 0.001 | 1.000 | ○ |
| F16.04 | Encoder filtering coefficient | 5~100 | 1 | 15 | ○ |
| F16.05 | Position control mode | 0:Position control is invalid. 1:Point positioning mode. 2:Recovery point positioning mode 3~4:Reserved Remarks: 1, This parameter is valid while F00.24=2 2, While F16.05=1, need to cooperate with multi-function input terminal function of No.66. 3,While F16.05=2, need to cooperate with multi-function input terminal function of No.69. | 1 | 0 | × |
| F16.06 | Position control maximum frequency | 0.01~100.00Hz | 0.01Hz | 30.00Hz | × |
| F16.07 | Position control minimum frequency | 0.01~5.00Hz | 0.01Hz | 0.01Hz | × |
| F16.08 | Creeping afterpulse count before finishing the position | 0~60000 | 1 | 30 | ○ |
| F16.09 | Positioning reaches to the pulse range | 1~255 | 1 | 2 | ○ |
| F16.10 | Position control gain | 1~5000 | 1 | 200 | ○ |
| F16.11 | PSG alteration point | 0.01~30.00Hz | 0.01Hz | 5.00Hz | ○ |
| F16.12 | Point positioning relative to Z-axis angle | 0.00~360.00 degree | 0.01 | 0.00 | ○ |
| F16.13 | Positioning control acceleration-deceleration time | 1~60000 | 1 | 200 | ○ |

F17—Reserved Parameter Group 1

| Function code | Name | Set Range | Min. Unit | Factory Default | Modification |
|-----------------------|----------|-----------|-----------|-----------------|--------------|
| F17.00 ~ F17.20 | Reserved | | | | |

F18—Enhance Control Parameter Group

| Function code | Name | Set Range | Min. Unit | Factory Default | Modification |
|---------------|---|--|-----------|-----------------|--------------|
| F18.00 | Operation panel control frequency binding | 0:no binding 1:operation keyboard digital setup 2:A11 analog setup 3:A12 analog setup 4:terminal UP/DOWN adjusting setup 5:communication provide(Modbus and external bus use the same main frequency storage) 6:EAI1 analog setup(extension valid) | 1 | 0 | ○ |

6 Function parameter schedule graph

| | | | | | |
|--------|---|--|--------|---------|---|
| | | 7:EA12 analog setup(extension valid) 8:high speed pulse setup(X8 terminal need choose the relative function) 9:terminal pulse width setup(X8 terminal need choose the relative function) 10:terminal encoder provide(decide by X1, X2) 11~15: Reserved | | | |
| F18.01 | Terminal control frequency binding | Same as above | 1 | 0 | ○ |
| F18.02 | Communication control frequency binding | Same as above | 1 | 0 | ○ |
| F18.03 | Digital frequency integral function selection | Units digit: keyboard UP/DW integral control 0:integral function 1:no integral function Tens digit: terminal UP/DW integral control 0:integral function 1:no integral function Hundreds digit: Keyboard shuttle knob enable (shuttle keyboard effective) 0:The shuttle knob is valid in the monitoring interface 1:The shuttle knob is invalid in the monitoring interface Thousands digit: keypad adjustment of frequency classic mode selection 0: invalid 1: valid, adjustment range decided by F18.05 | 1 | 0000 | ○ |
| F18.04 | Keyboard UP/DOWN integral rate | 0.01~50.00Hz | 0.01Hz | 0.10Hz | ○ |
| F18.05 | Keyboard no integral single step's size setup | 0.01~10.00Hz | 0.01Hz | 0.01Hz | ○ |
| F18.06 | Terminal UP/DOWN integral rate | 0.01~50.00Hz | 0.01Hz | 0.20Hz | ○ |
| F18.07 | Terminal no integral single step's size setup | 0.01~10.00Hz | 0.01Hz | 0.10Hz | ○ |
| F18.08 | Droop control decline frequency | 0.00~10.00Hz | 0.01Hz | 0.00Hz | ○ |
| F18.09 | Setup accumulate power on time | 0~65535 hours | 1 | 0 | ○ |
| F18.10 | Setup accumulate run time | 0~65535 hours | 1 | 0 | ○ |
| F18.11 | Timing run function enable | 0: invalid 1: valid | 1 | 0 | ○ |
| F18.12 | Timing run stop time | 0.1~6500.0Min | 0.1Min | 2.0Min | ○ |
| F18.13 | Currently run arrival time | 0.0~6500.0Min | 0.1Min | 1.0Min | ○ |
| F18.14 | Keyboard UP/DOWN selection under monitor mode | 0:keybaord frequency provide value adjusting 1:PID digital provide value adjusting 2~6: Reserved | 1 | 0 | ○ |
| F18.15 | V/F vibration restrain end frequency | 0.00Hz~upper limit frequency | 0.01Hz | 50.00Hz | ○ |
| F18.16 | Advanced control functions | Units digit : the function of torque closed-loop control 0: torque open-loop control 1: torque closed-loop control Tens digit: Torque limit mode 0: Torque limit according to rated current of frequency converter 1: Torque limit according to rated torque current | 1 | 0001 | ○ |

| | | | | | |
|--------|--|---|----------|--------|---|
| | | <p>Hundreds digit : fast through function when less than the lower limit frequency 0: invalid 1: valid Thousands digit: in torque control mode, Low torque given PWM blocking function (Thousands digit is valid when F00.24=1) 0: invalid 1: valid</p> | | | |
| F18.17 | cooling fan control selection | <p>Units digit: Fan control mode 0:Smart fan 1:Inverter is running all the time after power on 2:No running for fan, but it starts automatically when the temperature is higher than 75 degree. Tens digit: Speed regulation fan control mode. 0:Smart PWM Speed regulation 1:Running at highest speed.</p> | 1 | 00 | ○ |
| F18.18 | No speed vector slip gain | 50%~200% (when F00.24=1,this function is valid) | 1% | 100% | ○ |
| F18.19 | Low-order of total power consumption | 0~9999 | 1kwh | 0 | ○ |
| F18.20 | High-order of total power consumption | 0~65535 (1represent 10000kwh) | 10000kwh | 0 | ○ |
| F18.21 | Correction factor of power consumption calculation | 50.0%~200.0% | 0.1% | 100.0% | ○ |
| F18.22 | V/F separate control voltage reference channel | <p>0: Digital setting (determined by 18.23) 1: AI1 analog setting 2: AI2 analog setting 3: Terminal UP / DOWN adjustment setting 4: Reserved 5: EA11 analog Setting (Extended Valid) 6: EA12 analog setting (Extended Valid) 7: High-speed pulse setting (X8 terminals need to select the appropriate function) 8: Terminal pulse width setting (X8 terminals need to select the appropriate function) Note: The maximum value of 0 ~ 8 channels correspond to the motor rated voltage</p> | 1 | 1 | ○ |
| F18.23 | V/F separate control voltage digital reference | 0.0%~100.0% | 0.1% | 0.0% | ○ |
| F18.24 | Low frequency slip gain | 30~300% | 1% | 100% | ○ |

F19—Protective Relevant Function Parameter Group

| Function code | Name | Set Range | Min. Unit | Factory Default | Modification |
|---------------|-----------------------------------|--|-----------|-----------------|--------------|
| F19.00 | Power off restart waiting time | 0.0~20.0s (0 means no start function) | 0.1s | 0.0s | × |
| F19.01 | Fault self-recovery times | 0~10 (0 means no automatic reset function) | 1 | 0 | × |
| F19.02 | Fault self-recovery interval time | 0.5~20.0s | 0.1s | 5.0s | × |
| F19.03 | Motor overload | 0:alarm; continuous run | 1 | 2 | ○ |

6 Function parameter schedule graph

| | | | | | |
|--------|--|--|----------|-----------|---|
| | protection action selection | 1:alarm, stop run as halt mode 2:fault, free halt | | | |
| F19.04 | Motor overload protection coefficient | 10.0~2000.0% (motor rated current) | 0.1% | 100.0% | ○ |
| F19.05 | Inverter overload pre-alarm detection selection | 0:detection all the time 1:detection as constant velocity | 1 | 0 | ○ |
| F19.06 | Inverter overload pre-alarm detection level | 20~180% (inverter rated current) | 1% | 130% | ○ |
| F19.07 | Inverter overload pre-alarm delay time | 0.0~20.0s | 0.1s | 5.0s | ○ |
| F19.08 | Motor underload alarm detection level | 0.0~120.0% (motor rated current) | 0.1% | 50.0% | ○ |
| F19.09 | Motor underload alarm detection time | 0.1~60.0s | 0.1s | 2.0s | ○ |
| F19.10 | Motor underload alarm detection action | Units digit: detection selection 0:no detection 1:detection all the time when run 2:detection only when constant velocity Tens digit: action selection 0:alarm, continuous run 1:alarm, stop run as halt mode 2:fault, free halt | 1 | 00 | ○ |
| F19.11 | Input& output phase loss, short circuit detection action | Units digit: input phase loss 0:no detection 1:fault, free halt Tens digit: output phase loss 0:no detection 1:fault, free halt Hundreds digit: power-on on earth short circuit protect detection enable 0:no detection 1:fault, free halt Thousands digit: operation on earth short circuit protect detection enable 0:no detection 1:fault, free halt | 1 | 1111 | ○ |
| F19.12 | Over voltage stall selection | 0:forbid 1:allowed | 1 | 1 | × |
| F19.13 | Over voltage stall protection voltage | 100~150% (rated busbar voltage) | 1% | 125% | × |
| F19.14 | Automatic current limit level | 50~230% (G type rated current) | 1% | 170% | × |
| F19.15 | Frequency decline rate of automatic current limit | 0.00~99.99Hz/s | 0.01Hz/s | 10.00Hz/s | × |
| F19.16 | Automatic current limit action selection | 0:constant velocity invalid 1:constant velocity valid | 1 | 0 | × |
| F19.17 | Rapid current-limiting coefficient | 150%~250% (G type rated current) | 1% | 230% | × |
| F19.18 | Motor run section selection when instant power off | 0:forbid 1:allowed | 1 | 0 | × |
| F19.19 | Frequency droop rate when instant power off | 0.00~99.99Hz/s | 0.01Hz/s | 10.00Hz/s | × |
| F19.20 | Voltage rebound | 0.00~10.00s | 0.01s | 0.10s | × |

| | | | | | |
|--------|---|--|-------|-------|---|
| | estimate time when instant power off | | | | |
| F19.21 | Action estimate voltage when instant power off | 60~100%(rated busbar voltage) | 1% | 80% | × |
| F19.22 | Allowed the longest off time when instant power off | 0.30~5.00s | 0.01s | 2.00s | × |
| F19.23 | Terminal external device fault action selection | 0:alarm, continuous run 1:alarm, stop run as halt mode 2:fault, free halt | 1 | 2 | × |
| F19.24 | Power on terminal protection selection | 0:invalid 1:valid | 1 | 0 | × |
| F19.25 | Provide lost detection value | 0~100% | 1% | 0% | ○ |
| F19.26 | Provide lost detection time | 0.0~500.0s | 0.1s | 0.5s | ○ |
| F19.27 | Feedback lost detection value | 0~100% | 1% | 12% | ○ |
| F19.28 | Feedback lost detection time | 0.0~500.0s | 0.1s | 0.5s | ○ |
| F19.29 | Deviation magnitude abnormal detection value | 0~100% | 1% | 50% | ○ |
| F19.30 | Deviation magnitude abnormal detection time | 0.0~500.0s | 0.1s | 0.5s | ○ |
| F19.31 | Protection action selection 1 | Units digit: PID provide loss detection act 0:no detection 1:alarm, continue run 2:alarm, stop run as halt mode 3:fault, free halt Tens digit: PID feedback loss detection act 0:no detection 1:alarm, continue run 2:alarm, stop run as halt mode 3:fault, free halt Hundreds digit: PID error value abnormal detect action 0:no detection 1:alarm, continue run 2:alarm, stop run as halt mode 3:fault, free halt | 1 | 000 | ○ |
| F19.32 | Protection action selection 2 | Units digit: communication abnormal action: include communication time out and error 0:alarm, continue run 1:alarm, stop run as halt mode 2:fault, free halt Tens digit: E ² PROM abnormal action selection 0:alarm, continue run 1:alarm, stop run as halt mode 2:fault, free halt Hundreds digit: contactor abnormal action 0:alarm, continue run 1:alarm, stop run as halt mode 2:fault, free halt Thousands digit: running lack-Voltage fault | 1 | 1200 | × |

6 Function parameter schedule graph

| | | | | | |
|--------|--|---|--------|---------|---|
| | | display action selection. 0:no detection 1:fault, free halt | | | |
| F19.33 | Reserved | | | | |
| F19.34 | Reserved | | | | |
| F19.35 | Fault indication and clock during the period of recovery | Units digit: fault indication selection during the period of fault reset automatically 0:action 1:no action Tens digit: fault clock function selection: to achieve fault display before power down: etc. 0:forbid 1:open | 1 | 00 | × |
| F19.36 | Continuous run frequency selection when alarm | Match up with protect action 0:run at the frequency setup by now 1:run at the frequency of upper limit 2:run at the frequency of low limit 3:run at the frequency of abnormal for standby | 1 | 0 | × |
| F19.37 | Abnormal standby frequency | 0.00Hz~upper limit frequency | 0.01Hz | 10.00Hz | × |
| F19.38 | Encoder disconnection detection time | 0.0~8.0s(No detection when value is 0) | 0.1s | 0.0s | ○ |
| F19.39 | Over speed (OS) detection time | 0.0~120.0%(equals upper limit frequency) | 0.1% | 120.0% | ○ |
| F19.40 | Over speed (OS) detection time | 0.00~20.00s (No detection when value is 0) | 0.01s | 0.00s | ○ |
| F19.41 | Detection value when speed deviation is too large | 0.0~50.0%(equals upper limit frequency) | 0.1% | 10.0% | ○ |
| F19.42 | Detection time when speed deviation is too large | 0.00~20.00s (No detection when value is 0) | 0.01s | 0.00s | ○ |
| F19.43 | Overvoltage suppression coefficient | 0.0~100.0% | 0.1% | 90.0% | ○ |
| F19.44 | Reserved | | | | |

F20—Internal Virtual Input Output Node Parameter Group

| Function code | Name | Set Range | Min. Unit | Factory Default | Modification |
|---------------|--|-----------|-----------|-----------------|--------------|
| F20.00 | Virtual input VDI1 function selection | 0~90 | 1 | 0 | ○ |
| F20.01 | Virtual input VDI2 function selection | 0~90 | 1 | 0 | ○ |
| F20.02 | Virtual input VDI3 function selection | 0~90 | 1 | 0 | ○ |
| F20.03 | Virtual input VDI4 function selection | 0~90 | 1 | 0 | ○ |
| F20.04 | Virtual input VDI5 function selection | 0~90 | 1 | 0 | ○ |
| F20.05 | Virtual output VDO1 function selection | 0~60 | 1 | 0 | ○ |
| F20.06 | Virtual output VDO2 function selection | 0~60 | 1 | 0 | ○ |
| F20.07 | Virtual output VDO3 function selection | 0~60 | 1 | 0 | ○ |

| | | | | | |
|--------|--|--|-------|-------|---|
| F20.08 | Virtual output VDO4 function selection | 0~60 | 1 | 0 | ○ |
| F20.09 | Virtual output VDO5 function selection | 0~60 | 1 | 0 | ○ |
| F20.10 | Virtual output VDO1 open delay time | 0.00~600.00s | 0.01s | 0.00s | ○ |
| F20.11 | Virtual output VDO2 open delay time | 0.00~600.00s | 0.01s | 0.00s | ○ |
| F20.12 | Virtual output VDO3 open delay time | 0.00~600.00s | 0.01s | 0.00s | ○ |
| F20.13 | Virtual output VDO4 open delay time | 0.00~600.00s | 0.01s | 0.00s | ○ |
| F20.14 | Virtual output VDO4 open delay time | 0.00~600.00s | 0.01s | 0.00s | ○ |
| F20.15 | Virtual output VDO1 close delay time | 0.00~600.00s | 0.01s | 0.00s | ○ |
| F20.16 | Virtual output VDO2 close delay time | 0.00~600.00s | 0.01s | 0.00s | ○ |
| F20.17 | Virtual output VDO3 close delay time | 0.00~600.00s | 0.01s | 0.00s | ○ |
| F20.18 | Virtual output VDO4 close delay time | 0.00~600.00s | 0.01s | 0.00s | ○ |
| F20.19 | Virtual output VDO5 close delay time | 0.00~600.00s | 0.01s | 0.00s | ○ |
| F20.20 | Virtual input VDI enable control | 00~FF | 1 | 00 | ○ |
| F20.21 | Virtual input VDI status digital setup | 00~FF | 1 | 00 | ○ |
| F20.22 | Virtual input/output connection | 00~FF Bit0:VDI1 and VDO1 connection 0:positive logic 1:negative logic Bit1:VDI2 and VDO2 connection 0:positive logic 1:negative logic Bit2:VDI3 and VDO3 connection 0:positive logic 1:negative logic Bit3:VDI4 and VDO4 connection 0:positive logic 1:negative logic Bit4:VDI5 and VDO5 connection 0:positive logic 1:negative logic | 1 | 00 | ○ |

F21—Reserved Parameter Group 2

| Function code | Name | Set Range | Min. Unit | Factory Default | Modification |
|-------------------|----------|-----------|-----------|-----------------|--------------|
| F21.00~ F21.21 | Reserved | | | | |

6 Function parameter schedule graph

| F22—Reserved Parameter Group 3 | | | | | |
|--------------------------------|----------|-----------|-----------|-----------------|--------------|
| Function code | Name | Set Range | Min. Unit | Factory Default | Modification |
| F22.00~F22.17 | Reserved | | | | |

| F23—Reserved Parameter Group 4 | | | | | |
|--------------------------------|----------|-----------|-----------|-----------------|--------------|
| Function code | Name | Set Range | Min. Unit | Factory Default | Modification |
| F23.00~F23.17 | Reserved | | | | |

| F24—Reserved Parameter Group 5 | | | | | |
|--------------------------------|----------|-----------|-----------|-----------------|--------------|
| Function code | Name | Set Range | Min. Unit | Factory Default | Modification |
| F24.00~F24.13 | Reserved | | | | |

| F25—User Definition Display Parameter Group | | | | | |
|---|-----------------------|---------------|-----------|-----------------|--------------|
| Function code | Name | Set Range | Min. Unit | Factory Default | Modification |
| F25.00 | User Function Code 1 | F00.00~F25.xx | 0.01 | 25.00 | ○ |
| F25.01 | User Function Code 2 | F00.00~F25.xx | 0.01 | 25.00 | ○ |
| F25.02 | User Function Code 3 | F00.00~F25.xx | 0.01 | 25.00 | ○ |
| F25.03 | User Function Code 4 | F00.00~F25.xx | 0.01 | 25.00 | ○ |
| F25.04 | User Function Code 5 | F00.00~F25.xx | 0.01 | 25.00 | ○ |
| F25.05 | User Function Code 6 | F00.00~F25.xx | 0.01 | 25.00 | ○ |
| F25.06 | User Function Code 7 | F00.00~F25.xx | 0.01 | 25.00 | ○ |
| F25.07 | User Function Code 8 | F00.00~F25.xx | 0.01 | 25.00 | ○ |
| F25.08 | User Function Code 9 | F00.00~F25.xx | 0.01 | 25.00 | ○ |
| F25.09 | User Function Code 10 | F00.00~F25.xx | 0.01 | 25.00 | ○ |
| F25.10 | User Function Code 11 | F00.00~F25.xx | 0.01 | 25.00 | ○ |
| F25.11 | User Function Code 12 | F00.00~F25.xx | 0.01 | 25.00 | ○ |
| F25.12 | User Function Code 13 | F00.00~F25.xx | 0.01 | 25.00 | ○ |
| F25.13 | User Function Code 14 | F00.00~F25.xx | 0.01 | 25.00 | ○ |
| F25.14 | User Function Code 15 | F00.00~F25.xx | 0.01 | 25.00 | ○ |
| F25.15 | User Function Code 16 | F00.00~F25.xx | 0.01 | 25.00 | ○ |
| F25.16 | User Function Code 17 | F00.00~F25.xx | 0.01 | 25.00 | ○ |
| F25.17 | User Function Code 18 | F00.00~F25.xx | 0.01 | 25.00 | ○ |
| F25.18 | User Function Code 19 | F00.00~F25.xx | 0.01 | 25.00 | ○ |
| F25.19 | User Function Code 20 | F00.00~F25.xx | 0.01 | 25.00 | ○ |
| F25.20 | User Function Code 21 | F00.00~F25.xx | 0.01 | 25.00 | ○ |
| F25.21 | User Function Code 22 | F00.00~F25.xx | 0.01 | 25.00 | ○ |
| F25.22 | User Function Code 23 | F00.00~F25.xx | 0.01 | 25.00 | ○ |
| F25.23 | User Function Code 24 | F00.00~F25.xx | 0.01 | 25.00 | ○ |
| F25.24 | User Function Code 25 | F00.00~F25.xx | 0.01 | 25.00 | ○ |
| F25.25 | User Function Code 26 | F00.00~F25.xx | 0.01 | 25.00 | ○ |

| | | | | | |
|--------|-----------------------|---------------|------|-------|---|
| F25.26 | User Function Code 27 | F00.00~F25.xx | 0.01 | 25.00 | ○ |
| F25.27 | User Function Code 28 | F00.00~F25.xx | 0.01 | 25.00 | ○ |
| F25.28 | User Function Code 29 | F00.00~F25.xx | 0.01 | 25.00 | ○ |
| F25.29 | User Function Code 30 | F00.00~F25.xx | 0.01 | 25.00 | ○ |

| F26—Fault Record Function Parameter Group | | | | | |
|---|------------------------------|--|-----------|-----------------|--------------|
| Function Code | Name | Set Range | Min. Unit | Factory Default | Modification |
| F26.00 | The last fault record | 0:no fault 1:overcurrent at acceleration 2:overcurrent at deceleration 3:overcurrent at constant speed 4:overvoltage at acceleration 5:overvoltage at deceleration 6:overvoltage at constant speed 7:overvoltage at motor halt 8:undervoltage at run 9:drive overload protection 10:motor overload protection 11:motor underload protection 12:input phase loss 13:output phase loss 14:inverter module protection 15:short circuit to earth at run 16:short circuit to earth when power on 17:drive overheat 18:external device fault 19:current detect circuit fault 20:external interference 21:internal interference—main clock etc 22:PID provide lost 23:PID feedback lost 24:PID error value abnormal 25:terminal protection activate 26:communication fault 27~29:reserve 30:EEROM read-write error 31:temperature detection disconnection 32:auto-tuning fault 33:contactor abnormal 34:factory fault 1 35:factory fault 2 36:capacitor overheat(few mode with overheat protection) 37:encoder disconnection 38:over-speed protection 39:protection when speed deviation is too large 40: Fault of Z pulse loses 41: Analog channel disconnected protection 42~50: Reserved | 1 | 0 | * |
| F26.01 | The last two fault records | Same as above | 1 | 0 | * |
| F26.02 | The last three fault records | Same as above | 1 | 0 | * |
| F26.03 | The last four fault | Same as above | 1 | 0 | * |

6 Function parameter schedule graph

| | records | | | | |
|--------|---|------------------------------|--------|--------|---|
| F26.04 | Setup frequency at the last one fault | 0.00Hz~upper limit frequency | 0.01Hz | 0.00Hz | * |
| F26.05 | Output frequency at the last one fault | 0.00Hz~upper limit frequency | 0.01Hz | 0.00Hz | * |
| F26.06 | Output current at the last one fault | 0.0~6553.5A | 0.1A | 0.0A | * |
| F26.07 | DC busbar voltage at the last one fault | 0.0~6553.5V | 0.1V | 0.0V | * |
| F26.08 | Module temperature at the last one fault | 0~125℃ | 1℃ | 0℃ | * |
| F26.09 | Input terminal status at the last one fault | | | 0 | * |
| F26.10 | Accumulated run time at the last one fault | 0~65535min | 1min | 0min | * |
| F26.11 | Setup frequency at the last two fault | 0.00Hz~upper limit frequency | 0.01Hz | 0.00Hz | * |
| F26.12 | Output frequency at the last two fault | 0.00Hz~upper limit frequency | 0.01Hz | 0.00Hz | * |
| F26.13 | Output current at the last two fault | 0.0~6553.5A | 0.1A | 0.0A | * |
| F26.14 | DC busbar voltage at the last two fault | 0.0~6553.5V | 0.1V | 0.0V | * |
| F26.15 | Module temperature at the last two fault | 0~125℃ | 1℃ | 0℃ | * |
| F26.16 | Input terminal status at the last two fault | | | 0 | * |
| F26.17 | Accumulated run time at the last two fault | 0~65535min | 1min | 0min | * |

F27—Password and Manufacturer Function Parameter Group

| Function Code | Name | Set Range | Min. Unit | Factory Default | Modification |
|---------------|-----------------------|-------------|-----------|-----------------|--------------|
| F27.00 | User password | 00000~65535 | 1 | 00000 | ○ |
| F27.01 | Manufacturer password | 00000~65535 | 1 | 00000 | ○ |

C—Monitor Function Parameter Group

| Function Code | Name | Set Range | Min. Unit | Factory Default | Modification |
|---------------|--|-----------|-----------|-----------------|--------------|
| C-00 | Display the parameter of F00.01, F00.07 definition | | | | |
| C-01 | Display the parameter of F00.02, F00.08 definition | | | | |
| C-02 | Display the parameter of F00.03, F00.09 definition | | | | |
| C-03 | Display the parameter of F00.04, F00.10 definition | | | | |
| C-04 | Display the parameter of F00.05, F00.11 definition | | | | |
| C-05 | Display the parameter of F00.06, F00.12 definition | | | | |

(1)Corresponding relationship of input terminal status as below:

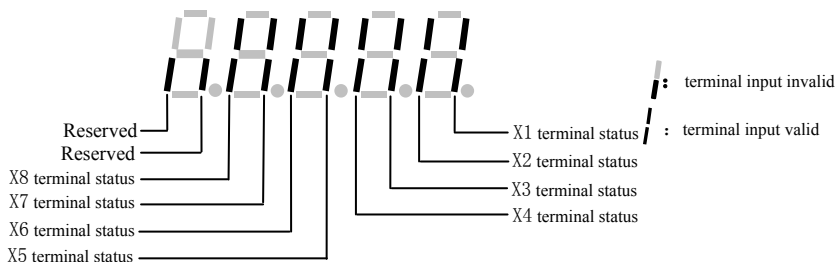

(2)Corresponding relationship of standard output terminal status as below:

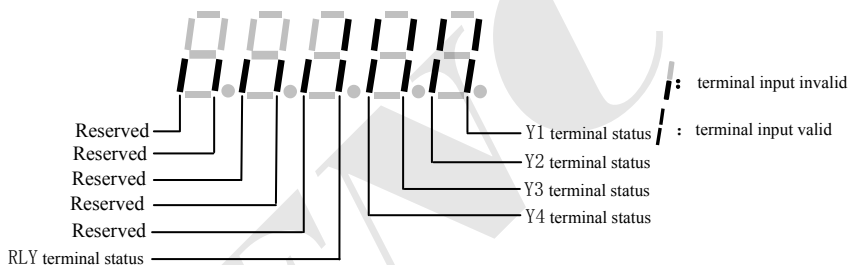

(3)Corresponding relationship of communication virtual input terminal status as below:

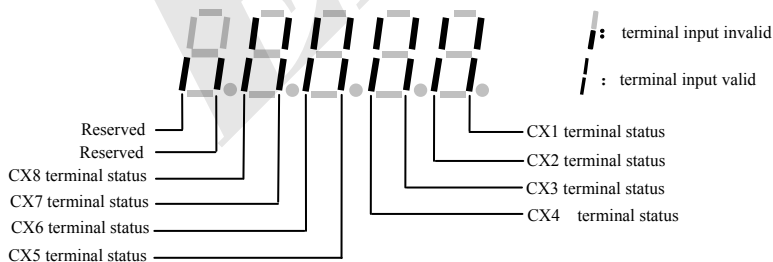

(4)Drive status:

- BIT0:1=busbar voltage setup
- BIT1:1=common run command valid
- BIT2:1=jog run command valid
- BIT3:1=drive run period
- BIT4:1=current run direction to reverse

BIT5:1=run command direction to reverse
BIT6:1=deceleration brake period
BIT7:1=motor acceleration period
BIT8:1=motor deceleration period
BIT9: 1= drive alarm
BIT10: 1= drive fault
BIT11: 1= current limited period
BIT12: 1= fault self-recovery period
BIT13: 1= self-adjusting period
BIT14: 1= free halt status
BIT15: 1= speed tracking start

ENC

7 Detailed function specification

The parameter function code of this chapter listed content as below:

| Code No. | Description | Setup Range/Explanation | Factory Default |
|----------|-------------|-------------------------|-----------------|
|----------|-------------|-------------------------|-----------------|

7.1 System Parameter Group: F00

| F00.00 | Parameter group display control | Range: 0~3 | 2 |
|--------|---------------------------------|------------|---|
|--------|---------------------------------|------------|---|

0: Basic list mode. Display only F00, F01, F02, F03 basic control parameter group and F26 fault record parameter group.

1: Middle list mode. Display all parameter except for extension: virtual and reserve parameter group.

2: Senior list mode. All parameter groups can be displayed.

3: User list mode. Display parameter defined by user: and monitor parameter: F00.00 display all the time.



Note

F00.00 display all the time. Under intermediate menu mode: irrelevant parameter group can be covered according to different control mode.

| | | | |
|--------|---|-------------|----|
| F00.01 | C-00 display parameter selection when operation | Range: 0~65 | 51 |
| F00.02 | C-01 display parameter selection when operation | Range: 0~65 | 2 |
| F00.03 | C-02 display parameter selection when operation | Range: 0~65 | 4 |
| F00.04 | C-03 display parameter selection when operation | Range: 0~65 | 5 |
| F00.05 | C-04 display parameter selection when operation | Range: 0~65 | 6 |
| F00.06 | C-05 display parameter selection when operation | Range: 0~65 | 9 |

The above parameter display when inverter run by C-00~C-05 parameter groups, pressing to switch between these parameters.



Pressing and then return to C-00 parameter monitor.



For example: pressing parameter switch from C-00 to C-01: continuous pressing the same button: parameter switch from C-01 to C-02: then pressing return to C-00 parameter monitor.

- 0: Main setup frequency (0.01Hz)**
- 1: Auxiliary setup frequency (0.01Hz)**
- 2: Setup frequency (0.01Hz)**
- 3: Output frequency (0.01Hz)**
- 4: Output current(0.1A)** (display 0.01A below 11KW)
- 5: Output voltage (1V)**
- 6: DC busbar voltage (0.1V)**
- 7: Motor speed (1 circle/min)**
- 8: Motor line velocity (1 circle/min)**
- 9: Inverter temperature (1℃)**
- 10: Run time already this time (0.1min)**
- 11: Current accumulate run time (1h)**
- 12: Current accumulate power-on time (1h)**
- 13: Inverter status** (displays the working state of inverter, show it with decimalism, after change it into binary, the definition is on the parameter details.)
- 14: Input terminal status**
- 15: Output terminal status**
- 16: Extension output terminal status**
- 17: Extension input terminal status**
- 18: Communication virtual input terminal status**
- 19: Internal virtual input node status**
- 20: Analog input AI1 (after checkout)(0.01V / 0.01mA)**
- 21: Analog input AI2 (after checkout)(0.01V / 0.01mA)**
- 22: Extension analog input EAI1 (after checkout)(0.01V / 0.01mA)**
- 23: Extension analog input EAI2 (after checkout)(0.01V / 0.01mA)**
- 24: Analog AO1 output (after checkout) (0.01V / 0.01mA)**
- 25: Analog AO2 output (after checkout) (0.01V or 0.01mA)**
- 26: Extension analog EAO1 output (0.01V / 0.01mA)**
- 27: Extension analog EAO2 output (0.01V / 0.01mA)**
- 28: External pulse input frequency (1Hz)**
- 29: Reserved**
- 30: Process PID provide (0.01V)**
- 31: Process PID feedback (0.01V)**
- 32: Process PID deviation (0.01V)**
- 33: Process PID output (0.01Hz)**
- 34: Simple PLC current segment No.**
- 35: External multi-speed current segment No.**

- 36: Constant pressure water supply provide pressure (0.001Mpa)**
37: Constant pressure water supply feedback pressure (0.001Mpa)
38: Constant pressure water supplies relay status
39: Current length (1M)
40: Accumulate length (1M)
41: Current internal count value
42: Current internal time value (0.1s)
**43: Run command setup channel (0: keyboard 1: terminal
2: communication)**
44: Main frequency provide channel
45: Auxiliary frequency provide channel
46: Rated current (0.1A)
47: Rated voltage (1V)
48: Rated power (0.1KW)
49, 50: Reserved
51: The frequency after deceleration (0.01Hz)
**52: Motor rotator frequency (0.01Hz) (the frequency estimate on the
open-loop ,actual measurement for close-loop)**
53 :Present provide torque (relative to rated torque, it has direction)
54: Present output torque (relative to rated torque, it has direction)
55: Present torque current (0.1A)
56: The present flux current (0.1A)
57: Setting motor rotate speed (r/min)
58: Output power (active power) (0.1KW)
59~65: Reserved

| | | | |
|--------|--|-------------|----|
| F00.07 | C-00 display parameter selection when stop | Range: 0~65 | 2 |
| F00.08 | C-01 display parameter selection when stop | Range: 0~65 | 6 |
| F00.09 | C-02 display parameter selection when stop | Range: 0~65 | 48 |
| F00.10 | C-03 display parameter selection when stop | Range: 0~65 | 14 |
| F00.11 | C-04 display parameter selection when stop | Range: 0~65 | 20 |
| F00.12 | C-05 display parameter selection when stop | Range: 0~65 | 9 |

The above parameter display when inverter stop by C-00~C-05 parameter group, pressing  to switch between these parameters. Pressing  and then

return to C-00 parameter monitor. For example: pressing  parameter switch from C-00 to C-01, continuous pressing the same button: parameter switch from C-01 to C-02: then pressing  return to C-00 parameter monitor. Monitor contents various as different monitor parameter: refer to parameter F00.01.



Note

Monitor parameter group C-00~C-05 have run and stop modes. For example C-00 display different physical value under run and stop two modes.

| | | | |
|---------------|---|-------------------|----------|
| F00.13 | Power-on fault monitor parameter selection | Range: 0~5 | 0 |
|---------------|---|-------------------|----------|

When the parameter power on first time: C monitor parameter group display under drive run or stop status, For example F00.13=1, power on or stop to monitor, display parameter setup by C-01;when F00.02=3, F00.08=6, power on, inverter stops, busbar voltage display; inverter runs, output frequency and keypad display. Pressing  monitor C-00 for the setting motor value.

| | | | |
|---------------|------------------------------------|--|------------|
| F00.14 | Parameter operation control | Range: units digit: 0~2 tens digit: 0~5 hundreds digit: 0~4 | 000 |
|---------------|------------------------------------|--|------------|

Units digit: To define which parameters will be allowed to modify.

0: All parameters are allowed to modification.

1: Except this parameter, the other parameter is not allowed to modification.

2: Except F01.01, F01.04 and this parameter, the others parameter are not allowed to modification.

Tens digit: To define which parameters will be resumed factory default value

0: No action.

1: All parameters return to default.(not include fault record parameter group(F26 group) parameter).

2: Except for motor parameter: all parameters return to default. (not include F15 and F26 group parameter).









3: Extension parameter return to default.(only F21~F24 group parameter return to default).

4: Virtual parameter return to default.(only F20 group parameter return to default).

5: Fault record return to default. (Only fault record parameter group (F26 group) restores factory default).



Hundreds digit: Locked key that definite the keypad when locking function is valid.

0: All locked.

- 1: Except  button: the others locked.
- 2: Except , ,  button: the others locked
- 3: Except ,  button: the others locked
- 4: Except ,  button: the others locked



Note

1. In factory status, the unit of this function code parameter is 0, and it is default and allowed to change all the other function code parameters: when user finish: and want to change the function code setup: this function code parameter should set up 0 first. When all changes finish and need to do parameter protect: this function code setup into the IP grade you need.
2. The decade recovers to 0 automatically after record remove or factory default operation.
3. When the third of parameter F00.14 finish setup:  button pressing lasting for 2 seconds to lock keyboard and relevant keyboard key: when need to unlock the keyboard: press the  button for 2 seconds.

| | | | |
|--------|---------------------------|---|------|
| F00.15 | Button function selection | Range: units digit: 0,1 tens digit: 0~9 hundreds digit: 0,1 thousands digit: 0,1 | 0001 |
|--------|---------------------------|---|------|

Units digit: panel  button selection

0: Reversal command action button

1: Jog action button

Tens digit: multi-function  button function selection

0: Invalid.

1: Jog run. Multi-function button as jog run button: run direction decided by unit bit of F01.16. After setting  function, the jog run function on the keypad is invalid.

2: For/rev switching. Press this button to change the run direction when run: then press the same button change to another direction. This function key is not used as start key, only for signal switch

3: Free stop. Setup free stop function and stop mode F02.11 the same function with 1 Jog run.

4: Switching to run command provide mode as the setup order of F00.16.

5: For/rev torque switching. After this function is valid, it can realize the

direction switching after torque model.

6~9: Reserved

Hundredth: terminal run command control

0: keypad  **is invalid.**

1: keypad  **is valid.**

Thousandth: communication run command control

0: keypad  **is invalid.**

1: keypad  **is valid.**

| | | | |
|---------------|---|-------------------|----------|
| F00.16 | Multi-function key run command channel switching order selection | Range: 0~3 | 0 |
|---------------|---|-------------------|----------|

0: Keyboard control→terminal control→communication control

1: Keyboard control←→terminal control

2: Keyboard control←→communication control

3: Terminal control←→communication control

These parameters cooperate with multi-function key to run command channel switching function: with special switch to command channel switching order.

- 1. Command channel priority terminal switch to (terminal function code 49,50,51)→terminal run command channel selection (terminal function code 52,53)→multi-function key switch→F01.15, when switching to terminal control, be sure the terminal command invalid. Terminal switch to and terminal run command channel selection refer to F08 group parameter about the detailed description of terminal function.**
- 2. We suggest alter the mode at the stop state.**



Note

| | | | |
|---------------|--|--------------------------|---------------|
| F00.17 | Motor speed display coefficient | Range: 0.1~999.9% | 100.0% |
|---------------|--|--------------------------|---------------|

This function code is used to check speed scale display error, there is no effect to motor actual speed.

| | | | |
|---------------|--|--------------------------|-------------|
| F00.18 | Line velocity display coefficient | Range: 0.1~999.9% | 1.0% |
|---------------|--|--------------------------|-------------|

This function code is used to check speed scale display error, there is no effect to motor actual speed.

| | | | |
|---------------|--------------------------------|--------------------|----------|
| F00.19 | Extended Port parts set | Range: 0~10 | 0 |
|---------------|--------------------------------|--------------------|----------|

0: Expansion card invalid

1: Reserved

2: Multi pump water supply card

3: Incremental PG encoder**4~10: Reserved**

This function is for extended port expansion card parameter, after setting expansion card, F00.19 will choose the expansion card number accordingly, then we can use the expansion card normally. For example, when Extended Port add PG expansion card, F00.19 should be set to 3.

| | | | |
|---------------|--|---|-------------|
| F00.20 | Analog input terminal configuration | Range: units digit: 0,1 tens digit: 0,1 hundreds digit: 0~2 thousands digit: 0~2 | 0000 |
|---------------|--|---|-------------|

This parameter can configure analog input AI1, AI2, EAI1, EAI2 to be current input type or voltage input type.

Units digit: AI1 configuration

0:0~10V input

1:4~20mA input

Tens digit: AI2 configuration

0:-10~10V input

1:4~20mA input

Hundreds digit: EAI1 configuration

0:0~10V input

1:-10~10V input

2:4~20mA input

Thousands digit: EAI2 configuration

0:0~10V input

1:-10~10V input

2:4~20mA input



Note

Dial switching(SW1,SW2)under the left corner of CPU to the corresponding position: when AI1,AI2 configuration.

| | | | |
|---------------|---|---|-------------|
| F00.21 | Analog output terminal configuration | Range: units digit: 0,1 tens digit: 0,1 hundreds digit: 0,1 thousands digit: 0,1 | 0000 |
|---------------|---|---|-------------|

This parameter can configure AO1, AO2, EAO1, EAO2 analog signal output to be voltage type or current type.

Units digit: AO1 configuration

0:0~10V output

1:4~20mA output

Tens digit: AO2 configuration

0:0~10V output**1:4~20mA output**

Hundreds digit: EAO1 configuration

0:0~10V output**1:4~20mA output**

Thousands digit: EAO2 configuration

0:0~10V output**1:4~20mA output****Note**

Dial switching(SW1,SW2)under the left corner of CPU to the corresponding position: when AI1,AI2 configuration.

| | | | |
|---------------|--|--|-------------|
| F00.22 | Y output terminal configuration | Range: units digit: Reserved tens digit: Reserved hundreds digit: Reserved thousands digit: 0,1 | 0000 |
|---------------|--|--|-------------|

Units digit ~ hundreds digit: Reserved

Thousands digit: Y4 output configuration

0: Open collector output**1: DO output**

The thousands digit decide the Y4 output terminal type, when 0 means open collector output, when 1 means high speed pulse DO output.

| | | | |
|---------------|-----------------------|--------------------|----------|
| F00.23 | G/P type setup | Range: 0, 1 | 0 |
|---------------|-----------------------|--------------------|----------|

0:G type. Adapt to constant torque load type.**1:P type.** Adapt to fan & pump load type.

EN500/EN600 integrates G/P type design in full power range. F15 group motor relative parameter will change automatically according to the G or P type.

**Note**

P type machine only can support V/F control .

| | | | |
|---------------|----------------------------|-------------------|----------|
| F00.24 | Motor control model | Range: 0~2 | 0 |
|---------------|----------------------------|-------------------|----------|

0: V/F control

If we need to start the fan and water pump application , or the inverter should drive one more AC motors, please choose the V/F control mode, when drive parts of the synchronous machines, we also can choose V/F control.

1: Speedless Vector Control 1 (Comparing with the speed vector control 2, the mode is more suitable to control the induction motor below 160KW, supporting the speed and torque control)

Speedless sensor vector control run mode, mainly used to velocity control, torque

control in the application site which require high control performance. To get better control performance, we need to set up motor parameter group F15 according to the motor nameplate details, and doing the self-learning to motor parameter. One VFD can only drive one motor in vector control mode, and VFD power need match up with motor, normally one class less or more of the VFD power than motor is allowed.

2: with speed sensor vector control (support the speed and torque control)

When choose the closed-loop vector control mode, the AC motor should be installed with an encoder, and the inverter should be installed with the same type of the encoder. It can be used on the high-accuracy speed control & torque control application. One inverter only can drive one AC motor, like Paper-make machine, cranes, and elevator.

When using the closed-loop control, including setting motor parameter (F15 group), we should also set the encoder parameter group (F16),and the Extended Port (F00.19) parameter.

| | | | |
|---------------|--------------------------------------|---------------------|----------|
| F00.25 | Monitor parameter 2 selection | Range : 0~65 | 4 |
|---------------|--------------------------------------|---------------------|----------|

When user choose EN-LED4-D keypad , under monitoring mode we can use F00.25 parameter to modify monitoring content of keypad digital display (LED2). When user choose EN-LCD1 or EN-LCD2 keypad, under monitoring mode we can use F00.25 parameter to change monitoring content of below LED.

For monitoring content of F00.25 parameter, please refer to description of F00.01

| | | | |
|---------------|----------------------------------|----------------------------|--------------|
| F00.26 | Busbar voltage adjustment | Range : 0.900~1.100 | 1.000 |
|---------------|----------------------------------|----------------------------|--------------|

We can use this parameter to adjust the busbar voltage; to make the inverter bus voltage is accordingly to the exact figures.

| | | | |
|---------------|---|--|-----------|
| F00.27 | Parameter copying and language selection | Range: units digit: 0~2 tens digit: 0~3 | 00 |
|---------------|---|--|-----------|

Units digit: language selection. (Only valid for LCD keypad)

0: Chinese

1: English

2: Reserve

Tens digit: parameter upload and download(valid for LCD and digital potentiometer keypad)

0: No action

1: parameter upload

2: parameter upload 1 (without motor parameter)

3: parameter upload 2 (with motor parameter)

When all motors carried by inverters are the same type in one system, we can use parameters download 1. Otherwise, use the parameters download 2.

7.2 Basic Run Function Parameter Group:F01

| | | | |
|---------------|---|--------------------|----------|
| F01.00 | Main frequency input channel selection | Range: 0~14 | 0 |
|---------------|---|--------------------|----------|

Total 15 types input channel for selection to chose inverter input channel of the main provide frequency,among 11~14 are reserve channel,currentlly there is no corresponding function.

0:Operation keyboard digital setup. When main frequency setup initial value to F01.01: modify F01.01 parameter to change main setting frequency with operation keyboard: or with \wedge , \vee button to modify the value of F01.01

1:AI1 analog setup. Main frequency setup confirmed by AI1 analog voltage/ current, input range: 0~10V (AI1 jumper wire selection V side)or 4~20mA(AI1 jumper wire selection A side).

2:AI2 analog setup. Main frequency setup confirmed by AI2 analog voltage/current, input range: -10~10V (AI2 jumper wire selection V side)or 4~20mA(AI2 jumper wire selection A side).

3:Terminal UP/DOWN adjusting setup. When main frequency initial value is parameter F01.01, through terminal UP/DOWN function to adjust the main setting frequency. Terminal function setup into 16(frequency increase progressively (UP))or 17(frequency decrease progressively control(DOWN)).

4:Communication provide(Communication address:1E01). Main frequency provide by selection communication mode.

5:EAI1 analog setup. When extension analog input EAI1 is valid,main frequency confirmed by EAI1 analog voltage/current,input range:-10~10V(EAI1 jumper wire selection V side)or 4~ 20mA(EAI1 jumper wire selection A side). Relevant extension card selection needed to use this setup function.

6:EAI2 analog setup. when extension analog input EAI2 valid,main frequency setup by EAI2 analog voltage / current,input range:-10~10V(EAI2 jumper wire selection V side) or 4~ 20mA(EAI2 jumper wire selection A side). Relevant extension card selection needed to use this setup function.

7:High speed pulse setup. main frequency setup by frequency signal of terminal pulse(only X8 input),input pulse specification:voltage range 15~30V; frequency range 0.00~50.00KHz.

8:Terminal pulse setup. main frequency setup by pulse width signal of terminal pulse(only X8 input),input pulse specification:voltage range 15~30V; pulse width range 0.1~999.9ms.

9:Terminal encoder setup.main frequency setup by terminal encoder pulse(only combination input by X1 and X2) and frequency velocity set by parameter F08.30.

10~14: Reserved



Note

Analog provide is positive and negative polarity control,its prior to command direction control: when main frequency provide is AI2,EAI1,EAI2: and setup provide to be -10~10V,run direction confirmed by analog provide signal polarity completely,when PID run is valid, run direction confirmed by PID error polarity and parameter F11.21 completely.



Excerpt terminal encoder provide (F01.00=9), main and auxiliary provide channel cannot be set into the same frequency source: if they are the same: then panel would be light (ALM) and display A-51.

| | | | |
|--------|------------------------------|------------------------------------|---------|
| F01.01 | Main frequency digital setup | Range:0.00Hz~upper limit frequency | 50.00Hz |
|--------|------------------------------|------------------------------------|---------|

When F01.00=0,3 or 4,F01.01 is the initial value of main frequency.

| | | | |
|--------|--------------------------------|--------------|----|
| F01.02 | Main frequency digital control | Range: 00~11 | 00 |
|--------|--------------------------------|--------------|----|

Units digit: power down reserve setup

0:Main frequency power down reserve. When main frequency channel provide is valid, power down in run status, current main frequency of run frequency is recorded in parameter F01.01.

1: Main frequency power down no reserve.

Tens digit: halt reserve setup

0:Halt main frequency hold. When main frequency channel provide is valid, current run frequency only recorded after halt.

1:Halt main frequency recovery F01.01. main setting frequency recorded in software is recovery to value of parameter F01.01 after halt.

Hundreds digit: Set of communication presetting frequency dimension.(It is valid for both main and salve frequency communication presetting)

0:Preset of absolute frequency mode(preset 5000 represent 50.00Hz).

1:Preset 10000 represent upper limit frequency (F01.11).



Note

Only when parameter F01.00=0, 3, 4, it can be valid, after power-fail or Stop storage function both are valid,stop the machine first, it also can serve.

| | | | |
|--------|--|--------------|----|
| F01.03 | Auxiliary frequency input channel select | Range : 0~20 | 20 |
|--------|--|--------------|----|

VFD auxiliary provides frequency input channel has 21 input channels for selection, for them 11~20 are Reserved channels, and currently there is no relevant function:

0:Keyboard operation digital setup. When auxiliary frequency setup initial value is parameter F01.04, modify parameter F01.04 to change auxiliary setting frequency: or with $\text{\textcircled{^}}$, $\text{\textcircled{v}}$ button modify the value of parameter F01.04

1:AI1 analog setup. Auxiliary frequency setup confirmed by AI1 analog voltage /current, input range: 0~10V (AI1 jumper wire selection V side)or 4~20mA(AI1 jumper wire A side).

2:AI2 analog setup. Auxiliary frequency setup confirmed by AI2 analog voltage/current, input range: -10~10V (AI2 jumper wire selection V side) or 4~20mA (AI2 jumper wire selection A side).

3:Terminal UP/DOWN adjusting setup. Auxiliary frequency initial value is parameter F01.04, through terminal UP/DOWN function to adjust auxiliary setting frequency.

4:communication setting(Communication address:1E01). The initial value of auxiliary frequency is for F01.04, it will determine by F05.00 of the communication setting.

5:EAI1 analog setup. When extension analog input EAI1 is valid, auxiliary frequency setup confirmed by EAI1 analog voltage/current, input range: -10~10V (EAI1 jumper wire selection V side)or 4~20mA(EAI1 jumper wire selection A side).

6:EAI2 analog setup. When extension analog input EAI2 is valid, auxiliary frequency setup confirmed by EAI2 analog voltage/current, input range: -10~10V (EAI2 jumper wire selection V side) or 4~20mA (EAI2 jumper wire selection A side).

7:High speed pulse setup. Auxiliary frequency setup by frequency signal of terminal pulse (only X8 input), input pulse specification: voltage range 5~30V; frequency range 0.00~50.00 KHz.

8:Terminal pulse width setup. Auxiliary frequency setup by pulse width signal of terminal pulse (only X8 input), input pulse specification: voltage range 15~30V; pulse width range 0.1~999.9ms.

9:Terminal encoder provide. Auxiliary frequency setup by terminal encoder pulse (only X3 or X4 input), 0.01Hz is a fixed adjusting precision.

10: Reserved.

11: Process PID Setting. Through the main frequency setting and the auxiliary frequency setting, can realize PID with feed forward control, which can make the system be into a steady state quickly. Generally, it is used in the scene of the process closed loop control, such as constant pressure closed loop control, constant tension closed-loop control, etc.

12~20: Reserved.



Note

Analog provide is positive and negative polarity control, its prior to command direction control: when auxiliary frequency provide is AI2, EAI1, EAI2, and setup provide is to be -10~10V, run direction confirmed by analog provide signal polarity completely.



Except terminal encoder provide (F01.03=9), main and auxiliary provide channel cannot setup to the same frequency source, when they are the same, then panel light (ALM), and A-51 display.

| | | | |
|--------|-----------------------------------|-------------------------------------|--------|
| F01.04 | Auxiliary frequency digital setup | Range: 0.00Hz~upper limit frequency | 0.00Hz |
|--------|-----------------------------------|-------------------------------------|--------|

When F01.03=0, 3 or 4, F01.04 is the initial frequency value of auxiliary frequency.

| | | | |
|--------|-------------------------------------|--------------|----|
| F01.05 | Auxiliary frequency digital control | Range: 00~11 | 11 |
|--------|-------------------------------------|--------------|----|

Units digit: power down reserve setup

0: Auxiliary frequency power down reserve. When auxiliary frequency channel provide is valid and power down at run mode, the current auxiliary setting frequency reserve in parameter F01.04.

1: Auxiliary frequency power down no reserve.

tens digit: halt reserve setup

0: Halt auxiliary frequency hold. When auxiliary frequency channel provide is valid, recording current run frequency only after halt.

1: Halt auxiliary frequency recovery parameter F01.04. auxiliary setting frequency in software recording is recovered the value of parameter F01.04 after halt.



Note

Only when F01.03=0,3,4 is valid.

| | | | |
|--------|--|------------|---|
| F01.06 | Main and auxiliary provide calculating setup | Range: 0~8 | 0 |
|--------|--|------------|---|

This parameter is to select frequency provide channel: and through the complex of main frequency source and auxiliary frequency source to achieve frequency provide.

0:Main frequency. Complex frequency of current is main frequency.

1: Auxiliary frequency. Complex frequency of current is auxiliary frequency.

2: Plus(polarity oppose of complex and main frequency,complex frequency is zero).

3:Minus(polarity oppose of complex and auxiliary frequency,complex frequency is zero).

4:Multiplication(polarity opposed of main and auxiliary frequency: complex frequency is zero).

5:Max(the max frequency of main and auxiliary absolute value).

6:Min(the min frequency of main and auxiliary absolute value).

7:Selection no-zero value(auxiliary is not negative,main frequency prior;auxiliary is negative,complex frequency is zero)

8:main frequency × Auxiliary frequency×2/F01.11. (polarity opposed of main and auxiliary frequency complex frequency is zero, can realize the fine tuning based on the main frequency).

1.The initial polarity of main and auxiliary frequency cannot change after main and auxiliary operation.

2.When main and auxiliary frequency channel are complex value,and both setup into power down reserve: parameter F01.01 and F01.04 reserve separately the changed part of main frequency and auxiliary frequency in the complex frequency when power down.



Note

| | | | |
|--------|---|--------------------|------|
| F01.07 | Auxiliary frequency provide coefficient | Range : 0.00~10.00 | 1.00 |
|--------|---|--------------------|------|

Parameter F01.07 can adjust auxiliary provide frequency gain.

| | | | |
|--------|---|-------------------|------|
| F01.08 | Coefficient after complex of main and auxiliary frequency | Range: 0.00~10.00 | 1.00 |
|--------|---|-------------------|------|

This parameter is to setup frequency flexibly and calculates the gain of complex setting frequency by main and auxiliary frequency.

| | | | |
|--------|-------------------------------------|-------------|---|
| F01.09 | Auxiliary frequency range selection | Range: 0, 1 | 0 |
|--------|-------------------------------------|-------------|---|

0:Relative high limit frequency. Auxiliary frequency setup range: 0.00Hz~high limit frequency×F01.10.

1:Relative main frequency. Auxiliary frequency setup range: 0.00Hz~main

frequency×F01.10.

| | | | |
|---------------|---|-------------------------|-------------|
| F01.10 | Auxiliary frequency source scope | Range: 0.00~1.00 | 1.00 |
|---------------|---|-------------------------|-------------|

This parameter cooperate with F01.09 define the scope of auxiliary provide frequency. Auxiliary provide frequency high limit value is restrained by the frequency selected by parameter F01.09 through parameter F01.10 gain calculation.

| | | | |
|---------------|------------------------------|--|----------------|
| F01.11 | Upper limit frequency | Range: lower limit frequency~600.00Hz | 50.00Hz |
|---------------|------------------------------|--|----------------|

This parameter's max setting frequency of all run modes should be modification carefully according to the motor nameplate details.

| | | | |
|---------------|---------------------------------------|--|---------------|
| F01.12 | Low limit frequency | Range: 0.00Hz~upper limit frequency | 0.40Hz |
| F01.13 | Low limit frequency run mode | Range : 0~3 | 2 |
| F01.14 | Sleep run hysteresis frequency | Range: 0.01Hz~upper limit frequency | 0.01Hz |

0: As low limit frequency run.

1: As setting frequency run.

2: As zero frequency run.

3: Sleep: PWM clocked at sleep mode.

When actual setting frequency lower than low limit frequency, low limit frequency run mode selection 0,then drive run at low limit frequency; low limit frequency run mode selection 1,drive continuously run according to setting frequency; low limit frequency run mode selection 2,drive continuously low output frequency and run at zero frequency; low limit frequency run mode selection 3,immediately clock the output and display frequency decline slowly to zero, when provide value over low limit frequency, drive restart to accelerate run from 0Hz to provide value after through F01.14 stagnant loop.



Note

When F01.13=3: this parameter can finish sleep function to achieve energy saving run and avoid drive to start frequently at threshold value through width of return difference.

| | | | |
|---------------|--------------------------------------|-------------------|----------|
| F01.15 | Run command channel selection | Range: 0~2 | 0 |
|---------------|--------------------------------------|-------------------|----------|

0: Operation keyboard run control. Start and stop with

1: Terminal run command control. Terminal X1 is forward (FWD),X2 is reverse(REV)during the function code X1~X8 setup. Other terminal can also be regarded as for/rev input terminal.

2: Communication runs command control. Start and stop with communication mode.



1. Drive can change run command channel through switch of multi-function key, terminal command channel in halt and run, carefully modify command channel after confirm in site the permission to run command channel modification. After the command channel modification: keyboard  button setup valid or not by parameter F00.15.

2. After run command channel modification, frequency channel can be defined by parameter F18.00, F18.01, F18.02 or defined by parameter F01.00, F01.03, F01.06 and multi-function terminal.

| | | | |
|---------------|----------------------------|---|-------------|
| F01.16 | Run direction setup | Range: units digit: 0,1 tens digit: 0~2 hundreds digit: 0、1 thousands digit: 0、1 | 1000 |
|---------------|----------------------------|---|-------------|

Units digit: Keyboard command for/rev setup (only valid to keyboard inching command)

0: Forward.

1: Reverse.

Tens digit: for/rev forbid (suitable for all command channel, not include inching function)

0: For/rev available.

1: Reverse not available (imposing on reverse, stop as the halt mode).

2: Forward not available (imposing on forward, stop as the halt mode).

Hundreds digit: Reverse running direction (only valid for keyboard and communication channel)

0: invalid

1: valid. It can achieve the adjustment of the motor running direction without adjusting the UVW wiring sequence.

Note: Under the condition that realize multi-section speed control by the PLC or terminal, if the tens of F10.01 to F10.15 is equal to 0 or 1, the direction of motor running is not affected by this parameter.

Thousands digit: Terminal multi-section speed acceleration and deceleration time control

0: Respectively, corresponding to acceleration and deceleration 1 to 15

1: Determined by F01.17 and F01.18

| | | | |
|---------------|----------------------------|----------------|----------------|
| F01.17 | Acceleration time 1 | Range: 1~60000 | Depend on type |
|---------------|----------------------------|----------------|----------------|

| | | | |
|---------------|----------------------------|----------------------|-----------------------|
| F01.18 | Deceleration time 1 | Range:1~60000 | Depend on type |
|---------------|----------------------------|----------------------|-----------------------|

Acceleration time is interval accelerate from zero frequency to high limit frequency, deceleration time is the interval decelerate from high limit frequency to zero frequency. The unit defined by F01.19. Example: F01.17=100, F01.19=1, acceleration time 1 is 10.0 seconds.



Note

- 1.EN500/EN600 series drive defines 15 acceleration and deceleration time, only acceleration and deceleration time 1 defined here, acceleration and deceleration 2~15 defined in parameter F04.16~F04.43.
- 2.acceleration and deceleration 1~15 select time unit through parameter F1.19,factory default unit is 0.1 second.

| | | | |
|---------------|--|-------------------|----------|
| F01.19 | Accelerate/decelerate time unit | Range: 0~2 | 1 |
|---------------|--|-------------------|----------|

This function can define acceleration and deceleration time unit.

- 0:0.01s
- 1:0.1s
- 2:1s



Note

- 1.The function is valid to all acceleration and deceleration except for inching run.
- 2.Advise to select 0.1s as the time unit.

| | | | |
|---------------|---|--------------------|----------|
| F01.20 | Accelerate/decelerate mode selection | Range: 0, 1 | 0 |
|---------------|---|--------------------|----------|

0:Line acc/dece mode. Output frequency raises or decline as the constant slope, as fig.7-1.

1: S curve acc/dece mode. Output frequency raise or decline as the S curve: as fig.7-2.

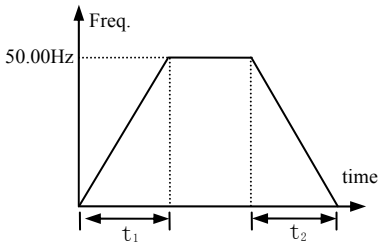

Fig. 7-1 Line acc/dece

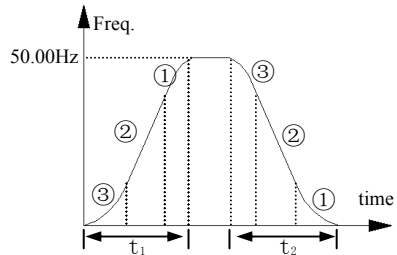

Fig. 7-2 S curve acc/dece

| | | | |
|---------------|---|---------------------------|--------------|
| F01.21 | S curve acceleration initiation segment time | Range: 10.0%~50.0% | 20.0% |
| F01.22 | S curve acceleration up segment time | Range: 10.0%~70.0% | 60.0% |
| F01.23 | S curve deceleration initiation segment time | Range: 10.0%~50.0% | 20.0% |
| F01.24 | S curve deceleration up segment time | Range: 10.0%~70.0% | 60.0% |

F01.21~F01.24 select S curve acceleration and deceleration mode(F01.20=1)valid only under acceleration and deceleration, and $F01.21+F01.22 \leq 90\%$, $F01.23+F01.24 \leq 90\%$.

S curve starts interval time as fig.7-2③, output frequency changed slope increase slowly from zero.

S curve up interval time as fig.7-2②, output frequency changed slope is constant.

S curve ends interval time as fig.7-2①, output frequency changed slope decrease slowly to zero.



Note

S curve acc/dece mode is suitable for the start and stop of elevator, conveyor belt, transport and transfer load so on.

| | | | |
|---------------|-----------------------------------|---|---------------|
| F01.25 | Keyboard jog run frequency | Range:0.00Hz~upper limit frequency | 5.00Hz |
| F01.26 | Terminal jog run frequency | Range:0.00Hz~upper limit frequency | 5.00Hz |
| F01.27 | Jog interval time | Range: 0.0~100.0s | 0.0s |
| F01.28 | Jog acceleration time | Range: 0.1~6000.0s | 20.0s |
| F01.29 | Jog deceleration time | Range: 0.1~6000.0s | 20.0s |

F01.25, F1.26 defines keyboard jog and terminal jog run frequency, when jog run: accelerate as the zero frequency, and not effect by the start mode defined by parameter F02.00. When jog command revocation, stop as setting halt mode, when input another command during the deceleration, accelerate or decelerate according to the current frequency.

F1.27 defies valid command interval time at continuously jog. When jog command invalid, the time restart jog command is short than jog interval time, jog command ignore here.

F1.28, F1.29 defines jog run acceleration and deceleration time, fixed unit is 1s.

7.3 Start, stop, forward/reverse, brake function parameter group: F02

| | | | |
|--------|--------------------|------------|---|
| F02.00 | Start running mode | Range: 0~2 | 0 |
|--------|--------------------|------------|---|

0: Start from starting frequency. After receiving start command by setting F02.01 delay time, the inverter starts after setting F02.02 starting frequency and F02.03 starting frequency duration.

1: First brake, and then start from starting frequency. First brake the current from DC and then from time (F02.04, F02.05), and then start after setting starting frequency and starting frequency duration set by F02.03.

2: Speed tracking start. This mode can be supported by the entire motor control model at the present.



Note

1. Start-up mode 0: It is suggested to use Start-up mode 0 for general purpose applications and for general drive synchronous motor.
2. Start-up mode 1: Suitable for small inertia load, for example, forward and reverse occurs when the motor is not driven.
3. Start-up mode 2: Suitable for the starting of large inertia load before stopping stably. Generally this mode is used when restarting after power failure, fault self-recovery and other functions. The following points need to be noticed when this Start-up mode is used:
 - 3.1 When the inverter stops freely, restart the inverter after a few seconds. If over-current fault occurs when starting, please extend the F02.08 time.
 - 3.2 Do not modify the set frequency when the inverter starts in slow down process.
4. When torque model is valid, we suggest use the start mode 2.

| | | | |
|--------|---------------------|------------------|------|
| F02.01 | Starting delay time | Range: 0.0~60.0s | 0.0s |
|--------|---------------------|------------------|------|

Starting delay time refers to the waiting time before the inverter is started after receiving running command.

| | | | |
|--------|----------------------------------|--------------------|--------|
| F02.02 | Starting frequency | Range: 0.0~10.00Hz | 0.00Hz |
| F02.03 | Starting frequency duration time | Range: 0.0~60.0s | 0.0s |

Starting frequency refers to the initial frequency when the inverter is started, as shown in Fig. 7-3 fs; starting frequency holding time refers to consecutive running time during which the inverter runs at the starting frequency, as shown in Fig. 7-3 t_f.

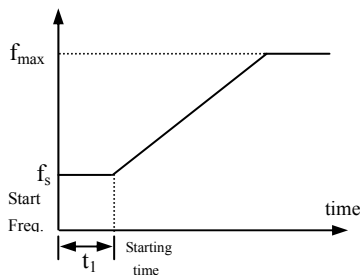

Fig. 7-3 Starting frequency and starting time



Note

Starting frequency is not limited by lower limit frequency.

| | | | |
|--------|----------------------------------|--|-------|
| F02.04 | DC braking current when starting | Range: 0.0 ~ 100.0% (G type inverter rated current) | 30.0% |
| F02.05 | DC braking time when starting | Range: 0.0 ~ 30.0s | 0.0s |

When F02.00=1, F02.04, F02.05 valid, and stop mode is deceleration stop, as shown in Fig. 7-4.

The setting of starting DC braking current is with respect to the percentage of inverter rated output current. When starting DC braking time is 0.0 second, no DC braking process.

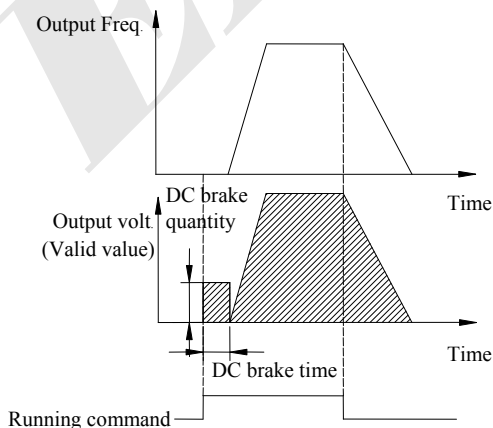

Fig. 7-4 Starting mode 1 description

| | | | |
|---------------|---|-------------------|----------|
| F02.06 | Speed track starting frequency selection | Range: 0~2 | 2 |
|---------------|---|-------------------|----------|

0: Current setting frequency.

1: Running frequency before power down.

2: Speed track auxiliary starting frequency.

Select frequency closed to the current running frequency of the motor so as to track the current running revolving speed of the motor. For example, when current running frequency is closed to current setting frequency, then select 0 and start to search from current setting frequency.

| | | | |
|---------------|---|---|----------------|
| F02.07 | Speed track auxiliary starting frequency | Range:0.00Hz~upper limit frequency | 30.00Hz |
|---------------|---|---|----------------|

This parameter defines when 2 is selected in F02.06 parameter, the starting searching frequency when revolving track is started.

| | | | |
|---------------|--|---------------------------|--------------|
| F02.08 | Speed track starting waiting time | Range: 0.00~10.00s | 0.10s |
|---------------|--|---------------------------|--------------|

When 2 is selected in F02.00, if the inverter checks that the running command is valid, the revolving speed is searched after the time defined by F2.08.

| | | | |
|---------------|--|--------------------|----------|
| F02.09 | Speed track current control coefficient | Range: 1~20 | 2 |
|---------------|--|--------------------|----------|

This parameter define the speed search process tracking current, the bigger of the value , the faster it can track.

| | | | |
|---------------|---|------------------------|-------------|
| F02.10 | Speed track searching speed time | Range: 0.1~30.0 | 4.00 |
|---------------|---|------------------------|-------------|

This parameter can be modified to improve speed track time.

On SVC control, the minimum unit of speed tracking for search speed time is 0.1s;

On V/F control, the minimum unit of speed tracking for search speed time is 1s;



Note

1. F02.06~F02.09 parameter only can be started on the speed variator, the start is valid.

2.F02.10 parameter can be used for both V/F model and SVC model .

| | | | |
|---------------|------------------|-------------------|----------|
| F02.11 | Stop mode | Range: 0~2 | 0 |
|---------------|------------------|-------------------|----------|

0: Deceleration stop. After receiving stop command, the inverter reduces output frequency gradually according to the set deceleration time, the inverter stops when frequency is 0.

1: Free stop. After receiving stop command, the inverter stops output

immediately, and the load stops freely according to mechanical inertia.

2: Deceleration + DC braking stop. After receiving stop command, the inverter reduces output frequency gradually according to the set deceleration time. When reaching F02.14 starting frequency of stop braking, After F02.15 defines DC braking waiting time, the inverter starts DC braking, as shown in Fig. 7-5.

| | | | |
|---------------|--|---|---------------|
| F02.12 | Deceleration stop holding frequency | Range: 0.00Hz~upper limiting frequency | 0.00Hz |
| F02.13 | Deceleration stop holding time | Range: 0.00~10.00s | 0.00s |

The parameters F02.12 and F02.13 define inverter's deceleration stop holding function. When the frequency reaches set value of F02.12 in deceleration, it stops deceleration, and maintains the set time of F02.13, and enters deceleration state. This parameter is only valid for stop mode 0.

| | | | |
|---------------|---|---|---------------|
| F02.14 | Stop DC braking starting frequency | Range: 0.00~15.00Hz | 0.50Hz |
| F02.15 | Sop DC braking waiting time | Range:0.00~30.00s | 0.00s |
| F02.16 | Stop DC braking current | Range: 0.0~100.0% (G type machine rated current) | 0.0% |
| F02.17 | Stop DC braking time | Range: 0.0~30.0s | 0.0s |
| F02.18 | Stop auxiliary braking current | Range: 0.0~100.0% (G type machine rated current) | 0.0% |
| F02.19 | Stop auxiliary braking time | Range: 0.0~100.0s | 0.0s |

F02.14 ~ F02.19 parameter defines the current and duration inputting to the motor in the stop DC braking state. If F02.17, F02.19 or F02.14 parameter is 0.0s, then no DC braking process.

Auxiliary DC brake means when the inverter stops DC brake is finished give the second stage DC braking. Role in some special circumstances require rapid braking, and stop long time in the state of DC braking, but to prevent motor heat circumstances.

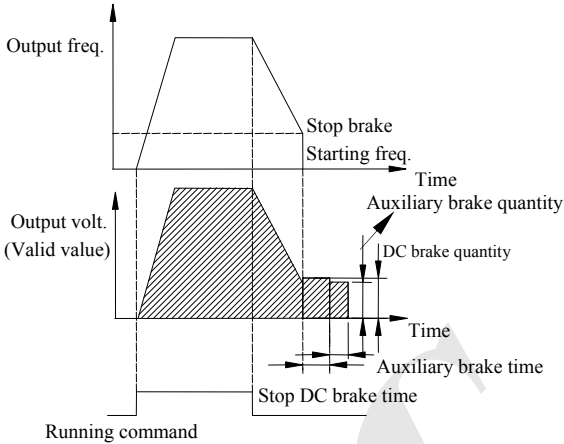

Fig. 7-5 Deceleration stop + DC braking

| | | | |
|---------------|---------------------------------------|--------------------------|-------------|
| F02.20 | Forward/reverse dead zone time | Range:0.0~3600.0s | 0.0s |
| F02.21 | Forward/reverse switching mode | Range: 0, 1 | 0 |

0: Over zero switchover

1: Over starting frequency switchover

Forward/reverse dead zone time refers to the process in which the inverter operates from forward to reverse or from reverse to forward. After output frequency reaches the defined frequency in switchover mode, entering in to the transition time, as shown in Fig. 7-6 t_1 , within transition time t_1 , output frequency is 0Hz.

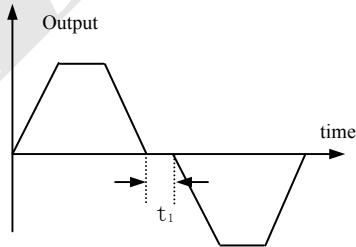

Fig. 7-6 Forward/reverse dead zone time

| | | | |
|---------------|---|-------------------|----------|
| F02.22 | Energy consumption braking selection | Range: 0~2 | 0 |
|---------------|---|-------------------|----------|

0: No energy consumption braking.

1: Energy consumption braking 1(No braking while halting).

2: Energy consumption braking 2(Braking while halting). This option can prevent over-voltage fault caused by high busbar voltage during the halting process.



Note

Please set the function parameter correctly according to the actual use condition. Otherwise, control feature will be affected. Before starting this function, make sure the inverter has built-in brake unit and brake resistor.

| | | | |
|---------------|--|---|---------------|
| F02.23 | Energy consumption braking voltage | Range:100.0~145.0% (rated busbar voltage) | 125.0% |
| F02.24 | Energy consumption braking use rate | Range:0.0~100.0% | 100.0% |

Energy consumption braking function is only valid for built-in brake unit. F02.23 defines energy consumption braking busbar voltage threshold value, F02.24 parameter adjusts duty ratio brake unit. The higher the brake use rate is, the greater the brake unit duty ratio is, and the more apparent the brake effect is, but when fluctuation of the brake process busbar voltage is more apparent, user needs to select proper parameter based on brake resistor and brake power.

| | | | |
|---------------|------------------------|-----------------------|----------|
| F02.25 | Encryption time | Range:0~65535h | 0 |
|---------------|------------------------|-----------------------|----------|

When F02.25>1, the encryption time is valid .When the running time (F05.38) exceed the time defined by F02.25, the inverter will stop and the keyboard display A-53, the inverter can only start again after decode.

| | | | |
|---------------|-----------------------------------|--|-----------|
| F02.26 | Over debugging coefficient | Range:95%~115% (only when F00.24=1 valid) | 1% |
|---------------|-----------------------------------|--|-----------|

Under field-weaken (only when F00.24=1 valid), properly to boost this parameter to decrease the output current, while the parameter value too big will increase the harmonic wave of output current.

7.4 V/F control parameter group: F03

| | | | |
|---------------|----------------------|-------------------|----------|
| F03.00 | V/F curve set | Range: 0~5 | 0 |
|---------------|----------------------|-------------------|----------|

0: Constant torque curve.

1: Degression torque curve 1.

2: Degression torque curve 2.

3: Degression torque curve 3.

4: V/F curve setting (V/F frequency and voltage cannot be 0 or Max. value).

5: V/F Separation control (voltage channel is determined by F18.22). Torque motor, inverter power supply, induction heating can use this control method.

This function code defines EN500/EN600 flexible V/F setting mode to satisfy different load characteristics. 4 kinds of fixed curves and one customized curve can be selected according to definition of F03.00.

When F3.00=0, V/F curve is Constant torque curve feature, as shown in Fig. 7-7a curve 0.

When F03.00=1, V/F curve is 2.0 order power degressive torque characteristic, as shown in Fig. 7-7a curve 3.

When F03.00=2, V/F curve is 1.7 order power degressive torque characteristic, as shown in Fig. 7-7a curve 2.

When F03.00=3, V/F curve is 1.2 order power degressive torque characteristic, as shown in Fig. 7-7a curve 1.

User can choose 1, 2, 3 V/F curve running mode according to load characteristic to reach better energy-saving effect when the inverter drives degressive torque load such as blower and water pump etc.

When F03.00=4, user can set V/F curve by setting F03.04 ~ F03.11 parameter.

As shown in Fig. 7-7b, V/F curve can be defined freely by setting (V1, F1), (V2, F2), (V3, F3), (V4, F4) to meet special load environment.

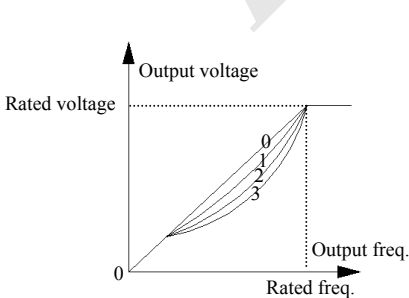
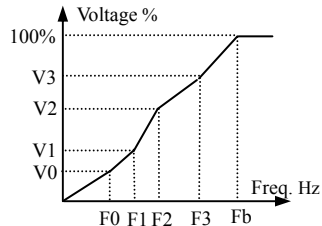

Fig. 7-7 a V/F curve



V0~V3: The 1st-4th voltage percentage of multi section V/F
 F0~F3: The 1st-4th frequency points of multi section V/F
 Fb: Rated frequency

b User-setting V/F curve

| | | | |
|---------------|--------------------------|--------------------|----------|
| F03.01 | Torque boost mode | Range: 0, 1 | 0 |
|---------------|--------------------------|--------------------|----------|

0: Manual boost. Torque boost voltage is totally decided by parameter F03.02, whose feature is that the boost voltage is fixed, but magnetic saturation of the motor is occurs often to the light-load.

$$\text{Boost voltage} = \frac{\text{F03.02}}{100} \times \text{motor rated voltage}$$

1: Auto torque boost. Torque boost voltage changes when the stator current of the motor changes, the greater the stator current is, magnetic saturation boost voltage is.

$$\text{Boost voltage} = \frac{\text{F03.02}}{100} \times \text{motor rated voltage} \times \frac{\text{Inverter output current}}{2 \times \text{inverter rated current}}$$

| | | | |
|---------------|---------------------------------------|--|-----------------------|
| F03.02 | Torque boost | Range: 0.0~12.0% | Depend on type |
| F03.03 | Torque boost cut-off frequency | Range:0.0~100.0% (motor rated frequency) | 100.0% |

Improving inverter low torque characteristic, the output voltage can be compensated

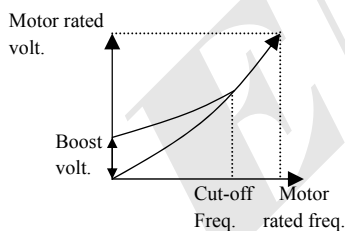

a Degression torque curve Torque boost

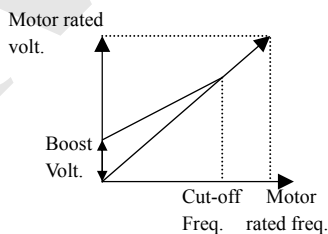

b Constant torque curve Torque boost

Fig. 7-8 Torque boost



Note

- 1.F03.02 for increasing torque setting to this parameter can cause motor heating or over current protection.
- 2.When driving synchronous machine ,User is advised to adopt manual torque boost and adjust V/F curve according to motor parameter and usage occasion when driving synchronous motor.

| | | | |
|---------------|------------------------------|---|----------------|
| F03.04 | V/F frequency value 0 | Range: 0.00~V/F frequency value1 | 10.00Hz |
|---------------|------------------------------|---|----------------|

| | | | |
|--------|----------------------|--|---------|
| F03.05 | V/F voltage value 0 | Range:0.00~V/F voltage value1 | 20.00% |
| F03.06 | V/F frequency value1 | Range: V/F frequency value 0~V/F frequency value2 | 20.00Hz |
| F03.07 | V/F voltage value1 | Range: V/F voltage value0~V/F voltage value2 | 40.00% |
| F03.08 | V/F frequency value2 | Range: V/F frequency value1~V/F frequency value3 | 25.00Hz |
| F03.09 | V/F voltage value2 | Range: V/F voltage value1~V/F voltage value3 | 50.00% |
| F03.10 | V/F frequency value3 | Range: V/F frequency value2~upper limiting frequency | 40.00Hz |
| F03.11 | V/F voltage value3 | Range: V/F voltage value2~100.00%(motor rated voltage) | 80.00% |

F03.04 ~ F03.11 defines multi-step V/F curve. Note that 4 voltage points and frequency points relationship shall be satisfied: $V_0 < V_1 < V_2 < V_3$, $F_0 < F_1 < F_2 < F_3$, for details, please refer to Fig. 7-8b.

If the voltage at low frequency is set too high, motor overheat or even over burning may cause, over current protection may occur to the inverter.

| | | | |
|--------|------------------------------------|--------------|----|
| F03.12 | V/F oscillation suppression factor | Range: 0~255 | 10 |
|--------|------------------------------------|--------------|----|

Under V/F control, this parameter can be set properly to prevent motor vibration of the motor. When the inverter operates at low frequency without load, the greater the motor power is, the greater the vibration of motor will be. This parameter can be increased to restrain the vibration of motor. When carrier freq. is smaller, this parameter can be adjusted lower to reduce vibration.

7.5 Auxiliary running parameter group: F04

| | | | |
|--------|--------------------|--|--------|
| F04.00 | Jump freq. 1 | Range: 0.00Hz~upper limiting frequency | 0.00Hz |
| F04.01 | Jump freq. 1 range | Range: 0.00Hz~upper limiting frequency | 0.00Hz |
| F04.02 | Jump freq. 2 | Range: 0.00Hz~upper limiting frequency | 0.00Hz |
| F04.03 | Jump freq. 2 range | Range: 0.00Hz~upper limiting frequency | 0.00Hz |
| F04.04 | Jump freq. 3 | Range: 0.00Hz~upper limiting frequency | 0.00Hz |
| F04.05 | Jump freq. 3 range | Range: 0.00Hz~upper limiting frequency | 0.00Hz |

F04.00 ~ F04.05 is set to keep inverter's output frequency away from resonance frequency of mechanical load. Inverter setting frequency can jump around some

frequency point according to mode as shown in Fig. 7-9, 3 jumping ranges can be defined at most.

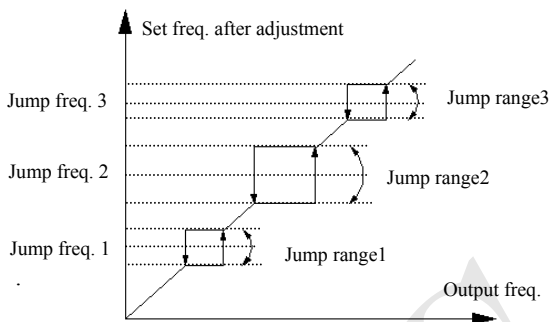

Fig. 7-9 Jump freq. and range

| | | | |
|---------------|--|--------------------------|---------------|
| F04.06 | Slip freq. gain | Range: 0.0~300.0% | 0.0% |
| F04.07 | Slip compensation limit | Range: 0.0~250.0% | 100.0% |
| F04.08 | Slip compensation time constant | Range: 0.1~25.0s | 2.0s |

This function can adjust output frequency properly as the load varies to compensate slip frequency of the asynchronous motor dynamically, so that control motor speed is in constant value. If acting with automatic torque boost function, better low speed moment characteristic can be obtained. As shown in Fig.7-10.

Slip compensation range = Slip compensation limit (F04.06)× Rated slip .

Rated slip = $F15.03 \times 60 / N_p - F15.04$.

N_p is motor polarity.

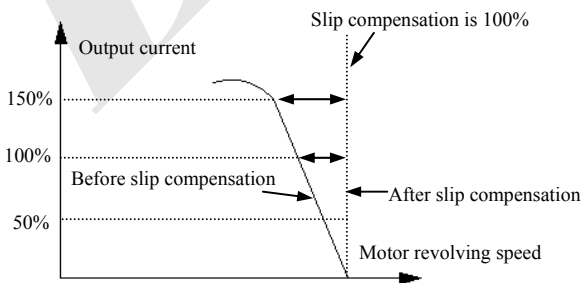

Fig. 7-10 Slip freq. Compensation

| | | | |
|---------------|--------------------------|-------------------------|-----------------------|
| F04.09 | Carrier frequency | Range: 0.5~16.0K | Depend on type |
|---------------|--------------------------|-------------------------|-----------------------|

Carrier freq. mainly affects motor noise and heat loss when running. Relationship among carrier freq, motor noise, and leak current is as follows:

When carrier freq. goes up (↑), the motor noise is reduced (↓), leakage current of the motor is increased (↑), and the interference is increased (↑);

When carrier freq. goes down (↓), the motor noise is increased (↑), leakage current of the motor is decreased (↓), and the interference is decreased (↓).

When the ambient temperature is high, and the motor load is heavy, reduce the carrier freq. properly to reduce thermal loss to the inverter.

Table7-1 model and Carrier freq. relationship

| Model | Max. Carrier freq. | Factory Default |
|-------------|--------------------|-----------------|
| 0.4KW~1.5KW | 16KHz | 6KHz |
| 2.2KW~11KW | 16KHz | 5KHz |
| 15KW~55KW | 8KHz | 4KHz |
| 75~200KW | 6KHz | 2KHz |
| 220KW above | 4KHz | 2KHz |



Note

- 1.To get better control characteristic, it is suggested that the ratio of max. running frequency between carrier frequency and inverter be not smaller than 36.
- 2.Error exists in current displayed value when carrier frequency is small.

| | | | |
|---------------|---------------------------------|---|-------------|
| F04.10 | PWM optimized adjustment | Range: units digit: 0,1 tens digit: 0,1 hundreds digit: 0,1 thousands digit: 0,1 | 0010 |
|---------------|---------------------------------|---|-------------|

Units digit: Carrier freq. is adjusted automatically according to temperature

0: Banned.

1: Allowed.

Carrier frequency changes based on temperature, which refers to inverter check that the radiator temperature is relatively high, it automatically reduces carrier freq., so as to reduce inverter temperature rise. When radiator temperature is relatively low, carrier freq. gradually restores to set value. This function can reduce inverter overheat alarm.

Digit: low speed carrier freq. limit mode

0: No limit.

1: Limit. Limit carrier wave at low speed, improve stability performance of revolving speed at low speed.

Hundreds digit: carrier wave modulation system

0: 3 phase modulation.

1: 2 phase and 3 phase modulation.

Thousands digit: Asynchronous modulation, synchronization mode (valid under V/F control)

0: Asynchronous modulation.

1: Synchronous modulation (under 85Hz: Asynchronous modulation).



Note

1. When units digit is set as 1, after reaching overheat warning alarm point, carrier wave will decrease to 1.5KHz; when the temperature decrease to 5°C lower than overheat warning alarm point, carrier freq. will automatically rise to the set carrier freq.
 2. Synchronous modulation, it means that carrier freq. changes when output frequency changes, it guarantees that the ratio (carrier ratio) between the two does not change, generally used when output frequency is high, conducive to input voltage quality. When output frequency is low (85Hz or below, generally no need of synchronous modulation), so at this time carrier freq. and output frequency ratio is relatively high, advantages of asynchronous modulation are more apparent. When operating frequency is higher than 85Hz, Synchronous modulation is valid, frequency lower than this is fixed with asynchronous modulation mode.

| | | | |
|---------------|---------------------|--------------------|----------|
| F04.11 | AVR function | Range : 0~2 | 2 |
|---------------|---------------------|--------------------|----------|

AVR namely automatic voltage regulation function, it indicates that the inverter can output constant voltage by AVR function when the inverter inputs voltage fluctuates.

0: No action

1: Action all the time

2: No action only during deceleration



Note

1. When input voltage is higher than rated value, under normal situation, F04.11=1 shall be set. F02.11= 0 namely inverter is in deceleration stop, motor deceleration time short time running current will be greater. But the motor decrease speed placidly with small run current and long Dec time if choose AVR action all the time.
 2. When motor system vibration occurs due to AVR function, set F04.11= 0, namely AVR function is invalid.
 3. This function is valid in V/F control mode.

| | | | |
|--------|----------|--|--|
| F04.12 | Reserved | | |
|--------|----------|--|--|

| | | | |
|--------|-----------------------------------|-------------|---|
| F04.13 | Automatic energy saving operation | Range: 0, 1 | 0 |
|--------|-----------------------------------|-------------|---|

0: No action

1: Action

To reach better energy-saving effect, automatic energy-saving purpose can be obtained by checking load current.

When motor runs with no-load or light-load, energy-saving can be realized by checking load current, and properly adjusting input voltage. Auto energy-saving operation is mainly used in applications like stable load and revolving speed.



Note

1. This function is generally used in load like blower and water pump.
2. This function is valid only in V/F mode.

| | | | |
|--------|--|-------------------------------------|--------|
| F04.14 | Acceleration time 2 and 1 switchover frequency | Range: 0.00Hz~upper limit frequency | 0.00Hz |
| F04.15 | Deceleration time 2 and 1 switchover frequency | Range: 0.00Hz~upper limit frequency | 0.00Hz |

This function is used in the process of the inverter running, and we should adopted the acceleration time and deceleration for different applications.

During the acceleration process, if the frequency is lower than F04.14, we choose acceleration time 2, if the running frequency is bigger than F04.14, we choose acceleration time 1, during the deceleration process, if the running frequency is bigger than F04.15, then we choose deceleration time 1, if the running frequency is lower than F14.05, then we choose deceleration time 2.



Note

When using terminal for choose the deceleration time, F04.14, F04.15 function is invalid.

| | | | |
|--------|---------------------|----------------|-----|
| F04.16 | Acceleration time 2 | Range: 1~60000 | 200 |
| F04.17 | Deceleration time 2 | Range: 1~60000 | 200 |
| F04.18 | Acceleration time 3 | Range: 1~60000 | 200 |
| F04.19 | Deceleration time 3 | Range: 1~60000 | 200 |
| F04.20 | Acceleration time 4 | Range: 1~60000 | 200 |
| F04.21 | Deceleration time 4 | Range: 1~60000 | 200 |

| | | | |
|---------------|-----------------------------|-----------------------|------------|
| F04.22 | Acceleration time 5 | Range: 1~60000 | 200 |
| F04.23 | Deceleration time 5 | Range: 1~60000 | 200 |
| F04.24 | Acceleration time 6 | Range: 1~60000 | 200 |
| F04.25 | Deceleration time 6 | Range: 1~60000 | 200 |
| F04.26 | Acceleration time 7 | Range: 1~60000 | 200 |
| F04.27 | Deceleration time 7 | Range: 1~60000 | 200 |
| F04.28 | Acceleration time 8 | Range: 1~60000 | 200 |
| F04.29 | Deceleration time 8 | Range: 1~60000 | 200 |
| F04.30 | Acceleration time 9 | Range: 1~60000 | 200 |
| F04.31 | Deceleration time 9 | Range: 1~60000 | 200 |
| F04.32 | Acceleration time 10 | Range: 1~60000 | 200 |
| F04.33 | Deceleration time 10 | Range: 1~60000 | 200 |
| F04.34 | Acceleration time 11 | Range: 1~60000 | 200 |
| F04.35 | Deceleration time 11 | Range: 1~60000 | 200 |
| F04.36 | Acceleration time 12 | Range: 1~60000 | 200 |
| F04.37 | Deceleration time 12 | Range: 1~60000 | 200 |
| F04.38 | Acceleration time 13 | Range: 1~60000 | 200 |
| F04.39 | Deceleration time 13 | Range: 1~60000 | 200 |
| F04.40 | Acceleration time 14 | Range: 1~60000 | 200 |
| F04.41 | Deceleration time 14 | Range: 1~60000 | 200 |
| F04.42 | Acceleration time 15 | Range: 1~60000 | 200 |
| F04.43 | Deceleration time 15 | Range: 1~60000 | 200 |

EN500/EN600 defines 15 kinds of acceleration/deceleration time, select acceleration/deceleration time 1 ~ 15 during the inverter running by different combinations of control terminal. Please refer to the definitions of acceleration/deceleration time terminal function in F08.18 ~ F08.25. Cooperating with simple PLC function can also realize each step of PLC adopting different acceleration/deceleration time to complete specific requirements.

The time unit of acceleration/deceleration time 2 ~ 15 above is the same as that of acceleration/deceleration time 1, all are decided by F01.19 parameter of acceleration/deceleration time unit.



Note

Acceleration/deceleration time 1 is defined in F01.17 and F01.18.

7.6 Communication control parameter group: F05

| | | | |
|---------------|---------------------------|-------------------|----------|
| F05.00 | Protocol selection | Range: 0~6 | 0 |
|---------------|---------------------------|-------------------|----------|

0: Modbus protocol .

1: Reserved.

2: Profibus protocol, external expansion card needs to be purchased if needed.

3: CANlink protocol, external expansion card needs to be purchased if needed.

4: CANopen protocol, external expansion card needs to be purchased if needed.

5: Free protocol 1. Can realize the revision of all EN500/EN600 function parameters

6: Free protocol 2. Can only realize the revision of part EN500/EN600 function parameters

| | | | |
|---------------|--------------------------------|---|------------|
| F05.01 | Baud rate configuration | Range: units digit: 0~9 tens digit: Reserved hundreds digit: 0~6 | 005 |
|---------------|--------------------------------|---|------------|

F05.01 is for choosing communication baud rate when using different communication modules.

Units digit: Free protocol and Modbus Baud rate selection

0:300BPS

1:600BPS

2:1200BPS

3:2400BPS

4:4800BPS

5:9600BPS

6:19200BPS

7:38400BPS

8:57600BPS

9: 115200BPS

Tens digit: Reserved

Hundreds digit: CanLink and CANopen Baud rate selection

0:20K

1:50K
2:100K
3:125K
4:250K
5:500K
6:1M

| | | | |
|---------------|--------------------|---|-------------|
| F05.02 | Data format | Range: units digit:0~5 tens digit :0~3 hundreds digit: 0~2 thousands digit: 0、 1 | 0000 |
|---------------|--------------------|---|-------------|

Units digit: Free protocol and Modbus protocol data format

0: 1-8-1 format, no parity, RTU. 1 for start bit, 8 for data bits, 1 for stop bit, no parity's RTU communication mode.

1: 1-8-1 format, even parity, RTU. 1 for start bit, 8 for data bits, 1 for stop bit, even parity's RTU communication mode.

2: 1-8-1 format, odd parity, RTU. 1 for start bit, 8 for data bits, 1 for stop bit, odd parity's RTU communication mode.

3: 1-7-1 format, no parity, ASCII. 1 for start bit, 7 data bits, 1 for stop bit, no parity's ASCII communication mode.

4: 1-7-1 format, even parity, ASCII. 1 for start bit, 7 data bits, 1 for stop bit, even parity's ASCII communication mode.

5: 1-7-1 format, odd parity, ASCII. 1 for start bit, 7 data bits, 1 for stop bit, odd parity's ASCII communication mode.

Tens digit: Profibus_DP protocol data format

0: PPO1communication format

1: PPO2communication format

2: PPO3communication format

3: PPO5communication format

Hundreds digit: Modbus agreement or free protocol response selection

Under the condition that Modbus or protocol agreement and the hundreds of F05.02 is 1, when slave sends mainframe the demand of running, frequency revise and hide parameter inside, the slave is without response to increase the slave response speed. But when mainframe reads inverter parameter, status or revises inverter any parameter, the hundreds of F05.02 would not influence the slave response. The read-only instruction will respond only when the hundreds of F05.02 is 2.

Thousands digit: Communication Sets power down reserve setup. If this bit = 1, the communication address like 1D00H, 1D01H, 1D02H, 1D03H, 1D06H,

1D0AH, 1D0BH will reserve when power-off , otherwise not reserved when power-off.

| | | | |
|---------------|----------------------|---------------------|----------|
| F05.03 | Local address | Range: 0~247 | 1 |
|---------------|----------------------|---------------------|----------|

During serial port communication, this function code is used to identify inverter's address.

Under free protocol communication, 00 is set and the inverter is master station, can be the Master-slave communication.

Under Modbus communication, 00 is broadcast address. When setting broadcast address, it can only receive and execute upper computer broadcast command, while cannot respond to upper computer.

| | | | |
|---------------|---|--------------------------|-------------|
| F05.04 | Communication overtime checkout time | Range:0.0~1000.0s | 0.0s |
|---------------|---|--------------------------|-------------|

When serial port communication fails and its continuous time exceed set value of this function code, the inverter judges it as communication failure.

The inverter would not detect serial port communication signal, namely this function ineffective when set value is 0.

| | | | |
|---------------|--|---------------------------|-------------|
| F05.05 | Communication error checkout time | Range: 0.0~1000.0s | 0.0s |
|---------------|--|---------------------------|-------------|

When serial port communication fails and its continuous time exceed set value of this function code, the inverter judges it as communication failure.

The inverter would not detect serial port communication signal, namely this function ineffective when set value is 0.

| | | | |
|---------------|----------------------------------|---|------------|
| F05.06 | Local response delay time | Range: 0~200ms (Modbus is valid) | 2ms |
|---------------|----------------------------------|---|------------|

Local response delay time represents the time within which the inverter serial port receives and executes command from upper device and then responds to upper device.

| | | | |
|---------------|---|----------------------|-------------|
| F05.07 | Main & sub inverter communication frequency setting percentage | Range: 0~500% | 100% |
|---------------|---|----------------------|-------------|

After setting this parameter proportion when frequency sent from main inverter, as the input source of communication frequency of sub inverter, one inverter can control multiple devices with different proportional frequency.



Note

This parameter is valid only when inverter is master slave station and the frequency given channel is communication given.

| | | | |
|---------------|---|----------------------|------------|
| F05.08 | Communication virtual input terminal enabled | Range: 00~FFH | 00H |
|---------------|---|----------------------|------------|

Bit0: CX1 virtual input terminal enabled

Bit1: CX2 virtual input terminal enabled

Bit2: CX3 virtual input terminal enabled

Bit3: CX4 virtual input terminal enabled

Bit4: CX5 virtual input terminal enabled

Bit5: CX6 virtual input terminal enabled

Bit6: CX7 virtual input terminal enabled

Bit7: CX8 virtual input terminal enabled

| | | | |
|---------------|--|-------------------|----------|
| F05.09 | Communication virtual input terminal joining node | Range: 0,1 | 0 |
|---------------|--|-------------------|----------|

0: Independent node. Communication virtual terminal function is only set in F05.10 ~ F05.17.

1: Terminal node. Communication virtual terminal function is only set in F08.18 ~ F08.25, regardless of X1 ~ X8 valid, or CX1 ~ CX8 valid all execute this setting function, X1 ~ X8 corresponds to CX1 ~ CX8.

| | | | |
|---------------|--|--------------------|----------|
| F05.10 | Communication virtual terminal CX1 function | Range: 0~90 | 0 |
| F05.11 | Communication virtual terminal CX2 function | Range: 0~90 | 0 |
| F05.12 | Communication virtual terminal CX3 function | Range: 0~90 | 0 |
| F05.13 | Communication virtual terminal CX4 function | Range: 0~90 | 0 |
| F05.14 | Communication virtual terminal CX5 function | Range: 0~90 | 0 |
| F05.15 | Communication virtual terminal CX6 function | Range: 0~90 | 0 |
| F05.16 | Communication virtual terminal CX7 function | Range: 0~90 | 0 |
| F05.17 | Communication virtual terminal CX8 function | Range: 0~90 | 0 |

Communication virtual terminal CX1 ~ CX8 function and terminal X1 ~ X8 function is different.



The communication virtual terminal function is realized by setting the Modbus address and 1D09

| | | | |
|--------|--|----------------------|-------|
| F05.18 | Input mapping application parameter 1 | Range: F00.00~F26.xx | 25.00 |
| F05.19 | Input mapping application parameter 2 | Range: F00.00~F26.xx | 25.00 |
| F05.20 | Input mapping application parameter 3 | Range: F00.00~F26.xx | 25.00 |
| F05.21 | Input mapping application parameter 4 | Range: F00.00~F26.xx | 25.00 |
| F05.22 | Input mapping application parameter 5 | Range: F00.00~F26.xx | 25.00 |
| F05.23 | Input mapping application parameter 6 | Range: F00.00~F26.xx | 25.00 |
| F05.24 | Input mapping application parameter 7 | Range: F00.00~F26.xx | 25.00 |
| F05.25 | Input mapping application parameter 8 | Range: F00.00~F26.xx | 25.00 |
| F05.26 | Input mapping application parameter 9 | Range: F00.00~F26.xx | 25.00 |
| F05.27 | Input mapping application parameter 10 | Range: F00.00~F26.xx | 25.00 |

Input parameter address mapping.

This parameter is used for mapping waiting for input. Integral part corresponds with group no. of the parameter, while decimal part corresponds with intra-class reference (parameter series no. within group parameter). For example: Setting F05.18=00.00 indicates that mapping F05.18=00.00 as input parameter 1.

1. xx represents function code.

2. F25.xx represents not mapping.

3. By this way, some incontinuity parameter can be together to read the data, and using the input mapping application parameter to increase the communication efficiency. For example, if reading F00.00, F01.10, F02.02 and F03.04, you can map the above-mentioned parameters to F05.18, F05.19, F05.20, F05.21 and F05.22. Under RTU communication mode, only 1 continuous reading 5 groups of parameter commands (01 03 05 12 00 05 24 D1) can read 5 groups of parameter values, thus improving communication efficiency.



Note

| | | | |
|--------|---|---|--|
| F05.28 | Setting frequency | Display current setting frequency | |
| F05.29 | Frequency after current acceleration / deceleration | Display the frequency after current acceleration / deceleration | |

| | | | |
|--------|---------------------------|--|--|
| F05.30 | Synchronous frequency | Display the current synchronous frequency | |
| F05.31 | Output current | Display the current output current | |
| F05.32 | Output voltage | Display the current output voltage | |
| F05.33 | DC busbar voltage | Displays the current DC busbar voltage | |
| F05.34 | Load motor speed | Display the current load motor speed | |
| F05.35 | Set torque | Display the current set torque(>37367, it is negative) | |
| F05.36 | Output torque | Display the current output torque (>32767, it is negative) | |
| F05.37 | Torque current | Display the current torque current | |
| F05.38 | Accumulated power-on time | Display the accumulated power-on time of the inverter | |
| F05.39 | Accumulated running time | Display the accumulated running time of the inverter | |

By reading the above parameters, it can realize the function of continuously reading a plurality of process parameters by communication. When the read value (F05.35 or F05.36) are greater than 32767, the actual value = the current value -65536, for example read value of F05.35 equals 65307, because 65307 > 32767, the actual value = 65307 - 65536 = -299, and the given torque is -29.9%.

7.7 Setting curve parameter group: F06

| | | | |
|--------|-------------------------|---|------|
| F06.00 | Setting curve selection | Range: units digit: 0~2 tens digit: 0~2 hundreds digit: 0~2 thousands digit: 0~2 | 0000 |
|--------|-------------------------|---|------|

Units digit: A11 curve selection

0: curve 1.

1: curve 2.

2: curve 3.

Tens digit: A12 curve selection

Same as units digit.

Hundreds digit: rapid pulse curve selection

Same as units digit.

Thousands digit: Pulse width setting curve selection

Same as units digit.

This function code tens digit, hundreds digit and thousands digit are used to select analog quantity input A11, A12, rapid pulse input and pulse width input signal

setting curve. Curve 1 and 2 are 3 point curve, curve 3 is 4 point curve. User can select different curves for adjustment based on characteristic requirement of the input signal so as to realize specific input.

| | | | |
|--------|--|---|--------|
| F06.01 | Curve 1 min. setting | Range: 0.0% ~ curve 1 Inflexion setting | 0.0% |
| F06.02 | Corresponding physical quantity of curve 1 min. setting | Range: 0.0 ~ 100.0% | 0.0% |
| F06.03 | Curve 1 inflexion setting | Range: curve 1 min. setting ~ curve 1 Max. setting | 50.0% |
| F06.04 | Corresponding physical quantity of curve 1 inflexion setting | Range: 0.0 ~ 100.0% | 50.0% |
| F06.05 | Curve 1 Max. setting | Range: curve 1 inflexion setting ~100.0% | 100.0% |
| F06.06 | Corresponding physical quantity of curve 1 Max. setting | Range: 0.0 ~ 100.0% | 100.0% |
| F06.07 | Curve 2 min. setting | Range: 0.0% ~ curve 2 inflexion setting | 0.0% |
| F06.08 | Corresponding physical quantity of curve 2 min. setting | Range: 0.0 ~ 100.0% | 0.0% |
| F06.09 | Curve 2 inflexion setting | Range: curve 2 min. setting ~ curve 2 Max. setting | 50.0% |
| F06.10 | Corresponding physical quantity of curve 2 inflexion setting | Range: 0.0 ~ 100.0% | 50.0% |
| F06.11 | Curve 2 Max. setting | Range: curve 2 inflexion setting ~ 100.0% | 100.0% |
| F06.12 | Corresponding physical quantity of curve 2 Max. setting | Range: 0.0 ~ 100.0% | 100.0% |
| F06.13 | Curve 3 min. setting | Range: 0.0% ~ curve 3 inflexion 1 setting | 0.0% |
| F06.14 | Corresponding physical quantity of curve 3 min. setting | Range: 0.0 ~ 100.0% | 0.0% |
| F06.15 | Curve 3 inflexion 1 setting | Range: curve 3 min. setting ~ curve 3 inflexion 2 setting | 30.0% |
| F06.16 | Corresponding physical quantity of curve 3 inflexion 1 setting | Range: 0.0 ~ 100.0% | 30.0% |
| F06.17 | Curve 3 inflexion 2 setting | Range: curve 3 inflexion 1 setting ~ curve 3 Max. setting | 60.0% |

| | | | |
|--------|--|--|--------|
| F06.18 | Corresponding physical quantity of curve 3 inflexion 2 setting | Range: 0.0 ~ 100.0% | 60.0% |
| F06.19 | Curve 3 Max. setting | Range: curve 3 inflexion 1 setting ~100.0% | 100.0% |
| F06.20 | Corresponding physical quantity of curve 3 Max. setting | Range: 0.0 ~ 100.0% | 100.0% |

Take curve 1 as an example:

Parameter F06.01 ~ F06.06 is used to set analog quantity input voltage and its representative set value relationship. When analog quantity input voltage is greater than the set “Max. input”(F06.05), analog quantity voltage is calculated based on “Max. input”; similarly, When analog input voltage is smaller than the set “min. input ”(F06.01), Set based on “ curve lower than min. input setting selection”(F06.21), calculated by min. input or 0.0%.



Note

1. For function and usage of curve 2, please refer to curve 1 instruction.
2. Curve 3 function is similar to curve 1 and curve 2, but curve 1 and 2 are three-point straight line, while curve 3 is four-point curve, which can realize more flexible corresponding relationship.
3. The output positive/negative polarity of curve 1, 2, 3 is decided by the features of input analog signal. Curve will not change output positive/negative polarity.
4. As frequency setting, 100.0% setting corresponding physical quantity is upper limit frequency F01.11.

| | | | |
|--------|---|---|-------|
| F06.21 | Curve lower than min. input corresponding selection | Range: units digit: 0,1 tens digit: 0,1 hundreds digit: 0,1 thousands digit: 0,1 ten thousands digit: 0,1 | 11111 |
|--------|---|---|-------|

Units digit: curve 1 setting

0: Corresponds to min. setting corresponding physical quantity.

1: 0.0% of the corresponding physical quantity.

Tens digit: curve 2 setting

Same as units digit.

Hundreds digit: curve 3 setting

Same as units digit.

Thousands digit: extended curve 1

Same as units digit.

Ten thousands digit: extended curve 2

Same as units digit.

This parameter is used to set, when curve's corresponding analog quantity input voltage is smaller than the min. setting, how to decide corresponding setting analog quantity.

For example, F06.21 units=0, when analog quantity input is lower than F06.01, this curve output F06.02 corresponding physical quantity value. If F06.21 units=1, when analog quantity input is lower than F06.01, this curve output is 0.

Take 0 ~ 10V AI1 for setting frequency as an example: AI1 selects curve 1, setting frequency and AI1 relationship as shown in Fig. 7-11.

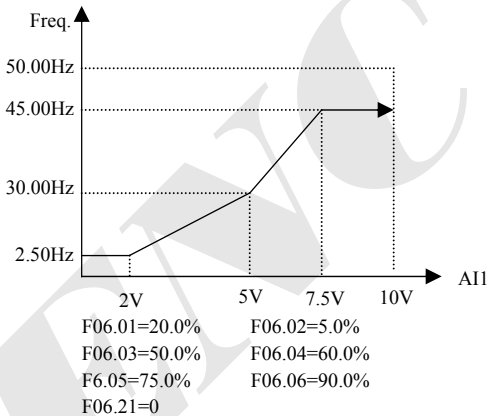

Fig. 7-11 AI1 selects curve 1 frequency setting

7.8 Analog quantity, Pulse input function parameter group: F07

| | | | |
|---------------|------------------------------|----------------------------|---------------|
| F07.00 | AI1 input filter time | Range: 0.000~9.999s | 0.050s |
| F07.01 | AI1 setting gain | Range: 0.000~9.999 | 1.006 |
| F07.02 | AI1 setting bias | Range: 0.0~100.0% | 0.5% |

AI1 input filter time, is used to set AI1 software filter time. When field analog quantity is easily interrupted, increase filter time to make the analog quantity check stable, but when filter time is greater, the response time of analog quantity check is slower. Please set according to the actual situation.

AI1 setting bias is indicated with Max. input (10V or 20mA) percentage, which is

used to set up and down translation quantity of AI1 analog input. Take voltage input, bias positive as an example, the adjustment relationship of setting bias and gain adjustment before and after adjustment is as follows:

Analog input AI1 (after revise) = input gain (F07.01) × Analog input AI1 (before revise) + setting bias (F07.02) × 10V

Taking current input and bias positive as an example, the adjustment relationship between gain adjustment and setting bias is as follows:

Analog input AI1 (after revise) = input gain (F07.01) × Analog input AI1 (before revise) + setting bias (F07.02) × 20mA

| | | | |
|---------------|------------------------------|----------------------------|---------------|
| F07.03 | AI2 input filter time | Range: 0.000~9.999s | 0.050s |
| F07.04 | AI2 setting gain | Range: 0.000~9.999 | 1.003 |
| F07.05 | AI2 setting bias | Range: 0.0~100.0% | 0.1% |

Parameter F07.03 ~ F7.05 is used to set analog quantity input AI2 filter time , gain and setting bias, For detail using method, please refer to analog quantity input AI1. Take voltage input, bias positive as an example, the adjustment relationship between gain adjustment and setting bias is as follows:

Analog input AI2 (after revise) = input gain (F07.04) × Analog input AI2 (before revise) + setting bias (F07.05) × 10V

Taking current input and bias positive as an example, the adjustment relationship between gain adjustment and setting bias is as follows:

Analog input AI2 (after revise) = input gain (F07.04) × Analog input AI2 (before revise) + setting bias (F07.05) × 20mA

| | | | |
|---------------|-------------------------------------|--|-----------|
| F07.06 | Analog setting bias polarity | Range: units digit: 0,1 tens digit: 0,1 | 01 |
|---------------|-------------------------------------|--|-----------|

Units digit: AI1 setting bias polarity

0: Positive polarity.

1: Negative polarity.

Tens digit: AI2 setting bias polarity

0: Positive polarity.

1: Negative polarity.

Parameter F07.06 is used to set analog quantity AI1 and when AI2 counts the polarity of bias. Take voltage input as an example, when F07.06 units are set as 0:

Analog input AI1(after revise) = input gain(F07.01)×Analog input AI1(before revise)+ Setting bias(F07.02)×10V

When F7.06 units are set as 1:

Analog input AI1(after revise) = input gain(F07.01)×Analog input AI1(before

revise)— Setting bias(F07.02) \times 10V

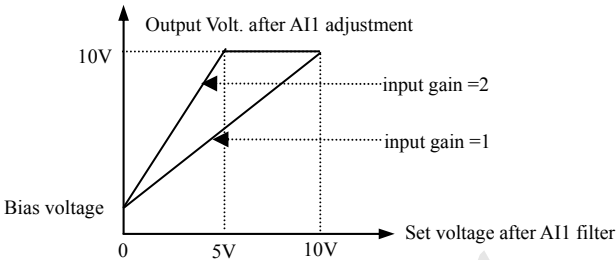

Fig. 7-12 A11 adjustment

| | | | |
|---------------|-----------------------------------|-----------------------------|-----------------|
| F07.07 | Pulse input filter time | Range: 0.000~9.999s | 0.000s |
| F07.08 | Pulse input gain | Range: 0.000~9.999 | 1.000 |
| F07.09 | Pulse input Max. frequency | Range: 0.01~50.00KHz | 10.00KHz |

F07.07, F07.08 parameter defines filter time and gain when frequency channel selection terminal pulse is set. When setting filter time, Please be noted that the longer the filter time is, the slower the change rate of output frequency is. So set filter time properly according to the actual situation. Pulse width gain is for impulse quantity of current input impulse terminal.

F7.09 parameter defines frequency input range when frequency setting channel selection terminal pulse is set. When actual input frequency is greater than the set Max. frequency, deal with it according to Max. frequency. When the external input pulse is less than 2Hz, disposed as 0Hz.

| | | | |
|---------------|--|----------------------------|----------------|
| F07.10 | Pulse width input filter time | Range: 0.000~9.999s | 0.000s |
| F07.11 | Pulse width input gain | Range: 0.000~9.999 | 1.000 |
| F07.12 | Pulse width input logic setting | Range: 0,1 | 0 |
| F07.13 | Pulse width Max. input width | Range: 0.1~999.9ms | 100.0ms |

F07.10, F07.11 parameter defines filter time and gain when frequency channel selection terminal pulse width is set. When setting filter time, Please be noted that when the Max. pulse width set in F07.13 is smaller, the filter time is not suggested to be set too long, otherwise the response time of output frequency will be very slow. Pulse width gain is for impulse width duty cycle of current impulse width input terminal

0: Positive logic.

1: Negative logic.

F07.12 defines valid level of digital quantity input X8 channel input pulse when frequency channel selection terminal pulse width is set. The applications shall go with double polarity working state of X input terminal.

F07.13 parameter defines the width range of input valid pulse when frequency setting channel selection terminal pulse width is set.

| | | | |
|---------------|---|---------------------------|--------------|
| F07.14 | Analog input disconnection detection threshold | Range: 0.0%~100.0% | 10.0% |
| F07.15 | Analog input disconnection detection time | Range: 0.0~500.0s | 3.0s |

| | | | |
|---------------|---|--|-----------|
| F07.16 | Analog disconnection protection option | Range: units digit: 0、1、2 tens digit: 0、1、2 | 10 |
|---------------|---|--|-----------|

units digit: disconnection detection channel choice

0: invalid

1: AI1

2: AI2

Tens digit: Disconnection protection way

0: Stop according to stop mode

1: Fault, free stop

2: continue operation

When channel (AI1 or AI2) selected by the units of F07.16 input a value less than the threshold defined by F07.14 and it is sustained exceed the time defined by F07.15, the program will generate a analog channel disconnection signal output, which can output signal for external by multifunctional output terminals (function 48) and the inverter will action according the command defined by tens of F07.16: when the tens of F07.16 = 1, the inverter will be submitted to the E-41 fault (analog channel disconnection protection; when tens of F07.16 = 0, inverter Stops according to stop mode.

By this function, AI1 and AI2 can be used to test position signal and motor temperature signal of the system and take corresponding protective measures. When don't need this function, set the units of F07.16 to 0.

| | | | |
|---------------|-----------------|--|--|
| F07.17 | Reserved | | |
|---------------|-----------------|--|--|

| | | | | |
|---|---|---|---|---|
| 1 | 1 | 1 | 0 | E |
| 1 | 1 | 1 | 1 | F |

Bit refers to units, tens, hundreds or thousands displayed in operation panel.

F08.00 parameter defines valid logic state of Xi input terminal:

Positive logic: Xi terminal and corresponding common port closed valid, opened invalid;

Negative logic: Xi terminal and corresponding common port closed invalid, opened valid;

When BIT selects 0, it indicates positive logic; 1 indicates negative logic. Proper setting of this parameter can realize correct logic input without changing terminal wiring.

| | | | |
|---------------|-----------------------------------|----------------------------|---------------|
| F08.01 | Input terminal filter time | Range: 0.000~1.000s | 0.010s |
|---------------|-----------------------------------|----------------------------|---------------|

F08.01 parameter sets filter time of input terminal check. When input terminal state is changed, the terminal state change is valid only when the set filter time is unchanged. Otherwise, it will remain the last state, thus effectively reduce malfunction caused by interruption. The group C monitor state is for the state of the disposed parameter. When demand terminal as the high speed function, low down the value of this parameter is needed in case losing the signal.

| | | | |
|---------------|--------------------------------------|---------------------------|--------------|
| F08.02 | X1 Input terminal closed time | Range: 0.00~99.99s | 0.00s |
| F08.03 | X1 Input terminal opened time | Range: 0.00~99.99s | 0.00s |
| F08.04 | X2 Input terminal closed time | Range: 0.00~99.99s | 0.00s |
| F08.05 | X2 Input terminal opened time | Range: 0.00~99.99s | 0.00s |
| F08.06 | X3 Input terminal closed time | Range: 0.00~99.99s | 0.00s |
| F08.07 | X3 Input terminal opened time | Range: 0.00~99.99s | 0.00s |
| F08.08 | X4 Input terminal closed time | Range: 0.00~99.99s | 0.00s |
| F08.09 | X4 Input terminal opened time | Range: 0.00~99.99s | 0.00s |
| F08.10 | X5 Input terminal closed time | Range: 0.00~99.99s | 0.00s |
| F08.11 | X5 Input terminal opened time | Range: 0.00~99.99s | 0.00s |
| F08.12 | X6 Input terminal closed time | Range: 0.00~99.99s | 0.00s |
| F08.13 | X6 Input terminal opened time | Range: 0.00~99.99s | 0.00s |
| F08.14 | X7 Input terminal closed time | Range: 0.00~99.99s | 0.00s |
| F08.15 | X7 Input terminal opened time | Range: 0.00~99.99s | 0.00s |
| F08.16 | X8 Input terminal closed time | Range: 0.00~99.99s | 0.00s |

| | | | |
|---------------|--------------------------------------|---------------------------|--------------|
| F08.17 | X8 Input terminal opened time | Range: 0.00~99.99s | 0.00s |
|---------------|--------------------------------------|---------------------------|--------------|

F08.02 ~ F08.17 parameter defines the corresponding delay time of Xi input terminal from closed to opened or opened to closed so as to meet user's multiple requirements. This parameter does not affect the monitor value of input terminal state. You can revise the parameter to control the filtering when the interruption is strong.

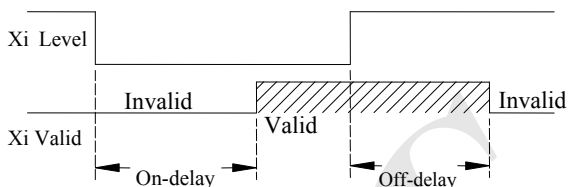

Fig. 7-13 closed and opened delay

| | | | |
|---------------|---|--------------------|----------|
| F08.18 | Input terminal X1 function selection | Range: 0~96 | 1 |
| F08.19 | Input terminal X2 function selection | Range: 0~96 | 2 |
| F08.20 | Input terminal X3 function selection | Range: 0~96 | 0 |
| F08.21 | Input terminal X4 function selection | Range: 0~96 | 0 |
| F08.22 | Input terminal X5 function selection | Range: 0~96 | 0 |
| F08.23 | Input terminal X6 function selection | Range: 0~96 | 0 |
| F08.24 | Input terminal X7 function selection | Range: 0~96 | 0 |
| F08.25 | Input terminal X8 function selection | Range: 0~96 | 0 |

Multi-functional input terminal X1 ~ X8 provides users with up to 95 selections, which can be selected based on actual applications. For details, please refer to parameter function Table 7-3.

Table 7-3 Multi-functional input selection function table

| Content | Function | Content | Function |
|---------|-------------------------------------|---------|--|
| 0 | Leave control terminal unused | 49 | Command switchover to panel |
| 1 | Forward running FWD terminal | 50 | Command switchover to terminal |
| 2 | Reverse running REV terminal | 51 | Command switchover to communication |
| 3 | External forward jogging control | 52 | Running command Channel selection terminal 1 |
| 4 | External reverse jogging control | 53 | Running command Channel selection terminal 2 |
| 5 | Multi-step speed control terminal 1 | 54 | Forward prohibited command (Stop according to the stop mode, |

7 Detailed function specification

| | | | |
|----|--|----|---|
| | | | invalid for jogging command) |
| 6 | Multi-step speed control terminal 2 | 55 | Reverse prohibited command (Stop according to the stop mode, invalid for jogging command) |
| 7 | Multi-step speed control terminal 3 | 56 | Swinging frequency input |
| 8 | Multi-step speed control terminal 4 | 57 | Resetting state of swinging frequency |
| 9 | Acceleration/deceleration time selection terminal 1 | 58 | Interior counter reset end |
| 10 | Acceleration/deceleration time selection terminal 2 | 59 | Interior counter input end |
| 11 | Acceleration/deceleration time selection terminal 3 | 60 | Internal timer resetting |
| 12 | Acceleration/deceleration time selection terminal 4 | 61 | Internal timer triggering |
| 13 | Main and auxiliary frequency operational rule selection terminal 1 | 62 | Length count input |
| 14 | Main and auxiliary frequency operational rule selection terminal 2 | 63 | Length reset |
| 15 | Main and auxiliary frequency operational rule selection terminal 3 | 64 | Reset this operation time |
| 16 | Frequency ascending command (UP) | 65 | Speed/torque control switching |
| 17 | Frequency descending command (DOWN) | 66 | Point positioning enabled terminal(F00.24=2 valid). |
| 18 | Frequency ascending/descending frequency resetting | 67 | Zero-speed servo enabled terminal(F00.24=2 valid). |
| 19 | Multi-step closed loop terminal 1 | 68 | Motor position reset terminal(F00.24=2 valid). |
| 20 | Multi-step closed loop terminal 2 | 69 | Recovery point positioning terminal (F00.24=2 valid). |
| 21 | Multi-step closed loop terminal 3 | 70 | Reserved |
| 22 | External equipment failure input | 71 | Reserved |
| 23 | External interruption input | 72 | Reserved |
| 24 | External resetting input | 73 | Reserved |
| 25 | Free stop input | 74 | Reserved |
| 26 | External stop instruction—Stop according to the stop mode | 75 | Reserved |
| 27 | stop DC braking input command DB | 76 | Reserved |
| 28 | inverter running prohibited—Stop according to the stop mode | 77 | Reserved |
| 29 | Acceleration/deceleration prohibited command | 78 | Reserved |
| 30 | Three-wire running control | 79 | Reserved |
| 31 | Process PID invalid | 80 | Reserved |
| 32 | Process PID stop | 81 | Reserved |
| 33 | Process PID integral holding | 82 | Reserved |
| 34 | Process PID integral resetting | 83 | Reserved |
| 35 | Process PID function negation (Closed loop adjustment feature | 84 | Reserved |

| | | | |
|----|---|----|----------------------------------|
| | negation) | | |
| 36 | Simple PLC invalid | 85 | Reserved |
| 37 | Simple PLC halted | 86 | Reserved |
| 38 | Simple PLC stop state resetting | 87 | Reserved |
| 39 | Main frequency switchover to digit (keypad) | 88 | Reserved |
| 40 | Main frequency switchover to AI1 | 89 | Reserved |
| 41 | Main frequency switchover to AI2 | 90 | Reserved |
| 42 | Main frequency switchover to EA11 | 91 | Pulse frequency input (X8 VALID) |
| 43 | Main frequency switchover to EA12 | 92 | Pulse width PWM INPUT (X8 VALID) |
| 44 | Main frequency setting channel selection terminal 1 | 93 | Reserved |
| 45 | Main frequency setting channel selection terminal 2 | 94 | Reserved |
| 46 | Main frequency setting channel selection terminal 3 | 95 | Reserved |
| 47 | Main frequency setting channel selection terminal 4 | 96 | Reserved |
| 48 | Auxiliary frequency reset | - | - |

Function introduction in Table 7-3 is as shown below:

1, 2: External command terminal. When running command channel is terminal running command, control inverter's forward and reverse by external terminal.

3, 4: External jogging command terminal. Set as any running command channel setting running command, control inverter's jogging forward and jogging reverse by external terminal.

5 ~ 8: Multi-step running terminal. By setting these functions' terminal ON/OFF combination, up to 15 multi-step running frequencies can be set. The increase and decrease time of each step corresponds to the each step time. The corresponding motor running direction of each phase in multi-speed is determined by the ten's place of F10.01~F10.15.

Table 7-4 Multi-step running selection table

| K ₄ | K ₃ | K ₂ | K ₁ | Frequency setting |
|----------------|----------------|----------------|----------------|---------------------------|
| OFF | OFF | OFF | OFF | Other running frequencies |
| OFF | OFF | OFF | ON | Multi-step frequency 1 |
| OFF | OFF | ON | OFF | Multi-step frequency 2 |
| OFF | OFF | ON | ON | Multi-step frequency 3 |
| OFF | ON | OFF | OFF | Multi-step frequency 4 |
| OFF | ON | OFF | ON | Multi-step frequency 5 |
| OFF | ON | ON | OFF | Multi-step frequency 6 |
| OFF | ON | ON | ON | Multi-step frequency 7 |
| ON | OFF | OFF | OFF | Multi-step frequency 8 |
| ON | OFF | OFF | ON | Multi-step frequency 9 |

| | | | | |
|----|-----|-----|-----|-------------------------|
| ON | OFF | ON | OFF | Multi-step frequency 10 |
| ON | OFF | ON | ON | Multi-step frequency 11 |
| ON | ON | OFF | OFF | Multi-step frequency 12 |
| ON | ON | OFF | ON | Multi-step frequency 13 |
| ON | ON | ON | OFF | Multi-step frequency 14 |
| ON | ON | ON | ON | Multi-step frequency 15 |

When using multi-step speed to run and simple PLC to run, use multi-step speed frequency (F10.31 ~ F10.45) above, take multi-step speed running as an example:
Define control terminal X1, X2, X3, X4:

When F08.18=5, F08.19=6, F08.20=7, F08.21= 8, X1, X2, X3, X4 are used to define multi-step speed running, as shown in Fig. 7-14.

In fig7-14. Take the example of terminal running command channel, the ten's place of F10.01~F10.15 are both 2, and X5 is set as forward running terminal, X6 is reverse running terminal, for the running control of forward direction and reverse direction.

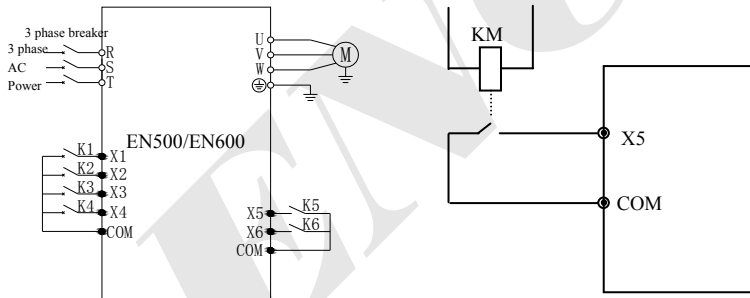

Fig. 7-14 Multi-step speed running wiring Fig. 7-15 Peripheral equipment fault Normally Open

9 ~ 12: Acceleration/deceleration time terminal selection. By ON/OFF of acceleration/deceleration time terminal, acceleration/deceleration time 1 ~ 15 can be selected. For details, see Table 7-5:

Table 7-5 Acceleration/deceleration time terminal selection

| Acceleration/ deceleration time selection terminal 4 | Acceleration/ deceleration time selection terminal 3 | Acceleration/ deceleration time selection terminal 2 | Acceleration/ deceleration time selection terminal 1 | Acceleration/deceleration time selection |
|---|---|---|---|---|
| OFF | OFF | OFF | ON | Acceleration/deceleration time 1 |
| OFF | OFF | ON | OFF | Acceleration/deceleration time 2 |
| OFF | OFF | ON | ON | Acceleration/deceleration time 3 |
| OFF | ON | OFF | OFF | Acceleration/deceleration time 4 |
| OFF | ON | OFF | ON | Acceleration/deceleration time 5 |
| OFF | ON | ON | OFF | Acceleration/deceleration time 6 |

| | | | | |
|-----|-----|-----|-----|-----------------------------------|
| OFF | ON | ON | ON | Acceleration/deceleration time 7 |
| ON | OFF | OFF | OFF | Acceleration/deceleration time 8 |
| ON | OFF | OFF | ON | Acceleration/deceleration time 9 |
| ON | OFF | ON | OFF | Acceleration/deceleration time 10 |
| ON | OFF | ON | ON | Acceleration/deceleration time 11 |
| ON | ON | OFF | OFF | Acceleration/deceleration time 12 |
| ON | ON | OFF | ON | Acceleration/deceleration time 13 |
| ON | ON | ON | OFF | Acceleration/deceleration time 14 |
| ON | ON | ON | ON | Acceleration/deceleration time 15 |

13 ~ 15: Main and auxiliary frequency operational rule selection terminal. By ON/OFF of frequency setting channel selection terminal 13, 14, and 15, 7 kinds of main and auxiliary frequency operational rules defined in F01.06 parameter can be realized. Switchover between main and auxiliary operational rule terminal is prior to function code F01.06 setting. For details, please see table 7-6:

Table 7-6 Selection table of terminal main and auxiliary frequency operational rule

| Main and auxiliary operational rule selection terminal 3 | Main and auxiliary operational rule selection terminal 2 | Main and auxiliary operational rule selection terminal 1 | Main and auxiliary operational rule selection |
|--|--|--|---|
| OFF | OFF | OFF | Decided by F01.06 |
| OFF | OFF | ON | Synthesized frequency is sub-frequency |
| OFF | ON | OFF | Operation rule: addition |
| OFF | ON | ON | Operation rule: subtraction |
| ON | OFF | OFF | Operation rule: multiplication |
| ON | OFF | ON | Synthesized frequency is Max. value |
| ON | ON | OFF | Synthesized frequency is min. value |
| ON | ON | ON | Synthesized frequency is nonzero value |

16, 17: Frequency ascending command UP/descending command DOWN. Realize frequency ascending or descending by control terminal, substitute operation keypad for remote control. Normal running F01.00 or F01.03 set as 3 is valid. Ascending/descending rate is set in F18.06 and F18.07.

18: Frequency ascending/descending frequency resetting.

When frequency setting is set as terminal UP/DOWN, this terminal can eliminate the set frequency value by terminal UP/DOWN.

19 ~ 21: Multi-step closed loop setting terminal. By ON/OFF of multi-step closed loop setting terminal, Table 7-7 Multi-step closed loop setting selection can be realized.

Table 7-7 Multi-step closed loop setting selection table

| Multi-step closed loop setting selection terminal 3 | Multi-step closed loop setting selection terminal 2 | Multi-step closed loop setting selection terminal 1 | Multi-step closed loop setting selection |
|---|---|---|--|
| OFF | OFF | OFF | Closed loop setting decided by F11.01 |
| OFF | OFF | ON | Multi-step closed loop setting 1 |
| OFF | ON | OFF | Multi-step closed loop setting 2 |
| OFF | ON | ON | Multi-step closed loop setting 3 |
| ON | OFF | OFF | Multi-step closed loop setting 4 |
| ON | OFF | ON | Multi-step closed loop setting 5 |
| ON | ON | OFF | Multi-step closed loop setting 6 |
| ON | ON | ON | Multi-step closed loop setting 7 |

22: External equipment failure jump-in. with this terminal, peripheral equipment fault signal can be input, which is convenient for inverter to perform fault monitoring for peripheral equipment, as shown in Fig. 7-15.

23: External interruption input. When the inverter is running, after receiving external interruption signal, it blocks output, and runs with zero frequency. Once external interruption signal is released, and inverter running command is still valid, inverter auto revolving speed tracking starts, the inverter restarts.

24: External resetting input. When fault alarm occurs to the inverter, you can reset fault by this terminal. Its function and operation keypad  key function are in accordance.

25: Free stop input. The purpose of this function and free stop set in F02.11 is the same, but here it uses control terminal to realize, which is convenient for remote control.

26: External stop instruction. This command is effective for all running command channel, when this function terminal is effective, the inverter stops running according to mode set by F2.11.

27: Stop DC braking input command DB. Implement DC braking to the motor during stop by control terminal so as to realize emergency stop and accurate position of the motor. During deceleration stop, if this function terminal closed, when frequency is lower than the brake starting frequency F02.14, it will brake according to brake current defined in F02.16. It will not stop until terminal is opened.

28: Inverter running prohibited. The running inverter stops freely when this terminal is effective, and forbidden to start in waiting status. It is mainly

applied to occasion needing safe linkage.

29: Acceleration/deceleration prohibited command. When this function is valid, keep the motor away from any external signal (except stop command), maintain current revolving speed running.



Note

This function is invalid in normal deceleration stop process.

30: Three-wire running control. Refer to F08.26 operating mode (Three-wire operating mode) function introduction.

31: Process PID invalid. Realize flexible switchover in low-level running mode under closed-loop running status.



Note

1. Switchover between closed-loop and low level running mode can be available only when the inverter runs in closed-loop mode (F11.00=1 or F12.00=1).
2. When switching to low-level running mode, start-stop control, direction and acceleration/deceleration time comply with relevant setting of running mode.

32: Process PID stop. Invalid when PID stops, when inverter maintains current output frequency, PID regulation of frequency source is no more performed.

33: Process PID integral holding. PID integral impact maintains, and will not regulate according to the output quantity.

34: Process PID integral resetting. When the terminal is valid, PID integral regulation function halts, but PID proportional control and differential control function are still valid.

35: Process PID function negation. When the terminal is valid, direction of PID effect and setting direction of F11.13 is opposite.

36: simple PLC invalid. Realize flexible switchover in low-level running mode under PLC running status.



Note

1. Switchover between PLC and low level running mode can be available only when the inverter runs in PLC mode (F10.00 unit's digit is not 0).
2. When switching to low-level running mode, start-stop control, direction and acceleration/deceleration time comply with relevant setting of running mode.

37: Simple PLC halted. It is to control the stop of running PLC, when the terminal is valid, the inverter runs at zero frequency, PLC running does not time; after invalid implementation, auto revolving speed tracking starts and keep on running PLC.

38: Simple PLC stop state resetting. Under stop status of PLC running mode, will clear PLC run step, runtime, run frequency etc. recorded when PLC running stops if this terminal is effective, please see F10 group function description.

39: Main frequency switchover to digital setting (keypad). The main frequency provision channel is switched to keypad digital provision when this terminal is valid (setting frequency by keypad up and down key).

40: Main frequency switchover to AI1. The main frequency provision channel is switched to analog quantity AI1 provision when this terminal is valid

41: Main frequency switchover to AI2. The main frequency provision channel is switched to analog quantity AI2 provision when this terminal is valid

42: Main frequency switchover to EAI1. When extended analog quantity is valid, the main frequency provision channel is switched to extended analog quantity EAI1 provision when this terminal is valid,

43: Main frequency switchover to EAI2. When extended analog quantity is valid, , the main frequency provision channel switchover to extended analog quantity EAI2 provision when this terminal is valid.

44 ~ 47: Main frequency setting channel selection terminal. By ON/OFF of selection terminal 1 ~ 4, Free selection of main frequency setting channel can be realized by terminal. The priority of main frequency setting channel selection terminal (terminal function 44 ~ 47) is higher than the main frequency switchover to (terminal function 41, 42, 43). For details, see table 7-8.

Table 7-8 Main frequency setting channel selection terminal

| Channel selection terminal 4 | Channel selection terminal 3 | Channel selection terminal 2 | Channel selection terminal 1 | Main frequency setting channel selection terminal |
|------------------------------|------------------------------|------------------------------|------------------------------|---|
| OFF | OFF | OFF | ON | Operation keypad digital setting |
| OFF | OFF | ON | OFF | AI1 analog setting |
| OFF | OFF | ON | ON | AI2 analog setting |
| OFF | ON | OFF | OFF | Terminal UP/DOWN setting |
| OFF | ON | OFF | ON | Communication setting |
| OFF | ON | ON | OFF | EAI1 analog setting (extended) |
| OFF | ON | ON | ON | EAI2 analog setting (extended) |
| ON | OFF | OFF | OFF | rapid pulse setting (X8) |
| ON | OFF | OFF | ON | Pulse width setting (X8) |
| ON | OFF | ON | OFF | Terminal encoder setting (X1, |

| | | | | |
|----|-----|-----|-----|--|
| | | | | X2) |
| ON | OFF | ON | ON | Keypad analog potentiometer setting (optional) |
| ON | ON | OFF | OFF | Reserved |
| ON | ON | OFF | ON | Reserved |
| ON | ON | ON | OFF | Reserved |

48: Auxiliary frequency reset. Only valid for digit auxiliary frequency, when this function terminal is valid, reset auxiliary frequency setting quantity, setting frequency is completely decided by main frequency setting channel.

49: Command switchover to panel. When current command source is reset by terminal or communication, switchover between current command source and keypad command setting can be realized by this terminal.

50: Command switchover to terminal. When current command source is reset by keypad or communication, switchover between current command source and terminal command setting can be realized by this terminal.

51: Command switchover to communication. When current command source is reset by keypad or terminal, switchover between current command source and communication command setting can be realized by this terminal.

52, 53: Running command Channel selection terminal. For details, please refer to Table 7-9.

Table 7-9 Running command channel logic mode

| Running command channel selection terminal 2 | Running command channel selection terminal 1 | Running command channel |
|--|--|--|
| OFF | OFF | Invalid |
| OFF | ON | Operation keypad running command channel |
| ON | OFF | Terminal running command channel |
| ON | ON | Communication running command channel |

54: Forward prohibited command. Enable this terminal during the forward running process, and the inverter stops according to the stop mode. First enable this terminal, and then forward running enters zero frequency running status. Jogging running is not affected by this.

55: Reverse prohibited command. Function and “Forward prohibited command” are opposite.

56: Swinging frequency input. When the starting mode of swinging frequency is manual input, this terminal is valid, and swinging frequency function is valid. See F13 group function parameter instruction. When swinging frequency is set as manual input, this terminal is invalid, run with preset frequency of swinging frequency.

57: Resetting state of swinging frequency. When selecting swinging frequency function, no matter auto or manual input mode, closing this terminal will clear state information of swinging frequency memorized in the inverter. When opening this terminal, swinging frequency restarts. For details, please see F13 group function.

58: Interior counter reset end. Reset inverter built-in counter, and go with counter triggering signal input. For details, please see parameter F08.27, F08.28.

59: Interior counter input end. Interior counter's counting pulse input port, pulse max. frequency: 50.0KHz.

60: Interior timer reset end. Reset inverter built-in timer, goes with timer triggering-end signal input.

61: Interior timer triggering end. See parameter F08.29 function.

62: Length count input. Length counting input terminal, see fixed length function of F13 group parameter.

63: Length reset. When the terminal is valid, reset internal length value, see F13 fixed length function of parameter group.

64: Reset this operation time. When the terminal is valid, the running counting time of this inverter is reset, see timing running defined in F18 group.

65: speed/torque control switching. The function of this terminal is only effective under the mode of Speed Mode, this terminal can realize the dynamic switching between torque Mode and Speed Mode.

66: Point positioning enabled terminal(F00.24=2 valid). See the parameter description at group 16.

67: Zero-speed servo enabled terminal(F00.24=2 valid). See the parameter description at group 16.

68: Motor position reset terminal(F00.24=2 valid). See the parameter description at group 16.

69: Recovery point positioning terminal(F00.24=2 valid). See the parameter description at group 16.

70~90: Reserved

91: Pulse frequency input (X8 valid). Only valid for multi-functional input terminal X8, this function terminal accepts pulse signal as frequency setting, relationship between the input signal pulse frequency and setting frequency is as shown in F06 and F07 group parameter.

92: Pulse width PWM input (X8 valid). Only valid for multi-functional input terminal X8, this function terminal accepts PWM signal, check pulse width as frequency setting, relationship between input PWM Pulse width and setting frequency is as shown in F06 and F07 group parameter.

93~96:Reserved

| | | | |
|---------------|---|-------------------|----------|
| F08.26 | FWD/REV operating mode selection | Range: 0~4 | 0 |
|---------------|---|-------------------|----------|

This parameter defines five different modes by controlling external terminal inverter running.

0: Two-wire control mode 1

| K2 | K1 | Operating command |
|----|----|-------------------|
| 0 | 0 | Stop |
| 1 | 0 | REV |
| 0 | 1 | FWD |
| 1 | 1 | Stop |

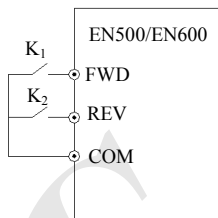

Fig. 7-16 Two-wire operating mode 1

1: Two-wire control mode 2

| K2 | K1 | Operating command |
|----|----|-------------------|
| 0 | 0 | Stop |
| 1 | 0 | Stop |
| 0 | 1 | FWD |
| 1 | 1 | REV |

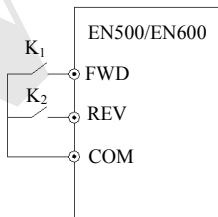

Fig. 7-17 Two-wire operating mode 2

2: Two-wire control mode 3 (monopulse control mode)

Monopulse control is triggered-type control. After triggering SB1 once, it forwards runs. Retriggering SB1 once, it stops. Triggering SB1 once, it reversely runs. Retriggering SB2 once, it stops. If it is forward running, the inverter stops when triggering SB2 once. Retriggering SB1 once, it stops. If it is reverse running, the inverter stops when triggering SB1 once.

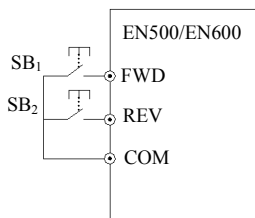

Fig. 7-18 Two-wire control mode 3

3: Three-wire control mode 1

Defines are as follows:

SB1: stop button

SB2: forward button

SB3: reverse button

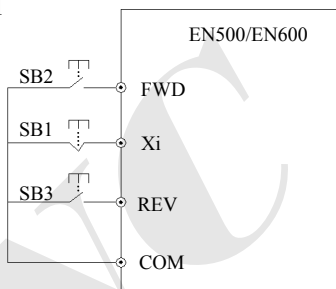

Fig. 7-19 Three-wire operating mode 1

X_i is $X_1 \sim X_8$'s Multi-functional Input terminal, at this moment, define its corresponding terminal function as “Three-wire running control” function of No.30.

4: Three-wire control mode 2

SB1: stop button

SB2: run button

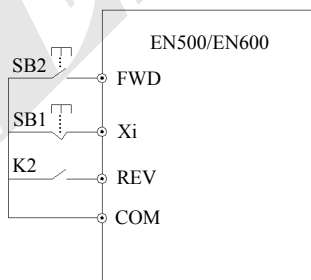

| K2 | Running direction selection |
|----|-----------------------------|
| 0 | Forward |
| 1 | Reverse |

Fig. 7-20 Three-wire operating mode 2

X_i is $X_1 \sim X_8$'s Multi-functional input terminal, At this moment, define its corresponding terminal function as “Three-wire running control” function of No. 30.

| | | | |
|---------------|--|-----------------------|----------|
| F08.27 | Set internal count value to setting | Range: 0~65535 | 0 |
|---------------|--|-----------------------|----------|

| | | | |
|---------------|--|-----------------------|----------|
| F08.28 | Specify internal count to setting | Range: 0~65535 | 0 |
|---------------|--|-----------------------|----------|

F08.27 and F08.28 are to additionally define functions of 30 and 31 in 7-10.

When Xi (Counting trigger signal input function terminal) output pulse reaches F08.27 defined value, Y1 (Y1 is set as internal count value final value to) outputs one indicating signal, as shown in Fig. 7-21, When Xi inputs the eighth pulse, Y1 outputs one indicating signal. At this moment, F8.27=8.

When Xi (Counting trigger signal input function terminal) output pulse reaches F08.28 defined value, Y2 (Y2 is set as internal counter specified value to) outputs one indicating signal, until set count value arrives.

As shown in Fig. 7-21, when Xi inputs the fifth pulse, Y2 starts outputting one indicating signal. Until set count value 8 arrives, F08.28=5. When specified count value is greater than set count value, specified count value Invalid.

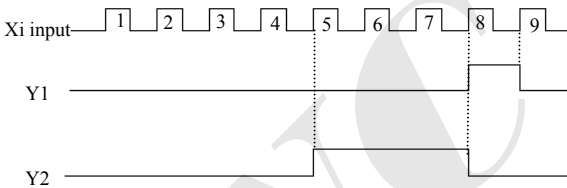

Fig. 7-21 set count value setting and specified count value setting

| | | | |
|---------------|--------------------------------------|---------------------------|--------------|
| F08.29 | Internal timer timing setting | Range: 0.1~6000.0s | 60.0s |
|---------------|--------------------------------------|---------------------------|--------------|

This parameter sets timing time of inverter internal timer, timer is triggered by external triggering terminal (Xi terminal function no. is 61), the timer starts timing upon receiving external triggering signal. After reaching timing time, Yi terminal outputs a breadth of 0.5s valid pulse signal. When internal timer clearing terminal is valid (Xi terminal function is set as 60), internal timer is reset.

| | | | |
|---------------|--|----------------------------|---------------|
| F08.30 | Terminal pulse encoder frequency rate | Range: 0.01~10.00Hz | 1.00Hz |
|---------------|--|----------------------------|---------------|

This parameter defines main frequency regulation speed during terminal pulse encoder setting frequency (F01.00=9). Main frequency terminal encoder pulse input can only choose channel X1 and X2 combination; auxiliary frequency terminal encoder pulse input can only choose channel X3 and X4 combination, and the rate of the auxiliary frequency encoder frequency is the fixed rate.



Note

When 9 is selected in F01.00 and F01.03, X1~X4 can only be used as encoder frequency setting. Other terminal functions defined by F08.18~F08.21 are invalid.

| | | | |
|---------------|-----------------------------------|---|-----------|
| F08.31 | Special function selection | Range: units digit:0~1 tens digit :0~1 | 00 |
|---------------|-----------------------------------|---|-----------|

Units digit: jogging priority level selection

0: the highest priority level

1: the lowest priority level

Tens digit: keypad adjustment of display setting (under speed control mode)

0: display setting frequency

1: display setting rotation speed

7.10 Switch output function parameter group: F09

| | | | |
|---------------|---|--------------------|-----------|
| F09.00 | Open-collector output terminal Y1 output setting | Range: 0~60 | 0 |
| F09.01 | Open-collector output terminal Y2 output setting | Range: 0~60 | 0 |
| F09.02 | Open-collector output terminal Y3 output setting | Range: 0~60 | 0 |
| F09.03 | Open-collector output terminal Y4 output setting | Range: 0~60 | 0 |
| F09.04 | Programmable relay output setting | Range: 0~60 | 22 |

Functions of the above parameters are used to select Y1 ~ Y4 and relay output terminals. Table 7-10 shows the functions of the above 4 terminals. One function can be selected repeatedly.

Open-collector (Yi) and high-speed pulse (DO) output share terminal Y4. Y4 terminal as the high-speed pulse function to be modified F00.22 thousands place to 1.

Table7-10 Output terminals function selection diagram

| Setting | Function | Setting | Function |
|---------|---|---------|--|
| 0 | No output | 31 | Set count value reached |
| 1 | Frequency inverter running(RUN) | 32 | Designated count value reached |
| 2 | Frequency inverter Forward running | 33 | Shutdown time arrival of the running |
| 3 | Frequency inverter Reverse running | 34 | Time arrival of the running |
| 4 | Frequency inverter DC brake | 35 | Setup running time arrived |
| 5 | Frequency inverter Ready for operation(RDY) | 36 | Setup power-on time arrived |
| 6 | Shutdown command indicator | 37 | 1st pump variable frequency |
| 7 | Zero current state | 38 | 1st pump frequency |
| 8 | Over current state | 39 | 2nd pump variable frequency |
| 9 | Current 1 arrived | 40 | 2nd pump frequency |
| 10 | Current 2 arrived | 41 | Communication given |
| 11 | Frequency inverter Zero-frequency output | 42 | Torque control speed limiting |
| 12 | Frequency arriving signal (FAR) | 43 | Torque arriving output |
| 13 | Frequency level detection signal 1 (FDT1) | 44 | Positioning completion |
| 14 | Frequency level detection signal 2(FDT2) | 45 | The brake logic 1 |
| 15 | Output frequency arriving upper limit(FHL) | 46 | The brake logic 2 |
| 16 | Output frequency arriving lower limit(FLL) | 47 | Frequency inverter running 1 |
| 17 | Frequency 1 arrived | 48 | Analog input disconnection signal output |
| 18 | Frequency 2 arrived | 49 | X1 terminal closed valid |
| 19 | Frequency inverter overload pre- alarm signal(OL) | 50 | X2 terminal closed valid |

| | | | |
|----|---|----|----------|
| 20 | Frequency inverter Low voltage lock-up signal(LU) | 51 | Reserved |
| 21 | External stopping command(EXT) | 52 | Reserved |
| 22 | Frequency inverter fault | 53 | Reserved |
| 23 | Frequency inverter warning | 54 | Reserved |
| 24 | Simple PLC operation running | 55 | Reserved |
| 25 | Completion of simple PLC operation | 56 | Reserved |
| 26 | Simple PLC cycle-running completed | 57 | Reserved |
| 27 | Simple PLC suspended | 58 | Reserved |
| 28 | Upper and lower limit of Wobble | 59 | Reserved |
| 29 | Setup length arrived | 60 | Reserved |
| 30 | Internal counter final value arrived | - | - |

The instructions of the function output terminals listed in table 7-10 are as below:

0: The terminal function is idle.

1:Frequency inverter is running(RUN).The Drive is in the running state, output the indicator signal.

2. Frequency inverter is forward running. The Drive is in the forward running state, output the indicator signal.

3. Frequency inverter is reversed running. The Drive is in reversed running state, output the indicator signal.

4.Frequency inverter is DC braking. The Drive is in DC braking state, output the indicator signal.

5. Frequency inverter is ready to run. This signal being valid means that the Drive bus voltage is normal, the Drive is running and forbidding the terminal is invalid, it can accept a start command.

6. Shutdown command indicator. When the shutdown command is valid, output the indicator signal.

7. Zero current is arrived. When detected the output meet the zero current state, output the indicator signal. Please refer to the instruction of F09.12and F09.13parameters for details.

8. Over current is arrived. When the output current meet the over current detection conditions, output the indicator signal. Please refer to the instruction of F09.14and F09.15 parameters for details.

9. Current 1 arrived. When the output current reaches the detection conditions to meet the current 1, output the indicator signal. Please refer to the instruction of F09.16and F09.17 parameters for details.

10. Current 2 arrived. When the output current reaches the detection conditions to meet the current 2, output the indicator signal. Please refer to the instruction of F09.18and F09.19 parameters for details.

11. Frequency inverter Zero frequency output. Please refer to the function

instruction of F09.10 and F09.11.

12. Frequency arriving signal (FAR). Please refer to the function instruction of F09.05.

13. Frequency level detection signal 1 (FTD1). Please refer to the function instruction of F09.06, F09.07.

14. Frequency level detection signal 2 (FTD2). Please refer to the function instruction of F09.08, F09.09.

15. Output frequency reaches upper limit (FHL). When the running frequency reaches upper limit, the output is indicator signal.

16. Output frequency reaches lower limit (FHL). When the running frequency reaches lower limit, the output is indicator signal.

17. Frequency 1 arriving output. Please refer to the function instruction of F09.20, F09.21.

18. Frequency 2 arriving output. Please refer to the function instruction of F09.22, F09.23.

19. Frequency inverter overload pre-alarm signal. Frequency inverter output current exceeds F19.06 overload pre-alarm detection levels, and time is greater than F19.07 overload pre-alarm delay time, output the indicator signal.

20. Frequency inverter Low voltage lock-up signal (LU). When the frequency inverter is running, the DC bus voltage below the limit level, output indication signal.

21. External fault shutdown (EXT). When the frequency inverter appears external fault trip alarm (E-18), output indication signal.

22. Frequency inverter fault. When the frequency inverter detects fault, the output is indication signal.

23. Frequency inverter warning. When the frequency inverter detects alarm, the output is indication signal.

24. Simple PLC during operating. The simple PLC is enabled, and enter into operation state, output indication signal

25. Simple PLC stage operation completed. When the simple PLC stage operation is completed, output indication signal (single pulse signal, the width is 500ms).

26. Simple PLC ends after running a cycle. After the completion of a cycle of simple PLC, output indication signal (single pulse signal, the width is 500ms)

27. Simple PLC pause. When the simple PLC is running into the pause state, output is indication signal.

28. Wobble upper and lower limit. If the frequency fluctuation range calculated by center frequency exceeds the upper limit F01.11 or belows lower

limit F01.12 after selecting the wobble function, it will output indication signal, as shown in Figure 7-22.

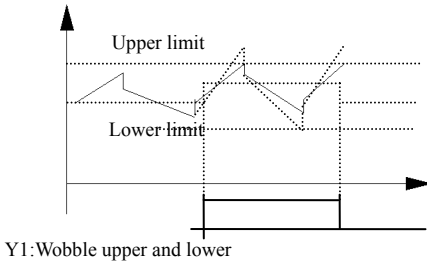

Fig.7-22 Wobble amplitude limit

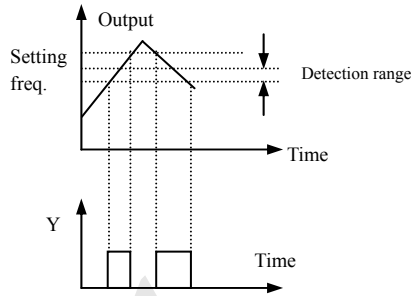

Fig.7-23 Freq. arrival signal output diagram

29. Setup length arrived. When detected the actual length exceeds a set value F13.08, output indication signal.

30. Internal counter final value arrived. Please refer to the function instruction of F08.27.

31. Internal counter specified value arrived. Please refer to the function instruction of F08.28.

32. Internal counter timing meter arrival. Please refer to the function instruction of F08.29.

33. Shutdown time arrival of the running. Frequency inverter runs longer than the setting time of F18.12, output indication signal.

34. Time arrival of the running. Frequency inverter runs longer than the setting time of F18.13, output indication signal.

35. Setup time arrived. Accumulated running time of the frequency inverter reaches the set accumulated running time (F18.10), output indication signal.

36. Setup power-on time arrived. Accumulated power on time of the frequency inverter reaches the set accumulated running time (F18.09), the output indication signal.

37: 1st pump variable frequency.

38: 1st pump frequency.

39: 2nd pump variable frequency.

40: 2nd pump frequency

When using Y1 ~ Y4 achieve two pumps constant pressure water supply, Y1 ~ Y4 functions are arranged in order of 37 to 40. Under constant pressure water supply mode, the four parameters must all set to this value, the terminal functions can be achieved

41: Communication given. In this moment the output of Yi is controlled by communication, Please refer to the related communication protocol for details.

42: torque control speed limiting. Under the mode of torque control, when the actual output frequency is greater than or equal to the value of limiting frequency, this output terminal is effective. The value of speed limiting is defined by parameter F14.16 to F14.19.

43: Torque arriving output. Under the torque control, when the motor torque reaches to the torque command which is after the acceleration and deceleration, and continue for the time defined by F09.48, then output active level.

44: Positioning completion. Under the positioning control, when motor position reaches to the designated spot, then output active level.

45: The brake logic 1. When the output frequency is greater than the value (F09.10 + F09.11), output valid signal (Loose brake signal) , when the output frequency is less than the value defined by F09.10 ,output brake signal .when output no current, downtime, under voltage, that will output brake signals.

46: The brake logic 2. Deceleration stop and the output frequency is less than F09.10, output brake signal. Run the command starts, when the output frequency is greater than the value (F09.10 + F09.11), output valid signal (Loose brake signal). If output no current, downtime, under voltage, that will output brake signals. What difference with the function 45 is that can not produce brake signal in the forward /reverse switching process (that is, the switching process of a controlled object from rising to falling or falling to rising), so as to prolong the life of the brake system.

47: Frequency inverter running 1. When the inverter is in the running state and not jog operation state, output the valid signal.

48: Analog input disconnection signal output. When the disconnection signal defined by F07.14 to F07.16 is valid, a valid pulse of 0.5 second will be output, and then the system will add pump or reduce pump.

49: X1 terminal closed valid

50: X2 terminal closed valid

51~60: Reserved.

| | | | |
|---------------|--|----------------------------|---------------|
| F09.05 | Detection amplitude of frequency arrival(FAR) | Range: 0.00~50.00Hz | 5.00Hz |
|---------------|--|----------------------------|---------------|

This parameter is added in the definition of Table 7-10 on the 12th functions. As shown in Figure 7-23, when the inverter output frequency in the setting frequency of positive and negative detection width, output indication signal.

| | | | |
|---------------|-----------------------------------|--|----------------|
| F09.06 | FDT1(frequency level)level | Range: 0.00Hz~upper limit frequency | 10.00Hz |
| F09.07 | FDT1 lag | Range: 0.00~50.00Hz | 1.00Hz |
| F09.08 | FDT2(frequency level)level | Range: 0.00Hz~upper limit frequency | 10.00Hz |
| F09.09 | FDT2 lag | Range: 0.00~50.00Hz | 1.00Hz |

F09.06, F09.07 is in the definition of Table 7-10 on the 13th Functions, F09.08, F09.08 is in the definition of Table 7-10 on the 14th functions, take an example of 13th functions: When the output frequency exceeds a certain setting frequency (FDT1 level), output indicator Signal, until the output frequency drops below the certain frequency FDT1 frequency level (FDT1 level -FDT1 lag). As shown in Figure 7-24.

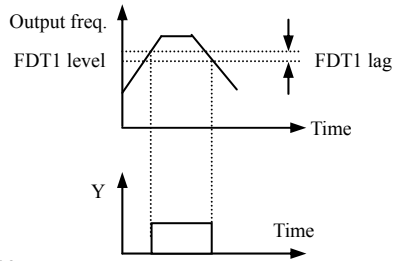

Fig.7-24 Freq. level detection diagram

| | | | |
|---------------|--|--|---------------|
| F09.10 | Zero-frequency signal detection value | Range: 0.00Hz~upper limit frequency | 0.40Hz |
| F09.11 | Zero-frequency backlash | Range: 0.00Hz~upper limit frequency | 0.10Hz |

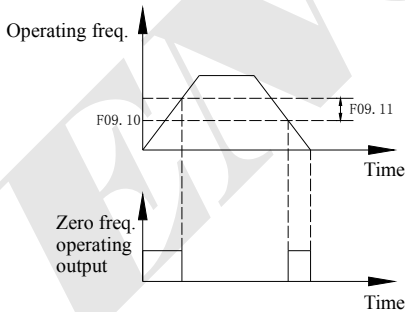

Fig.7-25 Zero-frequency signal detection

Parameter F09.10, F09.11 defines the zero frequency output control function. When the output frequency is within the zero-frequency signal detection range, if Yi output function selects 11, then the output of Yi is indication signal.

| | | | |
|---------------|---|---------------------------|-------------|
| F09.12 | Zero current detection amplitude | Range: 0.0~50.0% | 0.0% |
| F09.13 | Zero current detection time | Range: 0.00~60.00s | 0.1s |

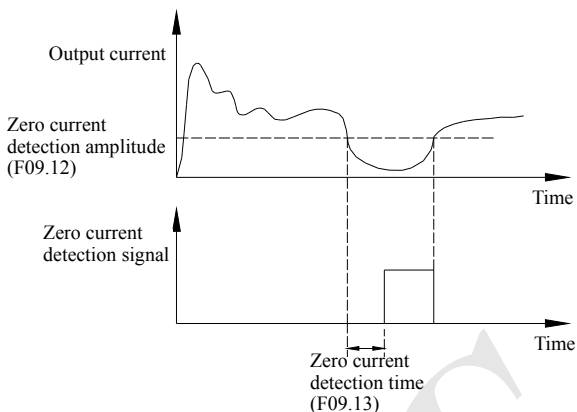

Fig.7-26 Zero current detection diagram

When the output current of the inverter is less than or equal to zero current detection level, and lasts longer than the zero current detection time, then the output of frequency inverter multifunction Yi is indication signal. Figure 7-26 is the schematic of zero current detection.

| | | | |
|---------------|-------------------------------------|---------------------------|---------------|
| F09.14 | Over-current detection value | Range: 0.0~250.0% | 160.0% |
| F09.15 | Over-current detection time | Range: 0.00~60.00s | 0.00s |

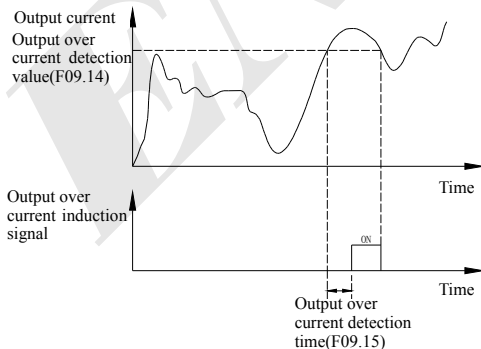

Fig.7-27 Output over-current detection diagram

When the output current of the inverter is greater than the over-current detection points, and lasted longer than the over-current detection time, frequency inverter multifunction Yi output indication signal, Figure 7-27 is the schematic of output over-current detection.

| | | | |
|---------------|---|--------------------------|---------------|
| F09.16 | Current 1 arriving the detection value | Range: 0.0~250.0% | 100.0% |
|---------------|---|--------------------------|---------------|

| | | | |
|---------------|---|--------------------------|---------------|
| F09.17 | Current 1 width | Range: 0.0~100.0% | 0.0% |
| F09.18 | Current 2 arriving the detection value | Range: 0.0~250.0% | 100.0% |
| F09.19 | Current 2 width | Range: 0.0~100.0% | 0.0% |

When the output current of frequency inverter is within the positive and negative detection width of setting current arrival, then the output of frequency inverter multifunction Yi is indication signal.

EN500/EN600 provides two current arrival and detection width parameters, table 7-28 is the function schematic diagram.

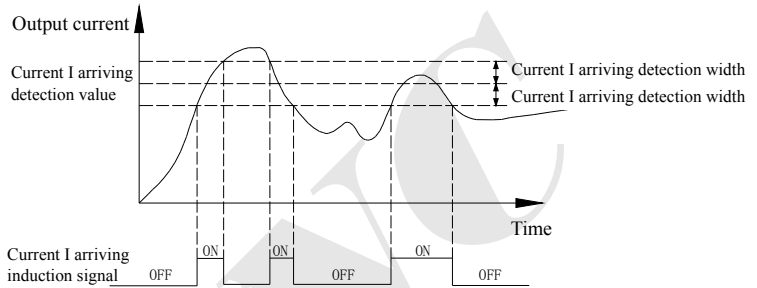

Fig.7-28 Current arriving detection diagram

| | | | |
|---------------|---|---|----------------|
| F09.20 | Frequency 1 arriving detection value | Range:0.00Hz~upper limit frequency | 50.00Hz |
| F09.21 | Frequency 1 arriving detection width | Range:0.00Hz~upper limit frequency | 0.00Hz |
| F09.22 | Frequency 2 arriving detection value | Range:0.00Hz~upper limit frequency | 50.00Hz |
| F09.23 | Frequency 2 arriving detection width | Range:0.00Hz~upper limit frequency | 0.00Hz |

When the output frequency of frequency inverter reaches detecting value of the positive and negative detecting width range, then the output of multifunctional Yi is indication signal.

EN500/EN600 provides two sets of frequency arrival detecting parameters, which have set frequency value and frequency detecting width respectively. Table 7-29 is the diagram of this function.

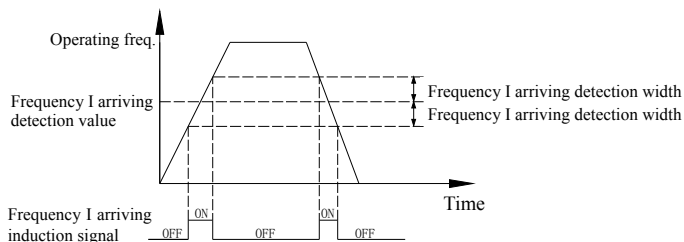

Fig.7-29 Frequency arriving detection diagram

| | | | |
|---------------|---|-------------------------|-------------|
| F09.24 | Positive and negative logic setting of output terminal | Range: 0000~FFFF | 0000 |
|---------------|---|-------------------------|-------------|

This parameter defines the output logic of the standard output terminal Y_i , relay RLY and expand output terminal EY_i , relays $ERYI_1$, $ERLY_2$.

0: positive logic, output terminal and the common terminal close to the valid state, disconnect invalid state

1: reverse logic, output terminal and the common terminal close to the invalid state, disconnect valid state

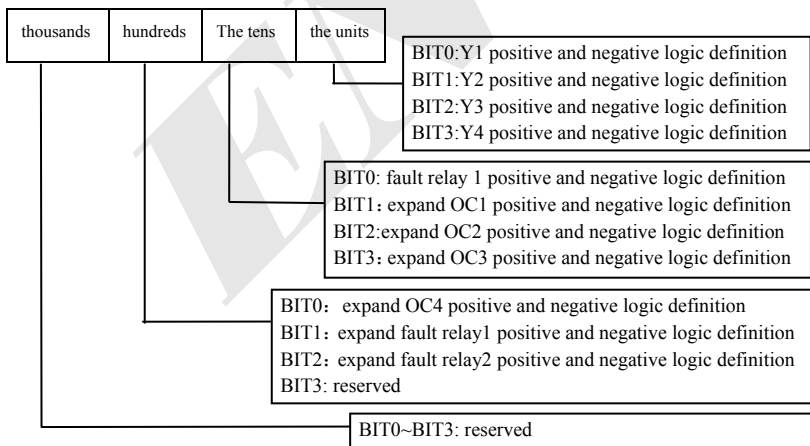

| | | | |
|--------|--------------------------------------|----------------------|--------|
| F09.25 | Y1 output closed delay time | Range: 0.000~50.000s | 0.000s |
| F09.26 | Y1 output disconnected delay time | Range: 0.000~50.000s | 0.000s |
| F09.27 | Y2 output closed delay time | Range: 0.000~50.000s | 0.000s |
| F09.28 | Y2 output disconnected delay time | Range: 0.000~50.000s | 0.000s |
| F09.29 | Y3 output closed delay time | Range: 0.000~50.000s | 0.000s |
| F09.30 | Y3 output disconnected delay time | Range: 0.000~50.000s | 0.000s |
| F09.31 | Y4 output closed delay time | Range: 0.000~50.000s | 0.000s |
| F09.32 | Y4 output disconnected delay time | Range: 0.000~50.000s | 0.000s |
| F09.33 | Relay output closed delay time | Range: 0.000~50.000s | 0.000s |
| F09.34 | Relay output disconnected delay time | Range: 0.000~50.000s | 0.000s |

Parameter F09.25 ~ F09.34 defines the corresponding delay time from connect or disconnect to frequency level of the multifunction output terminals. Table 7-30 is the schematic of multi-function output terminal operation.

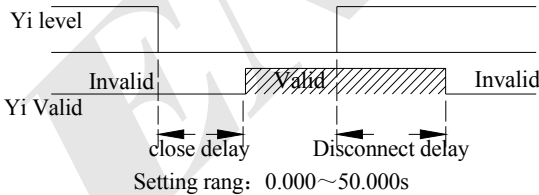

Fig.7-30 Multifunction output terminal action diagram

| | | | |
|--------|--------------------------------------|-------------|---|
| F09.35 | Analog output (AO1) selecting | Range: 0~25 | 0 |
| F09.36 | Analog output (AO2) selecting | Range: 0~25 | 0 |
| F09.37 | DO function selecting(reuse with Y4) | Range: 0~25 | 0 |

0:output frequency before slip compensation(0.00Hz~ upper limit frequency)

1:output frequency after slip compensation(0.00Hz~ upper limit frequency)

2: setup frequency(0.00Hz~ upper limit frequency)

3:master setup frequency(0.00Hz~ upper limit frequency)

4:auxiliary setup frequency(0.00Hz~ upper limit frequency)

5:current output 1(0~2×rated current of frequency inverter)

6:current output 1(0~3×rated current of frequency inverter)

7:output voltage(0~1.2×rated voltage of load motor)

8: bus voltage (0~1.5×Rated bus voltage)

9:motor speed(0~3 ×rated speed)

10:PID given(0.00~10.00V)

11:PID feedback(0.00~10.00V)

12:AI1(0.00~10.00V or 4~20mA)

13:AI2(-10.00~10.00V or 4~20mA)

14: communication given(AO output is controlled by communication, please refer to the related communication protocol for details.)

15:motor rotate speed (0.00Hz~upper limit frequency)

16:current given torque (0~2 times of rated torque)

17:current output torque(0~2 times of rated torque)

18:current torque current(0~2 times of rated motor current)

19:current flux current(0~1 times of rated motor flux current)

20~25:Reserved

1.Terminal AO1 and AO2 are optional output terminal of 0~10V or 4~20mA which can satisfy the variety needs of customer.

2.By disposing F00.21 analog output, output of terminal AO1 and AO2 can be 0~10V or 4~20mA to satisfy the variety needs of customer.

3.The unit's place of F00.22 is set to 1 when DO output pulse signal.

4.Rated flux current=current value of F15.11 parameter.

Rated torque current=sqrt (rated motor current×rated motor Current-rated flux current×rated flux current)



Note

| | | | |
|--------|----------|--|--|
| F09.38 | Reserved | | |
|--------|----------|--|--|

| | | | |
|--------|---------------------------------|-------------------|------|
| F09.39 | Analog output (AO1) filter time | Range: 0.0~20.0s | 0.0s |
| F09.40 | Analog output (AO1) gain | Range: 0.00~2.00 | 1.00 |
| F09.41 | Analog output (AO1) bias | Range: 0.0~100.0% | 0.0% |

Parameter F09.39 defines the filter time of A01 output, its reasonable setting can improve stability of analog output. But a higher setting will influence the rate of

change, which can not reflect the instantaneous value of corresponding physical quantity.

If users want to change the display range or error correction table headers, you can achieve it by adjusting the output gain and bias of AO1.

When AO1 output voltage, the adjustment is as follows:

Analog output AO1(after revise)=output gain(F09.40)×analog output AO1(before revise)+output bias(F09.41)×10V

When AO1 output current, the adjustment is as follows:

Analog output AO1(after revise)=output gain(F09.40)×analog output AO1(before revise)+output bias(F09.41)×20mA



Note

This function code will influence analog output during modify processes.

| | | | |
|---------------|--|--------------------------|-------------|
| F09.42 | Analog output (AO2) filter time | Range: 0.0~20.0s | 0.0s |
| F09.43 | Analog output (AO2) gain | Range: 0.00~2.00 | 1.00 |
| F09.44 | Analog output (AO2) bias | Range: 0.0~100.0% | 0.0% |

Please refer to the function introduce of parameters F09.39~F09.41

| | | | |
|---------------|--|---------------------------|----------------|
| F09.45 | DO filter time | Range: 0.0~20.0s | 0.0s |
| F09.46 | DO output gain | Range: 0.00~2.00 | 1.00 |
| F09.47 | DO maximum pulse output frequency | Range: 0.1~20.0KHz | 10.0KHz |

Please refer to the function introduce of parameters F09.39~F09.41.

Maximum pulse output frequency of terminal DO corresponds to maximum select value of F09.37. For example, F09.31=0, terminal DO's function is: output frequency before slip compensation, which means Maximum pulse output frequency corresponds to upper frequency.

Note: When the output frequency of DO port is less than 1.5Hz, disposed as 0Hz.

| | | | |
|---------------|---|----------------------------|--------------|
| F09.48 | Torque reaches to the detection time | Range: 0.02~200.00s | 1.00s |
|---------------|---|----------------------------|--------------|

| | | | |
|---------------|-----------------|--|--|
| F09.49 | Reserved | | |
| F09.50 | Reserved | | |

7.11 Simple PLC/Multi-speed function parameters Group:F10

| | | | |
|---------------|-----------------------------------|---|-------------|
| F10.00 | Simple PLC operate setting | Range: unitdigit: 0~3 tens digit: 0~2 hundreds digit: 0,1 thousands digit: 0,1 | 0000 |
|---------------|-----------------------------------|---|-------------|

The simple PLC operation mode, re-start mode after interruption, unit of running time and the storage mode when power off can be set in different bit of parameter F10.00, details as follows:

Unit digit: simple PLC operation mode.

0:**No action.**PLC operation mode is disabled.

1:**Stop after single cycle.** as show in Fig.7-31, the drive stops automatically after one cycle of operation and will not start only when receiving RUN command again.

2: Maintain final value after one cycle, as show in Fig.7-32, the drive will keep running with the final value and the direction after complete one cycle operation, the drive won't stop according to the set stop mode until the stop command is available.

3: Continuous operation, as show in Fig.7-33, the drive will start next cycle of operation automatically after completing one cycle of operation until receiving STOP command then stop according to the set stop mode.

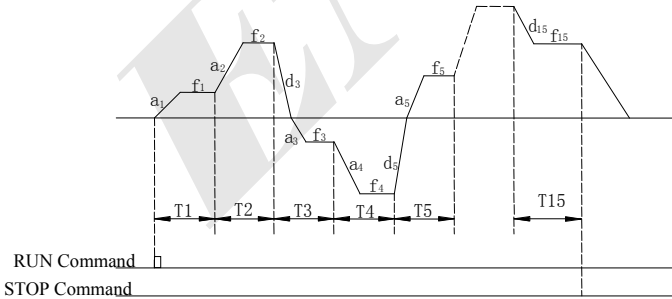

Fig.7-31 PLC stop operating after one cycle mode

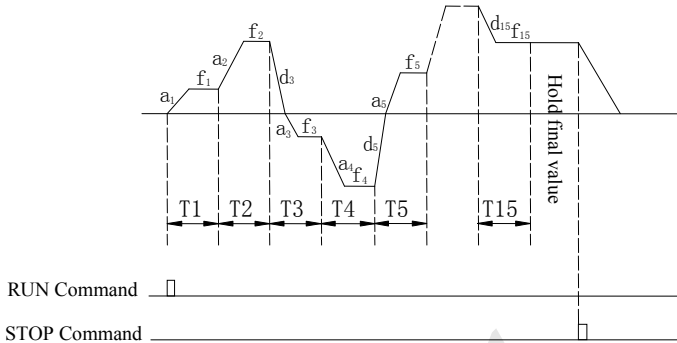

Fig.7-32 PLC holds the final value after one cycle mode

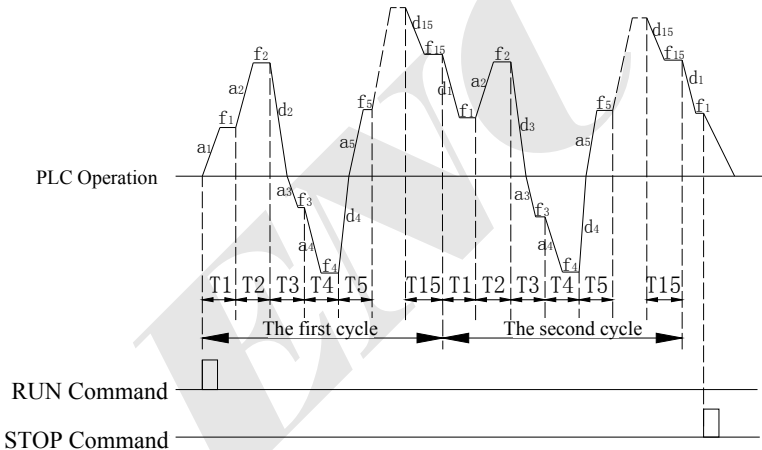

Fig7-33 PLC continuous operation mode

a1~a15: The Acc time of different steps

d1~d15: The Dec time of different steps

f1~f15: The frequency of different steps

There are 15 steps can set in Fig.7-31, 7-32, 7-33.

Tens digit: Restart mode after interruption.

0: Restart from the first step.

If the drive stops during PLC operation due to receiving STOP commands, fault alarm or power failure, it will run from the first step after restarting.

1: Restart from the interruption step;

If the drive stops during PLC operation due to receiving STOP command or fault

alarm, the drive will record the operating time of the current step and will continue from the step where the drive stops after restart at the frequency defined for this step with the remained time, as show in Fig.7-34.If the drive stops due to power off, it will not record the state and from the first step operate when restart.

2: Restart from the interrupted Frequency

If the drive stops during PLC operation due to receiving STOP command or fault alarm, the drive will record the operating time and the current frequency of the interrupt step, it will operating with the record time and record frequency when restart, as show in Fig7-35

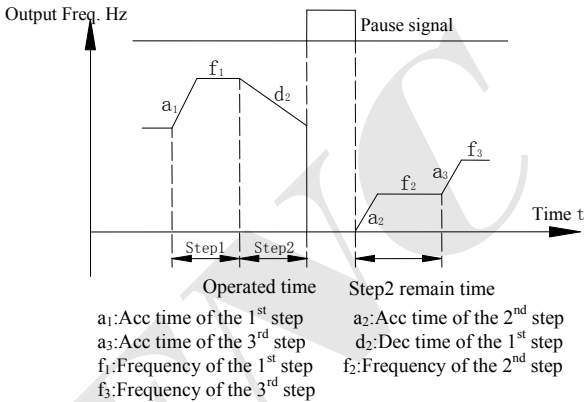

Fig.7-34 simple PLC restart mode 1

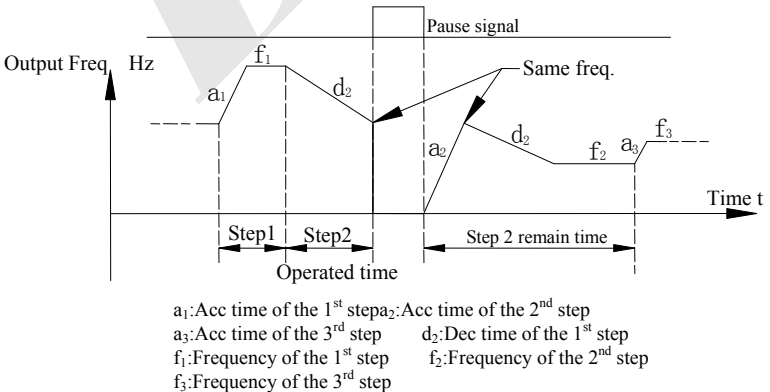

Fig.7-35 PLC Restart mode 2

Hundreds digit: PLC unit of running time.

0: Seconds;

1: Minutes;

The unit is effective for the running time of different steps only, during the operation of PLC, the unit of Acc time and Dec time is defined by parameter F01.19.



Note

1. The step is ineffective if the time of this step of PLC operation is set as 0 thereafter operate the next step.

2. Control the PLC process a pause ,ineffective, operate via terminal ,for details please refer to parameters in F8 Group that relative with terminal function.

Thousands digit: the storage mode when power off.

0: No storage. No record the running state when power off, it will restart from the first step when power on again.

1: Storage. Records the running status which include the step, running frequency and running time when power off, it restart with the mode that set in hundreds digit after power on again.



Note

No matter power-off storage in stop status or running status, you should set thousands digit as 1 thereafter set tens digit as 1 or 2,otherwise power-off storage function is ineffective.

| | | | |
|--------|-----------------|------------------|-----|
| F10.01 | Step 1 setting | Range: 000H~E22H | 020 |
| F10.02 | Step 2 setting | Range: 000H~E22H | 020 |
| F10.03 | Step 3 setting | Range: 000H~E22H | 020 |
| F10.04 | Step 4 setting | Range: 000H~E22H | 020 |
| F10.05 | Step 5 setting | Range: 000H~E22H | 020 |
| F10.06 | Step 6 setting | Range: 000H~E22H | 020 |
| F10.07 | Step 7 setting | Range: 000H~E22H | 020 |
| F10.08 | Step 8 setting | Range: 000H~E22H | 020 |
| F10.09 | Step 9 setting | Range: 000H~E22H | 020 |
| F10.10 | Step 10 setting | Range: 000H~E22H | 020 |
| F10.11 | Step 11 setting | Range: 000H~E22H | 020 |
| F10.12 | Step 12 setting | Range: 000H~E22H | 020 |

| | | | |
|---------------|------------------------|-------------------------|------------|
| F10.13 | Step 13 setting | Range: 000H~E22H | 020 |
| F10.14 | Step 14 setting | Range: 000H~E22H | 020 |
| F10.15 | Step 15 setting | Range: 000H~E22H | 020 |

F10.01~F10.15 are used to configure the operating frequency, direction and Acc/Dec time of each PLC operating step. These functions are all selected by digits on different place of parameters. Details as below:

Unit digit: Frequency setting

0:select multi-frequency i. i=1~15,please refer to F10.31~F10.45 for definitions of multi-frequency.

1:the frequency is determined by the combination of the main frequency and the auxiliary frequency.

2: Reserved.

Tens digit: The selection of running direction for PLC and multi-speed.

0: Forward.

1: Reversed.

2: Determined by operating commands (FWD, REV)

Hundreds digit: Acc/Dec time choose

0: Acc/Dec time 1

1: Acc/Dec time 2

2: Acc/Dec time 3

3: Acc/Dec time 4

4: Acc/Dec time 5

5: Acc/Dec time 6

6: Acc/Dec time 7

7: Acc/Dec time 8

8: Acc/Dec time 9

9: Acc/Dec time 10

A: Acc/Dec time 11

B: Acc/Dec time 12

C: Acc/Dec time 13

D: Acc/Dec time 14

E: Acc/Dec time 15

Accelerate time1~15 defined by F01.17,F01.18,F04.16~F04.43. The running direction of PLC and multi-speed is determined by the ten's place of F10.01~F10.15.

| | | | |
|---------------|----------------------------|------------------------|-------------|
| F10.16 | Step 1 running time | Range: 0~6000.0 | 10.0 |
| F10.17 | Step 2 running time | Range: 0~6000.0 | 10.0 |

| | | | |
|--------|----------------------|-----------------|------|
| F10.18 | Step 3 running time | Range: 0~6000.0 | 10.0 |
| F10.19 | Step 4 running time | Range: 0~6000.0 | 10.0 |
| F10.20 | Step 5 running time | Range: 0~6000.0 | 10.0 |
| F10.21 | Step 6 running time | Range: 0~6000.0 | 10.0 |
| F10.22 | Step 7 running time | Range: 0~6000.0 | 10.0 |
| F10.23 | Step 8 running time | Range: 0~6000.0 | 10.0 |
| F10.24 | Step 9 running time | Range: 0~6000.0 | 10.0 |
| F10.25 | Step 10 running time | Range: 0~6000.0 | 10.0 |
| F10.26 | Step 11 running time | Range: 0~6000.0 | 10.0 |
| F10.27 | Step 12 running time | Range: 0~6000.0 | 10.0 |
| F10.28 | Step 13 running time | Range: 0~6000.0 | 10.0 |
| F10.29 | Step 14 running time | Range: 0~6000.0 | 10.0 |
| F10.30 | Step 15 running time | Range: 0~6000.0 | 10.0 |

Parameters F10.16~F10.30 defined Running time of each PLC Step from Step 1 to Step 15.



Each step running time include Acc time and Dec time.

Note

| | | | |
|--------|--------------------|--------------------------------|---------|
| F10.31 | Multi-Frequency 1 | Range:0.00Hz~upper limit Freq. | 5.00Hz |
| F10.32 | Multi-Frequency 2 | Range:0.00Hz~upper limit Freq. | 10.00Hz |
| F10.33 | Multi-Frequency 3 | Range:0.00Hz~upper limit Freq. | 20.00Hz |
| F10.34 | Multi-Frequency 4 | Range:0.00Hz~upper limit Freq. | 30.00Hz |
| F10.35 | Multi-Frequency 5 | Range:0.00Hz~upper limit Freq. | 40.00Hz |
| F10.36 | Multi-Frequency 6 | Range:0.00Hz~upper limit Freq. | 45.00Hz |
| F10.37 | Multi-Frequency 7 | Range:0.00Hz~upper limit Freq. | 50.00Hz |
| F10.38 | Multi-Frequency 8 | Range:0.00Hz~upper limit Freq. | 5.00Hz |
| F10.39 | Multi-Frequency 9 | Range:0.00Hz~upper limit Freq. | 10.00Hz |
| F10.40 | Multi-Frequency 10 | Range:0.00Hz~upper limit Freq. | 20.00Hz |
| F10.41 | Multi-Frequency 11 | Range:0.00Hz~upper limit Freq. | 30.00Hz |

| | | | |
|---------------|---------------------------|---------------------------------------|----------------|
| F10.42 | Multi-Frequency 12 | Range:0.00Hz~upper limit Freq. | 40.00Hz |
| F10.43 | Multi-Frequency 13 | Range:0.00Hz~upper limit Freq. | 45.00Hz |
| F10.44 | Multi-Frequency 14 | Range:0.00Hz~upper limit Freq. | 50.00Hz |
| F10.45 | Multi-Frequency 15 | Range:0.00Hz~upper limit Freq. | 50.00Hz |

Frequency will be used in Multi-speed operation mode and Simple PLC operation mode. More details please refer to the Multi-speed terminal operation function in Parameters Group F08 and Simple PLC operation function in Parameters Group F10.

7.12 Closed-Loop PID operation Parameters Group:F11

Analog feedback control system:

Pressure reference is input through the terminal AI1, and water pressure sensor send a 4-20mA to the terminal AI2 of inverter as a feedback signal, all of them make up of analog closed-loop control system via build-in PID adjuster ,as shown in Fig.7-36

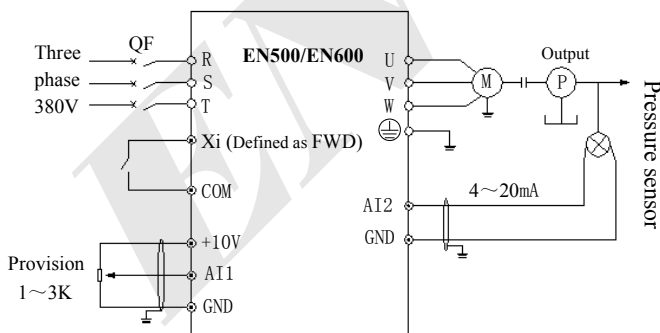

Fig.7-36 Build-in PID adjuster control system diagram



Setting the value of F11.01 can choose the channel of pressure reference.

Operating principle of built-in PID function of EN500/EN600 is shown in Fig.7-37 as below:

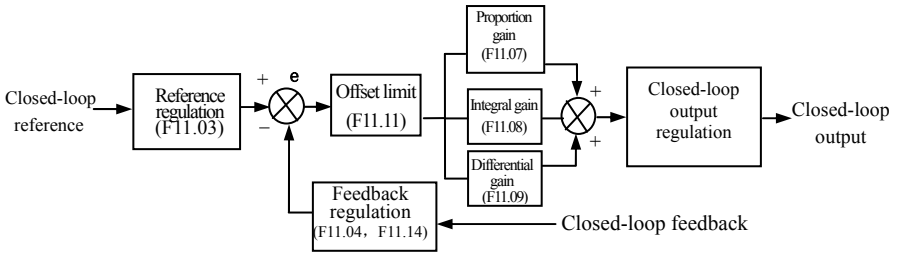

Fig.7-37 PID block control principle diagram

In above diagram ,the definition of closed-loop reference ,feedback error limit and PI parameters are similar with the general PID adjuster, the relationship between reference and expected feedback is shown in Fig.7-38.The reference and feedback are converted and based on 10.00V.

In Fig.7-37, the real values of closed-loop reference and feedback can be regulated in Group F06 and F07, so that can reach a good performance.

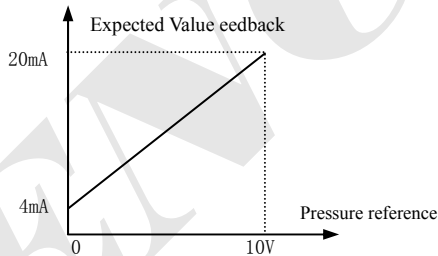

Fig.7-38 Reference and expected feedback value

After the system control mode is confirmed, follow the procedures below to set the closed-loop parameters:

- (1) Determine the closed-loop reference and feedback channel (F11.01~F11.02).
- (2) The relationship between the closed-loop reference and feedback should be defined for closed-loop control (the Group F6).
- (3) Set up the closed-loop frequency presetting function (F11.19,F11.20).
- (4) Adjust the proportion gain, integral gain, differential gain, sampling cycle and error limit(F11.07~F11.11).

| | | | |
|---------------|-------------------------------------|-------------------|----------|
| F11.00 | Closed-loop control function | Range: 0,1 | 0 |
|---------------|-------------------------------------|-------------------|----------|

0:PID closed-loop function disabled

1:PID closed-loop function enabled

| | | | |
|---------------|---------------------------------|-------------------|----------|
| F11.01 | Reference channel choose | Range: 0~7 | 0 |
|---------------|---------------------------------|-------------------|----------|

0: Digital provision**1:AI1 analog 0-10V or 4-20mA provision****2:AI2 analog provision****3:EAI1 analog provision (Extensible)****4:EAI2 analog provision (Extensible)****5: Pulse provision**

6: Communication provision(Communication address: 1D00). Please refer to the chapter of Modbus communication.

7: Reserved**Note**

Except the above provision channels, Multi-Closed-loop provision is available. Connecting different terminal to choose different provision value which with a highest priority.

| | | | |
|---------------|-----------------------------------|-------------------|----------|
| F11.02 | Feedback channel selection | Range: 0~9 | 0 |
|---------------|-----------------------------------|-------------------|----------|

0:AI1 analog input**1:AI2 analog input****2:EAI1 analog input(Extensible)****3:EAI2 analog input(Extensible)****4:AI1+AI2****5:AI1-AI2****6:Min {AI1, AI2}****7:Max {AI1, AI2}****8: Pulse input****9:Communication feedback (address is 1DOC, 4000 stands for 10.00V)**

| | | | |
|---------------|---|---------------------------|--------------|
| F11.03 | Provision channel filtering time | Range: 0.00~50.00s | 0.20s |
| F11.04 | Feedback channel filtering time | Range: 0.00~50.00s | 0.10s |
| F11.05 | PID output filtering time | Range: 0.00~50.00s | 0.10s |

The external reference signal and feedback signal usually carry some noise. those noise signal can be filtered by setting the time constant of filter in F11.03 and F11.04.The bigger the time constant is, the better the immunity capability, but with a slow response. The shorter the time constant is, the faster the response, but the immunity capability became weak.

The PID output filter time is the time of the filter for output frequency or torque, the bigger time, the slower the response output.

| | | | |
|---------------|----------------------------------|---------------------------|--------------|
| F11.06 | Provision digital setting | Range: 0.00~10.00V | 1.00V |
|---------------|----------------------------------|---------------------------|--------------|

This function can realize digital setting of reference via keypad.



Note

When the PID function is enabled, Setting F18.14 as 1 can adjust pressure reference by press \wedge \vee , otherwise the \wedge \vee keys are invalid for adjusting reference in monitoring mode.

| | | | |
|---------------|-----------------------------|----------------------------|---------------|
| F11.07 | Proportion Gain Kp | Range: 0.000~6.5535 | 0.0500 |
| F11.08 | Integral Gain Ki | Range: 0.000~6.5535 | 0.0500 |
| F11.09 | Differential Gain Kd | Range: 0.000~9.999 | 0.000 |
| F11.10 | Sampling cycle T | Range: 0.01~1.00s | 0.10s |

The bigger of the proportion gain of Kp, the faster the response, but oscillation may easily occur.

If only proportion gain Kp is used in regulation, the offset cannot be eliminated completely. To eliminate the offset, please use the integral gain Ki to form a PI control system. The bigger Ki is, the faster the response, but oscillation may easily occur if Ki is big enough.

The sampling cycle T refers to the sampling cycle of feedback value. The PI D regulator calculates once in each sampling cycle. The bigger the sampling cycle is, the slower the response.

| | | | |
|---------------|------------------------|-------------------------|-------------|
| F11.11 | Deviation limit | Range: 0.0~20.0% | 2.0% |
|---------------|------------------------|-------------------------|-------------|

It defines the max. Deviation of the output from the reference, as shown in Fig.7-39, the PID adjuster stops operation when the feedback value within this range. Setting this parameter correctly will improve the moderation of the accuracy and stability of the system

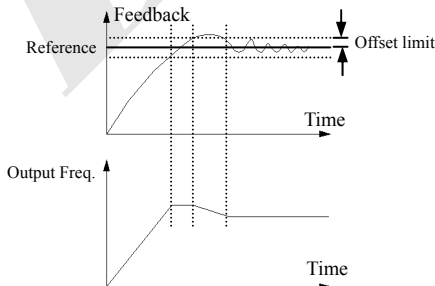

Fig.7-39 Offset limit



Note

Offset limit is the percentage refer to the value of reference.

| | | | |
|---------------|---|----------------------------|--------------|
| F11.12 | PID differential amplitude limit | Range: 0.00~100.00% | 0.10% |
|---------------|---|----------------------------|--------------|

In the PID regulator, the effect of differential is too sensitive too easy to cause system oscillation, therefore limit the effect of differential PID in a smaller range, F11.12 the parameter that used to set the output range of PID differential.

| | | | |
|---------------|--|-------------------|----------|
| F11.13 | Closed-loop regulation characteristic | Range: 0,1 | 0 |
|---------------|--|-------------------|----------|

0: Positive effect. When the provision increases, select while requiring speed of motor increase.

1: Negative effect. When the provision increases, select while requiring speed of motor decrease.

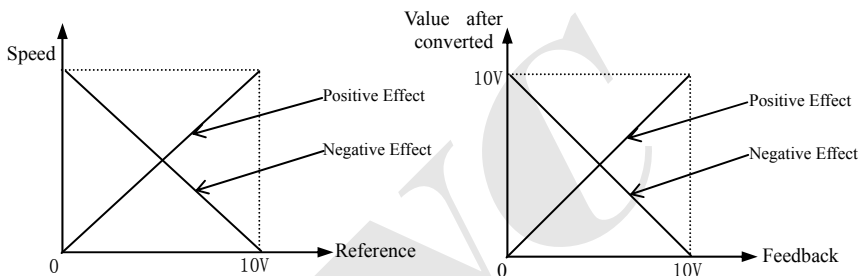

Fig.7-40 Closed-loop characteristic

Fig.7-41 Feedback characteristic

| | | | |
|---------------|--|-------------------|----------|
| F11.14 | Feedback channel positive-negative characteristic | Range: 0,1 | 0 |
|---------------|--|-------------------|----------|

0: Positive characteristic. The relationship between reference and feedback is positive

1: Negative characteristic. The relationship between reference and feedback is negative

This parameter is used to change the feedback characteristic of the feedback signal. After input into inverter through the feedback channel, the feedback pressure will compare with the reference after regulated by the positive and negative characteristic regulation, as shown in Fig.7-41

| | | | |
|---------------|---|--|----------------|
| F11.15 | PID regulation upper limit frequency | Range: 0.00Hz~upper limit Frequency | 50.00Hz |
| F11.16 | PID regulation lower limit frequency | Range: 0.00Hz~upper limit Frequency | 0.00Hz |

User can set up the parameters F11.15 and F11.16 to define the output lower limit and upper limit frequency of the PID regulator.

| | | | |
|---------------|--------------------------------------|-------------------|----------|
| F11.17 | Integral regulation selection | Range: 0,1 | 0 |
|---------------|--------------------------------------|-------------------|----------|

0: Stop integral regulating when the comparison value of the reference and

feedback reaches the range of threshold for integral separation

1: Keep integral regulating even though the comparison value of the reference and feedback reach the range of threshold integral separation
Adjusting this parameter can avoid integral saturation and improve the response of the system.

| | | | |
|---------------|---|--------------------------|---------------|
| F11.18 | PID threshold of the integral separation | Range: 0.0~100.0% | 100.0% |
|---------------|---|--------------------------|---------------|

PID integral separated function: there is no integral regulating just proportion regulating during closed-loop control when the comparison value that between reference and feedback is bigger than this threshold. When the comparison is smaller than this threshold, the integral regulating will be active, and can adjust the response speed of system by adjusting this parameter.

| | | | |
|---------------|---|--|---------------|
| F11.19 | Preset Closed-loop frequency | Range: 0.00Hz~upper limit frequency | 0.00Hz |
| F11.20 | Holding time of preset Closed-loop frequency | Range: 0.0~6000.0s | 0.0s |

This function can make the closed-loop adjuster into the stable status quickly.

When the closed-loop function start, the output frequency will ramp up to the preset closed-loop frequency(F11.19) within the Acc time, and keep running the time that set in F11.20 then start the closed-loop operation as shown is Fig.7-42

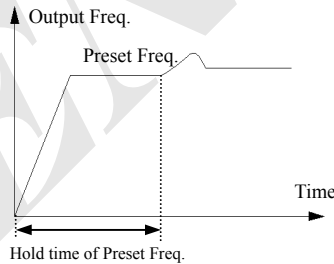

Fig.7-42 Preset closed-loop operating



Note

Preset closed-loop Function is ineffective when set F11.19 and F11.20 as 0.

| | | | |
|---------------|---|-------------------|----------|
| F11.21 | Closed-loop output reversion selection | Range: 0~2 | 2 |
|---------------|---|-------------------|----------|

0: The inverter will runs with the low limit frequency when the closed-loop output value is negative

1:The inverter will reverse running when the value of the closed-loop output is negative (be opposite of the initial direction)

2: determined by running demand. The motor running direction is determined by demand direction.



Note

The comparison value can be display in the PID monitor parameters, it's positive when the reference bigger than the feedback value, and negative when reference smaller than feedback value.

| | | | |
|---------------|---|--|----------------|
| F11.22 | Closed-loop output reversion frequency upper limit | Range: 0.00Hz~upper limit Frequency | 50.00Hz |
|---------------|---|--|----------------|

The PID regulator is a kind of bipolar adjustment. By setting F11.21 and F11.22, can choose whether the inverter reverse run in some degree frequency or not.

| | | | |
|---------------|---|---------------------------|--------------|
| F11.23 | Multiple closed-loop provision 1 | Range: 0.00~10.00V | 0.00V |
| F11.24 | Multiple closed-loop provision 2 | Range: 0.00~10.00V | 0.00V |
| F11.25 | Multiple closed-loop provision 3 | Range: 0.00~10.00V | 0.00V |
| F11.26 | Multiple closed-loop provision 4 | Range: 0.00~10.00V | 0.00V |
| F11.27 | Multiple closed-loop provision 5 | Range: 0.00~10.00V | 0.00V |
| F11.28 | Multiple closed-loop provision 6 | Range: 0.00~10.00V | 0.00V |
| F11.29 | Multiple closed-loop provision 7 | Range: 0.00~10.00V | 0.00V |

Among the closed-loop reference channel, besides the 7 channels defined by F11.01, the closed-loop reference can also be defined in F11.23~F11.29. The priority of multi-closed-loop reference control is higher than the reference channels that defined by F11.01.

Multi-closed-loop reference 1~7 can be selected by external terminals. Please refer to the terminal function 19~21 of introductions to F08.18~F08.25. When the function of Constant water supply is enable, the reference of constant water pressure is decided by the multi-closed-loop reference which selected by external terminals.

Computational formula: constant pressure reference = $F12.06 \times \text{Multi-closed-loop reference} / 10.00V$. By using this functions can realize different times with a different constant water pressure.

7.13 Constant pressure water supply function parameters Group: F12

| | | | |
|---------------|--|-------------------|----------|
| F12.00 | Constant pressure water supply mode selection | Range: 0~5 | 0 |
|---------------|--|-------------------|----------|

0: disabled.

1: Inverter works in one-drive-two-pump mode.

2: Choose extensible constant pressure board acts in one-drive-two-pump mode.

3: Choose extensible constant pressure board acts in one-drive-three-pump mode.

4: Choose extensible constant pressure board acts in one-drive-four-pump mode.

5: Select inverterY1,Y2 as the double pump timing alternate constant pressure water supply mode. While F12.00=5,F09.00=37,F09.01=38, realize the timing alternate constant pressure water supply control between two pumps, only one motor is running at most at any time, the time of timing alternate is defined by F12.10. While F12.10=0, no alternate control, While F12.10=1, switch a running pump while starting.

This function can be used to choose different kinds of constant pressure water supply mode, and you should choose an extensible constant pressure board to realize one-drive-three mode and one-drive-four mode and F00.19 should be set to 2.

When modify F12.00 from 0 to water supply mode is valid, C-04,C-05 automatically relate constant pressure water supply setting pressure and feedback pressure (including the display of halting and running).



1. The function of Group F11 will be effective automatically when the constant pressure supply function is enabled.
2. Except for the related parameters in Group F11 and F12 for Closed-loop, the function of Yi should be enabled in F9 for the inverter works in one-drive-two-pump mode without an extend board.
3. Output terminal Y4/DO should be set to Y4.
4. When one inverter drive one pump with constant pressure water supply, the parameter F09.00~F09.03 (Y1~Y4) can not be set 37~38.

| | | | |
|---------------|--------------------------------|--|-----------------|
| F12.01 | Target pressure setting | Range: 0.000~the range of long-distance manometer | 0.200Mpa |
|---------------|--------------------------------|--|-----------------|

This parameter defined the target pressure of the constant pressure supply system. The channels of the pressure reference and feedback are defined by F11.01 and F11.02.

| | | | |
|---------------|-----------------------------------|--|-----------------|
| F12.02 | Sleep frequency threshold | Range: 0.00Hz~upper limit frequency | 30.00Hz |
| F12.03 | Revival pressure threshold | Range: 0.000~F12.06 Mpa | 0.150Mpa |

The function of Sleep frequency threshold: To save energy and protect the motor, when the water feedback pressure within the offset limit (F11.11), and the operating frequency is under in the sleep frequency threshold (F12.02), after a sleep delay time (F12.04), the system will enter a sleep mode and the operating frequency will drop to 0.00Hz

Revival function: When the system is in the sleep mode, if the feedback water pressure keep less than F12.03 (the revival pressure) a delay time (F12.05), the system will revival from the sleep mode.

| | | | |
|---------------|-------------------------|---------------------------|-------------|
| F12.04 | Sleep delay time | Range: 0.0~6000.0s | 0.0s |
|---------------|-------------------------|---------------------------|-------------|

This parameter is the delay time that from the feedback pressure meets the sleep conditions to the system enter in sleep mode.

Within the sleep delay time, if the feedback pressure does not meet the sleep conditions, the system will not enter into sleep mode

Sleep function is disabled when F12.04=0.

| | | | |
|---------------|---------------------------|---------------------------|-------------|
| F12.05 | Revival delay time | Range: 0.0~6000.0s | 0.0s |
|---------------|---------------------------|---------------------------|-------------|

When the constant pressure supply system in the sleep state, if the feedback pressure of system less than F12.11 which defined the revival pressure threshold ,the system will revival and get out of sleep mode after the revival delay time.

| | | | |
|---------------|---|------------------------------|-----------------|
| F12.06 | The range of long-distance manometer | Range: 0.001~9.999Mpa | 1.000Mpa |
|---------------|---|------------------------------|-----------------|

This parameter defines the range of long-distance manometer. Setting this parameter can correspond to the maximum feedback pressure with the analog feedback signal 10V or 20mA

| | | | |
|---------------|--|--------------------------|-------------|
| F12.07 | Allowed deviation of upper limit frequency or lower limit frequency when add or reduce pump | Range: 0.1~100.0% | 1.0% |
|---------------|--|--------------------------|-------------|

When output frequency reaches the deviation range of upper limited frequency and the feedback is less than given value, adding pumps judge is available. When output frequency reaches the deviation range of lower limited frequency and the feedback is more than given value, decreasing pumps judge is available.

When F12.07=0.0%, output frequency reach upper or lower limitation frequency and the pressure meets the requirement, then decrease pumps is available.

| | | | |
|---------------|---|--------------------------|-------------|
| F12.08 | Add pump switching estimate time | Range: 0.2~999.9s | 5.0s |
|---------------|---|--------------------------|-------------|

When the output frequency up to the upper limit frequency (F11.15) but the pressure still not meeting the requirement, the system will add pump after the judging time.

When the output frequency down to the lower limit frequency (F11.16) but the pressure still not meeting the requirement, the system will reduce pump after the judging time.

| | | | |
|---------------|---|-------------------------|-------------|
| F12.09 | Electromagnetic contactor switching delay time | Range: 0.1~10.0s | 0.5s |
|---------------|---|-------------------------|-------------|

This parameter defines the action delay time of magnetic control conductor when it's switch from power source supply to variable or from variable frequency control to power source supply.

| | | | |
|---------------|--|---------------------------------|----------|
| F12.10 | Automatic switching time interval | Range: 0000~65535 minute | 0 |
|---------------|--|---------------------------------|----------|

By setting this parameter can avoid the rust of motor when it's not work long time. The inverter will switch the work status of the working pump and static pump automatically and smartly under the switch interval.

The automatic switch function is disabled when set the parameter as 0000. The system will switch one time when each restart of system as this parameter is 0001. If the value of this parameter is bigger than 0002, the system will switch automatically according to the switch interval.

| | | | |
|---------------|-------------------------------|-------------------|----------|
| F12.11 | Revival mode selection | Range: 0,1 | 0 |
|---------------|-------------------------------|-------------------|----------|

| | | | |
|---------------|-------------------------------------|-------------------------|-------------|
| F12.12 | Revival pressure coefficient | Range: 0.01~0.99 | 0.75 |
|---------------|-------------------------------------|-------------------------|-------------|

When F12.11=0, the revival pressure of the constant pressure supply is the value of F12.03.

When F12.11=1, the revival pressure is the calculating value of $F12.12 * F12.01$

| | | | |
|---------------|--|--------------------------|-------------|
| F12.13 | Reduce pump switching estimate time | Range: 0.2~999.9s | 5.0s |
|---------------|--|--------------------------|-------------|

When the output frequency up to the upper limit frequency (F11.15)but the pressure still not meeting the requirement, the system will add pump after the judging time defined by F12.08.

When the output frequency down to the lower limit frequency (F11.15) but the pressure still not meeting the requirement, the system will reduce pump after the judging time defined by F12.13.

| | | | |
|---------------|-----------------|--|--|
| F12.14 | Reserved | | |
|---------------|-----------------|--|--|

7.14 Traverse, Fixed-length control Function Parameters Group: F13

| | | | |
|---------------|------------------------------------|-------------------|----------|
| F13.00 | Traverse function selection | Range: 0,1 | 0 |
|---------------|------------------------------------|-------------------|----------|

0: Disabled

1: Enabled

| | | | |
|---------------|--------------------------------|--|-------------|
| F13.01 | Traverse operating mode | Range: unit digit: 0,1 tens digit: 0,1 hundreds digit: 0,1 thousands digit: 0,1 | 0000 |
|---------------|--------------------------------|--|-------------|

Unit digit: Start mode 1st

0: Auto start. The drive operates at the preset frequency of traverse for a certain time thereafter enter traverse mode automatically.

1: Terminal manual mode. Choosing multi-function terminal($X_i = X_1 \sim X_8$) as 56 function, when the terminal is enabled, the drive will enter traverse mode. The drive will exit traverse operation and operate at the pre-set traverse frequency when it's disabled.

Tens digit: Traverse amplitude AW mode choosing

0: Variable swing. Amplitude AW changes with the central frequency and the change rate relate to the definition of F13.02.

1: Fixed swing. Traverse operating amplitude AW is determined by Upper limit Frequency and F13.02.

Note: The traverse central frequency is set by the main frequency.

Hundreds digit: Restart mode

0: Restart at the initial state.

1: Restart at the memorized state before stopping

Thousands digit: Traverse state saving when power off.

This function is effective when the start mode is Restarting from the reserved memory state, and saving operating state when power off.

0: Not save

1: Save



Note

When in variable amplitude mode, the channel of central frequency is confirmed by F01.06. During the traverse frequency operation, the Acc and Dec time are controlled only by traverse frequency circle F13.04 when adjusting the central frequency.

| | | | |
|---------------|---------------------------------------|-------------------------|--------------|
| F13.02 | Traverse frequency swing value | Range: 0.0~50.0% | 10.0% |
|---------------|---------------------------------------|-------------------------|--------------|

Variable amplitude: $AW = \text{the central frequency} \times F13.02$

Fixed amplitude: $AW = \text{Upper limit frequency} \times F13.02$



The traverse operating frequency is restricted by the upper and lower limit of frequency. Incorrectly setting the frequency will lead to abnormal of traverse operation.

| | | | |
|---------------|------------------------------|------------------------|-------------|
| F13.03 | Sudden-jump frequency | Range:0.0~50.0% | 2.0% |
|---------------|------------------------------|------------------------|-------------|

As shown in Fig.7-43, there is not a jitter frequency when F13.03=0.

| | | | |
|---------------|-----------------------|-------------------------|--------------|
| F13.04 | Traverse cycle | Range:0.1~999.9s | 10.0s |
|---------------|-----------------------|-------------------------|--------------|

F13.04 defines a complete cycle of traverse operation which including rising and falling processed.

| | | | |
|---------------|------------------------------------|--|--------------|
| F13.05 | Triangular wave rising time | Range:0.0~98.0%(Traverse cycle) | 50.0% |
|---------------|------------------------------------|--|--------------|

Definition traverse rising time= $F13.04 \times F13.05$ (s), the traverse falling time= $F13.04 \times (1-F13.05)$ (s).

Please refer to Fig.7-43

| | | | |
|---------------|-------------------------------------|----------------------------|---------------|
| F13.06 | Preset frequency of Traverse | Range:0.00~400.00Hz | 0.00Hz |
|---------------|-------------------------------------|----------------------------|---------------|

F13.06 defines the operating frequency of the Drive before entering traverse operation.

| | | | |
|---------------|---|--------------------------|-------------|
| F13.07 | Traverse preset frequency waiting time | Range:0.0~6000.0s | 0.0s |
|---------------|---|--------------------------|-------------|

F13.07 defines the operating time of Preset frequency before entering Traverse operation when auto-start mode is enabled.

If manual start mode is available, F13.07 is disabled.

Please refer to Fig.7-43 as below.

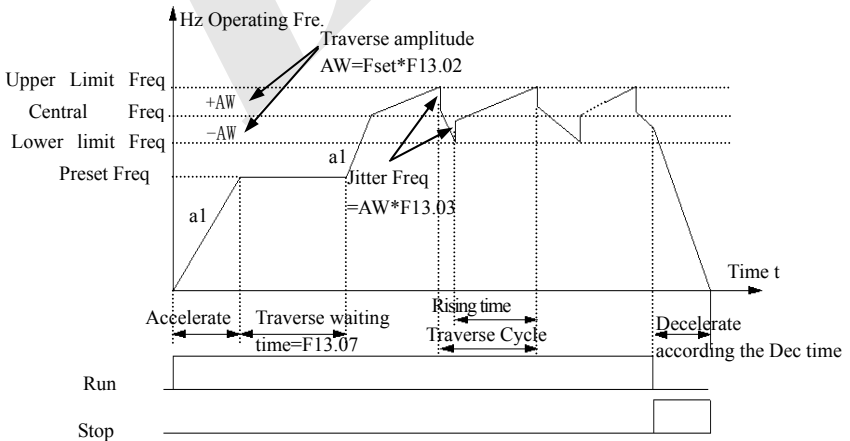

Fig.7-43 Traverse operation

| | | | |
|--------|--------------------------------|-----------------------------|---------|
| F13.08 | Setup length | Range: 0~65535 (m\cm\mm) | 0 |
| F13.09 | Pulse No. of axis per circle | Range: 1~10000 | 1 |
| F13.10 | Axis perimeter | Range: 0.01~655.35cm | 10.00cm |
| F13.11 | Percentage of remaining length | Range: 0.00%~100.00% | 0.00% |
| F13.12 | Length correction coefficient | Range: 0.001~10.000 | 1.000 |

Set length, actual length and Numbers of pulses per cycle are used for fixed length control. The Actual length is calculated by the number of pulses collected by terminal Xi (i=1--8), set the Xi function code to 62 and length signal output.

actual length=(Actual number of pulses×F13.10×F13.12)/ F13.09. When the actual record length(F00.02 = 39)>set length(F13.08), after the time defined by F13.07, The "reach length" signal can be output via Yi and the relay output terminal for 0.5 seconds.

When remaining length ratio< F13.11, The drive will run at the frequency defined by F13.06 until the length is reached. With this function, the overshoot of the stop can be prevented to increase the accuracy of the fixed length control. When this parameter equals 0.00%, this function is invalid. (This function is valid only when the current frequency is the primary auxiliary).



Note

1) When F00.02=39, Actual length can be monitored by C-01 in running state. Count length function is available both V/F control mode and Vector Control mode.

2) Using X8 port as a fixed length count input, the maximum input value is 4K. Using X1~X7 port as a fixed length count input, the maximum input value is 50Hz.

| | | | |
|--------|--|---|------|
| F13.13 | Record length when the length is reached | units digit: Reserved Tens digit: 0、1、2 Hundreds digit: 0、1、2 Thousands digit: 0、1、2 | 0000 |
|--------|--|---|------|

Units digit: Reserved

Tens digit: Sets the unit of length

0: meter (m)

1: centimeter (cm)

2: millimeter (mm)

Hundreds digit: Actions when the length is reached

0: Continue running**1: Shut down according to stopping mode****2: Loop length control**

Thousands digit: Software reset length (could be cleared by communication)

0: No operation**1: The current length is cleared****2: The current length and total length both cleared**

F13.13 tens digit determines the unit of length in F13.08, 0=m, 1=cm, 2=mm. According to the process requirements to select different units can increase the accuracy of fixed-length control.

F13.13 Hundreds digit determine the action of the drive when reach the length. 0 = Continue running, 1 = Shut down according to stopping mode, 2 = Loop length control. When 2 is selected, the frequency will run for 0 frequency and continue for the next fixed time after the time defined by F13.04. This function is effective only when the frequency is the main auxiliary reference, for example jogging, PLC, process PID. This function is only available when the reference of a higher priority is invalid.

F13.13 Thousands digit: The upper computer can change the current length and the cumulative length by changing thousands digit of F13.13. Note that F13.13 can not be wrongly modify the other bits, such as F13.13 units, tens, hundreds were 1,1,0, then F13.13 should be set to 0x1110 or 0x2110. When the multi-function input terminal No. 63 is valid, both the current length and the accumulated length are cleared.

| | | | |
|--------|----------------------------------|---|------------|
| F13.14 | Record length at shutdown | Units digit: 0、1 Tens digit: 0、1 Hundreds digit: 0、1 | 011 |
|--------|----------------------------------|---|------------|

Units digit: Stops the current length

0: Automatically cleared

The current record length is automatically cleared at shutdown.

1: Length is maintained

The current record length remains unchanged during shutdown.

Tens digit: Power-down length memory setting

0: Not stored**1: Stored**

This digit controls the current length of the power-down storage feature, but the cumulative length of the power-down will be stored.

Hundreds digit: length calculation at shutdown

0: The length is not calculated**1: Calculate the length**

When this digit is 1, the length calculation module will automatically calculate the length according to the external pulse when the inverter is shutdown.

7.15 Vector Control parameters Group: F14

| | | | |
|---------------|---------------------------------------|-------------------|----------|
| F14.00 | Speed/Torque control selection | Range: 0,1 | 0 |
|---------------|---------------------------------------|-------------------|----------|

0: Speed control mode

1: Torque control mode (this parameter is effective when set F00.24 as 1 or 2).

When the control mode is vector control with PG or without PG, the user can select torque control or speed control by setting the parameter of F14.00 or through control multi-function terminal which selected as No.65 function.

| | | | |
|---------------|---|---|---------------|
| F14.01 | Speed loop high speed proportional Gain | Range:0.1~40.0(Valid when F00.24=1 or 2) | 20.0 |
| F14.02 | Speed loop high speed integral time | Range:0.001~10.000s(Valid when F00.24=1 or 2) | 0.040s |
| F14.03 | Speed loop low speed proportional Gain | Range:0.1~80.0(Valid when F00.24=1 or 2) | 20.0 |
| F14.04 | Speed loop low speed integral time | Range:0.001~10.000s(Valid when F00.24=1 or 2) | 0.020s |
| F14.05 | Speed loop parameter switching frequency | Range:0.00Hz~20.00Hz(Valid when F00.24=1 or 2) | 5.00Hz |

Through F14.01 to F14.05, you can set the proportional gain and integral time of Speed loop regulator, so as to change the speed response characteristic under vector control mode.

The system dynamic response of speed loop can be faster if the proportional gain is increased or the integral time is decreased. However, if the proportional gain is too large or the integral time is too small, the system tends to oscillate.

The suggested adjusting way as below:

When the default parameter is not suitable, please fine adjust the parameters based on the default value. Proportional gain is usually adjusted first. Under the condition that the system is immune from oscillation, proportional gain can be increased as big as possible. Then adjust integral time so that the system responds fast and will not be over adjusted.

The above parameters are valid for Closed-loop or Open-loop speed control mode, invalid for V/F control and torque control mode.

| | | | |
|---------------|---|--|-----------|
| F14.06 | Stable coefficient of low frequency generating | Range: 0~50(Valid when F00.24=1 or 2) | 25 |
|---------------|---|--|-----------|

When the motor connected to frequency inverter under a low frequency generating status, Please adjusting this parameter appropriately.

For example, the frequency inverter will be unstable when drives a potential load which is declining gradually. Increasing F14.06 will improve the stability of the system.

| | | | |
|---------------|---------------------------------------|---|--------------|
| F14.07 | Current loop proportional gain | Range: 1~500(Valid when F00.24=1 or 2) | 70 |
| F14.08 | Current loop integral time | Range: 0.1~100.0ms(Valid when F00.24=1 or 2) | 4.0ms |

F14.07 and F14.08 are the PI regulator parameters of Current loop.

The system torque dynamic response can be faster if the Current loop proportional gain P is increased or Current loop integral time constant Ti is decreased.

The system stability can be improved if the Current loop proportional gain P is decreased or integral time constant Ti is increased.

In general, the above parameters don't need change.

| | | | |
|---------------|--|--|---------------|
| F14.09 | Motor-driven torque current limit value | Range: 0~250.0%(Valid when F00.24=1 ,2 and 3) | 160.0% |
| F14.10 | Braking torque current limit value | Range: 0~250.0%(Valid when F00.24=1 or 2) | 160.0% |

It is the range of output torque of speed loop defined by the positive torque and negative torque limit. When the application needs quick acceleration and deceleration, this parameter can be appropriately increased to meet the specific requirements. However, if it's too large, the drive tends to over-current.

In torque control mode, the range of actual torque output is restricted to the above limit too.

| | | | |
|---------------|--|---|--------------|
| F14.11 | Asynchronous motor flux-weakening control coefficient | Range: 20.0~100.0%(Valid when F00.24=1 or 2) | 80.0% |
| F14.12 | Asynchronous motor Min. flux coefficient | Range: 10.0~80.0%(Valid when F00.24=1 or 2) | 10.0% |

Parameters of F14.11, F14.12 Used to correcting the weakening curve in weakening field. The correction of the curve will improve the precision of speed control during weakening field. The minimum field reference is the minimum value of weakening field. And F14.12 is just available for Closed-loop vector control mode.

| | | | |
|---------------|---|---|------------|
| F14.13 | Torque reference and limit channel selection | Range: Unit digit: 0~8 Tens digit :0~8 Hundreds digit: 0~8 | 000 |
|---------------|---|---|------------|

Units digit: Torque provision channel selection

0: Digital setting

1:All analog provision(0-10V or 4-20mA corresponds to 0~200.0% Rated torque current of the motor)

2:AI2 analog provision**3: Terminal UP/DOWN adjusting**

4:Communication provision(Communication address: 1D01) . (0~10000
corresponds to 0~200.0% Rated torque current of the motor)

5:EAI1 analog provision (Extensible)**6:EAI2 analog provision (Extensible)****7: High speed Pulse provision (Please choose the related function of X8)****8: Terminal width provision (Please choose the related function of X8)**

The range of the above channels which from the Min value to the Max value corresponds to 0.0~200% Rated torque current of motor.

Tens digit: Electric torque limit channel selection

0: Digital setting (determined by F14.09)**1: AI1 analog setting****2: AI2 analog setting****3: Terminal UP / DOWN adjustment setting****4: Reserved****5: EAI1 analog Setting (Extended Valid)****6: EAI2 analog setting (Extended Valid)****7: High-speed pulse setting**

(X8 terminals need to select the appropriate function)

8: Terminal pulse width setting

(X8 terminals need to select the appropriate function)

Note: The maximum value of 1~ 8 channels corresponds to F14.09

Hundreds digit: Braking torque limit channel selection

0: Digital setting (Determined by F14.10)**1: AI1 analog setting****2: AI2 analog setting****3: Terminal UP / DOWN adjustment setting****4: Reserved****5: EAI1 analog Setting (Extended Valid)****6: EAI2 analog setting (Extended Valid)****7: High-speed pulse setting**

(X8 terminals need to select the appropriate function)

8: Terminal pulse width setting

(X8 terminals need to select the appropriate function)

Note: The maximum value of 1 ~ 8 channels corresponds to F14.10

When the torque limit value is modified by communication, the torque channel must be set to digital setting (Tens or hundreds digit are 0). Torque limitation can

be performed by directly modifying F14.09 or F14.10 by communication. The shutdown and power-down storage function are affected by F01.03 and F01.05 when terminal UP / DOWN is adjusted. If stop is not restored and power-down is saved, F01.03 = 3 and F01.05 = 00 need to be set.

| | | | |
|---------------|--------------------------------|-------------------------|-----------|
| F14.14 | Torque polarity setting | Range: 0000~2112 | 00 |
|---------------|--------------------------------|-------------------------|-----------|

Unit digit: Polarity of Torque reference

0: Positive

1: Negative

2: Defined by running command. While F14.13=2, and the ten's place of F00.20 equals 0, the torque direction is determined by the polarity of AI2.

Tens digit: Polarity of Torque compensation

0: Same direction with torque reference

1: Opposite direction with torque reference

Hundreds digit: F14.21 compensation weakened when the motor locked rotor

0: Invalid

1: Enable. This function prevents belt slippage caused by low frequency compensation F14.21 set too large or torque set too large and motor locked rotor.

Thousands digit: Torque control anti-reverse function

0: Invalid

1: Anti-reverse function is active continuously

2: Anti-reversal function enabled at startup. Only the start-up moment has anti-reverse function.

The units digit and the tens digit of F14.14 determine the polarity of the given and compensated torque. When AI2, EAI1, and EAI2 are selected, AI2, EAI1, and EAI2 are set to bipolar control. The given polarity of the torque is determined by the corresponding analog polarity, but not by unit digit of F14.14. The torque given direction can be dynamically switched by multi-function keys at the same time. It's available changing the direction of torque provision through multi-function key.

| | | | |
|---------------|-------------------------------------|---|-------------|
| F14.15 | Torque digital setting value | Range:0.0~200.0%(Valid when F00.24=1 or 2) | 0.0% |
|---------------|-------------------------------------|---|-------------|

When F14.13=0, the value of torque provision is set by F14.15. A 100.0% value of F14.15 corresponds to the rated current of motor. The actual output torque will be decreased when the motor under a weaken field status. When choosing digital setting, press up and down keypad can revise the torque value.

| | | | |
|---------------|---|-------------------|----------|
| F14.16 | Forward speed limit channel selection in torque control mode | Range: 0~8 | 0 |
|---------------|---|-------------------|----------|

0: Digital setting**1:AI1 analog provision****2:AI2 analog provision****3: Terminal UP/DOWN adjusting****4: Communication provision(Communication address: 1D0A).****5:EA11 analog provision (Extensible)****6:EA12 analog provision (Extensible)****7: High speed Pulse provision (Please choose the related function of X8)****8: Terminal width provision (Please choose the related function of X8)**

When positive torque provided, if the load torque is smaller than the output torque, the motor's rotational speed will rise forward continuously to the forward frequency limit defined by limit channel (F14.16),so as to avoiding runaway of the motor.

| | | | |
|---------------|---|-------------------|----------|
| F14.17 | Reverse frequency limit channel selection in torque control mode | Range: 0~8 | 0 |
|---------------|---|-------------------|----------|

0: Digital setting**1:AI1 analog provision****2:AI2 analog provision****3: Terminal UP/DOWN adjusting****4: Communication provision(Communication address: 1D0B).****5:EA11 analog provision (Extensible)****6:EA12 analog provision (Extensible)****7: High speed Pulse provision (Please choose the related function of X8)****8: Terminal width provision (Please choose the related function of X8)**

When negative torque provided, if the load torque is smaller than the output torque, the motor's rotational speed will rise reverse continuously to the reverse frequency limit defined by limit channel (F14.17),so as to avoiding runaway of the motor.

| | | | |
|---------------|---|--|----------------|
| F14.18 | Forward Speed limit in Torque control mode | Range: 0.00Hz~Upper limit freq.(Valid when F00.24=1 or 2) | 50.00Hz |
| F14.19 | Reverse Speed limit in Torque control mode | Range: 0.00Hz~Upper limit freq.(Valid when F00.24=1 or 2) | 50.00Hz |

When F14.16=0, F14.17=0, the related limit frequency of the positive torque or negative torque are confirmed by F14.18 and F14.19.

| | | | |
|---------------|---|---|---------------|
| F14.20 | Acc and Dec time of torque provision | Range: 0.000~60.000s Valid when F00.24=1 or 2) | 0.100s |
|---------------|---|---|---------------|

The torque provision from the provision channel will form the final torque provision after the Acc and Dec time of F14.20. Suitable value of F14.20 can avoid vibration of the motor which caused by saltation of torque provision.

| | | | |
|---------------|----------------------------|--|-------------|
| F14.21 | Torque compensation | Range: 0.0~100.0% Valid when F00.24=1 or 2) | 0.0% |
|---------------|----------------------------|--|-------------|

Tens digit of F14.14 and F14.21 determine the torque compensation polarity and offset. Normally, it is not necessary to set the torque compensation when the torque loss due to the mechanical loss of the motor is large. When the set value is 100%, it corresponds to the rated torque current of the motor. When the reference torque is less than 1.1% of rated torque, the torque compensation value defined in F14.21 is invalid.

| | | | |
|---------------|--|---|---------------|
| F14.22 | Positive torque gain regulation coefficient | Range: 50.0~150.0% Valid when F00.24=1 or 2) | 100.0% |
| F14.23 | Negative torque gain regulation coefficient | Range: 50.0~150.0% Valid when F00.24=1 or 2) | 100.0% |

When choosing positive torque provision, adjusting F14.22 will correct the matching of the actual output torque and the torque provision if they are unmatched.

When choosing negative torque provision, adjusting F14.23 will correct the matching of the actual output torque and the torque provision if they are unmatched.

| | | | |
|---------------|---------------------------------|---|-------------|
| F14.24 | Flux braking coefficient | Range: 0.0~300.0% (Valid when F00.24=1 or 2) | 0.0% |
|---------------|---------------------------------|---|-------------|

Under open-loop and closed-loop speed control mode, increasing the strength of the field can realize fast decreasing of the motor when stop. The energy generated during the field braking process will be consumed in a form of heat inside of the motor. As a result, the temperature of motor inside will increase when field braking frequently. Please care about the temperature of the motor not over the allowed maximum value. If an operation command be given during the process of field braking, the field braking function will be canceled and the frequency inverter will operate to the set frequency again. Please disable the field braking function when using braking resistor.

| | | | |
|---------------|--|--|------------|
| F14.25 | Pre-excitation start-up time constant | Range: 0.1~3.0(Valid when F00.24=1) | 0.5 |
|---------------|--|--|------------|

In SVC control mode, decrease the value of F14.25 appropriately will decrease the start time of the motor, realizing fast start performance.

| | | | |
|---------------|--|--|--------------|
| F14.26 | Speed loop proportional gain | Range: 0.010~6.000(Valid when F00.24=3) | 0.500 |
| F14.27 | Speed loop integral time constant | Range: 0.010~9.999(Valid when F00.24=3) | 0.360 |

Adjusting F14.26 and F14.27 will change the responsive characteristic of Vector control.

| | | | |
|---------------|--|---|------------|
| F14.28 | Motor stabilization coefficient | Range: 10~300(Valid when F00.24=3) | 100 |
|---------------|--|---|------------|

When the motor which connected to the drive is vibration and not stable, increasing F14.28 will get rid of the vibration.

| | | | |
|---------------|--|---|---------------|
| F14.29 | Compensation gain of vibration restrain | Range: 100.0~130.0%(Valid when F00.24=3) | 100.0% |
|---------------|--|---|---------------|

The compensation is 0 when F14.29=100%.Large enough of this value will lead to over-current when start operation.

| | | | |
|---------------|--|--|----------------|
| F14.30 | Torque compensation limit frequency | Range: 0.00Hz~Upper limit Freq(Valid when F00.24=1,2) | 20.00Hz |
|---------------|--|--|----------------|

When the output frequency is bigger than the value of F14.30, the torque compensation defined by F14.21 is 0.And the actual torque compensation will linear decrease from 0Hz to the frequency of F14.30.

7.16 Motor parameters Group: F15

| | | | |
|---------------|--|-----------------------------|-----------------------|
| F15.00 | Reserved | | |
| F15.01 | Asynchronous motor rated power | Range: 0.1~6553.5KW | Depend on type |
| F15.02 | Asynchronous motor rated voltage | Range: 1~690V | Depend on type |
| F15.03 | Asynchronous motor rated current | Range: 0.1~6553.5A | Depend on type |
| F15.04 | Asynchronous motor rated frequency | Range: 0.00~600.00Hz | Depend on type |
| F15.05 | Asynchronous motor rated rotational speed | Range: 0~60000r/min | Depend on type |
| F15.06 | Asynchronous motor Poles No. | Range: 1~7 | 2 |

Set the parameters according to the motor nameplate no matter whether V/F control mode or vector control mode is adopted, otherwise it may be abnormal.

To achieve better V/F or vector control performance, motor auto-tuning is required.

The motor auto-tuning accuracy depends on the correct setting of motor nameplate parameters.

| | | | |
|---------------|---|--|-----------------------|
| F15.07 | Asynchronous motor Stator resistance | Range: 0.001~65.535Ω(AC drive power<7.5KW) | Depend on type |
| | | Range: 0.0001~6.5535Ω(Ac drive power≥7.5KW) | |

| | | | |
|--------|---------------------------------------|--|----------------|
| F15.08 | Asynchronous motor Rotor resistance | Range: 0.001~65.535Ω(AC drive power<7.5KW) | Depend on type |
| | | Range: 0.0001~6.5535Ω(Ac drive power≥7.5KW) | |
| F15.09 | Asynchronous motor leakage inductance | Range: 0.01~655.35mH(AC drive power<7.5KW) | Depend on type |
| | | Range: 0.001~65.535mH (AC drive power≥7.5KW) | |
| F15.10 | Asynchronous motor mutual inductance | Range: 0.1~6553.5mH (AC drive power<7.5KW) | Depend on type |
| | | Range: 0.01~655.35mH (AC drive power≥7.5KW) | |
| F15.11 | Asynchronous motor no-load current | Range: 0.01~655.35A | Depend on type |



F15.07~F15.11 is the characteristic parameters of asynchronous motor, not display on the nameplate, which need detected by auto-tuning. To achieved a good control performance, please let the motor unload before start rotating auto-tuning. For the asynchronous motor that cannot be disconnected from the load, you can choose static auto-tuning or input the motor parameters manually. Another way is just set F15.01 and used the default parameters in F15.01~F15.11.Meantime,Choosing different type of G and P will also change the default parameters in F15.01~F15.11.

| | | | |
|-----------------------|----------|--|--|
| F15.12 ~ F15.18 | Reserved | | |
|-----------------------|----------|--|--|

| | | | |
|--------|---------------------------------------|------------|---|
| F15.19 | Motor parameter auto-tuning selection | Range: 0~3 | 0 |
|--------|---------------------------------------|------------|---|

0: No action

1: Static auto-tuning

It is applied to applications where the motor cannot be disconnected from the load or the process is complicated. Values on the motor's nameplate should be input correctly before starting auto-tuning(F15.01-F15.06),Set F15.11 as 1 and press ,back to monitoring mode, then press  to start auto-tuning which with a "tune" symbol on the keyboard.



After auto-tuning, the Drive will exit process automatically and the detected values of the stator's resistance, rotor's resistance and the leakage inductance will be saved in F15.07-F15.09.

In static auto-tuning mode, the value of No-load current and mutual inductive reactance will not be detected. The user can input the related values with the reference of the Motor factory data or the data on the motor test report. Without related value, please adopt the Default value. Otherwise it may cause negative influence on the performance of motor.

During the process of auto-tuning, any abnormal please press  to stop auto-tuning.

2: Rotating auto-tuning of Asynchronous motor

Rotating auto-tuning function is suitable for the applications which the load of motor is lighter than 30% of the rated load or some kind of small inertia load. Please try your best to disconnect the load of your motor and make the motor in static or unload state so that auto-tuning the value of motor exactly.

Values on the motor's nameplate should be input correctly before starting auto-tuning(F15.01-F15.06),Set F15.19 as 2 and press , back to monitoring mode, then press  to start auto-tuning which with a "tune" symbol on the keyboard. When rotation setting after the motor line is connected, the motor runs in the wrong direction (Negative for the device or the load is larger in the current direction). You can set F01.16 hundreds digit to 1 running reverse direction rotation tuning. The F01.16 settings need to be manually restored after setting.

After auto-tuning, the Drive will exit process automatically and the detected values of the stator's resistance, rotor's resistance, the leakage inductance, No-load current and mutual inductive reactance will be saved in F15.07-F15.11.

During the process of auto-tuning, any abnormal please press  to stop auto-tuning.

3: Reserved

| | | | |
|-----------------------|----------|--|--|
| F15.20 ~ F15.22 | Reserved | | |
|-----------------------|----------|--|--|

7.17 Closed-loop encoder parameters Group: F16

| | | | |
|--------|--------------------------|-----------|---|
| F16.00 | Zero-speed servo enabled | Range:0,1 | 0 |
|--------|--------------------------|-----------|---|

Zero-speed servo enabled

0: Zero-speed servo is invalid

1: Zero-speed servo is valid

While F16.00=1 or the terminal function 67 is valid, under the circumstance that there is no run command and the motor speed is less than the lower limit F01.12, the inverter is on the zero-speed control .

| | | | |
|---------------|----------------------------|-----------------------|-------------|
| F16.01 | Encoder line number | Range: 0~10000 | 1024 |
|---------------|----------------------------|-----------------------|-------------|

This parameter should be set as same as the value of encoder installed on the axis of motor, or it will lead to an offset between the monitor speed and the actual speed of the motor.

| | | | |
|---------------|-----------------------------|--|-----------|
| F16.02 | Direction of encoder | Range: units digit:0,1 tens digit:0~3 | 00 |
|---------------|-----------------------------|--|-----------|

Units digit: Phase sequence of AB phase

0: Forward

1: Reverse

Tens digit: Set of point positioning and seeking position direction

0: Seeking position according to command direction.

1: Seeking position according to forward direction.

2: Seeking position according to reverse direction.

3: Seeking position according to random direction.

The above parameters define the Encoder pulses per revolution and AB phase sequence of encoder, wrong phase sequence will lead to over-current alarm of the drive.

| | | | |
|---------------|---|----------------------------|--------------|
| F16.03 | Encoder fractional frequency coefficient | Range: 0.001~60.000 | 1.000 |
|---------------|---|----------------------------|--------------|

This parameter can correct the actual speed of the motor when the encoder not installed on the axis of motor.

For example, when the encoder installed on a reduction gears with a 10:1 ratio, you should set F16.02 as 10.000 so that get a correct feedback of actual motor speed.

Because of encoder usually install on the axis of motor in closed-loop vector control mode, so there is no need setting this parameters in this mode.

| | | | |
|---------------|--------------------------------------|---------------------|-----------|
| F16.04 | Encoder filtering coefficient | Range: 5~100 | 15 |
|---------------|--------------------------------------|---------------------|-----------|

In some occasion with strong interference, increasing the value of F16.04 properly will weaken the vibration of the motor which because of the interference of the encoder signal. Meantime, a too big and too small value of F16.04 will lead to the vibration of the system.



Note

Except for correct setting of F16 parameters Group, Correct setting of F00.19 is also needed for a normal Closed-loop vector control.

| | | | |
|---------------|------------------------------|-------------------|----------|
| F16.05 | Position control mode | Range: 0~4 | 0 |
|---------------|------------------------------|-------------------|----------|

0:Position control is invalid.

1:Point positioning mode.

2:Recovery point positioning mode

3~4:Reserved

While F16.05=1, No.66 multi-function input terminal is valid, inverter is positioned on the angle defined by F16.12 according to the position seeking mode defined by the ten's place of F16.02. Under the mode of point positioning, if losing the Z pulse, the inverter will alarm fault of E-40 (Z pulse losing)

While F16.05=2, No.69 multi-function input terminal is valid, under the non-jog running command, the motor will run to the original location recorded by system, the original location can be determined by the terminal function 68 or the first power on.

| | | | |
|---------------|---|-----------------------------|----------------|
| F16.06 | Position control maximum frequency | Range: 0.01~100.00Hz | 30.00Hz |
| F16.07 | Position control minimum frequency | Range: 0.01~5.00Hz | 0.01Hz |

Parameter of F16.06, F16.07 are not limited by F01.11, F01.12, F01.13.

| | | | |
|---------------|--|----------------------|-----------|
| F16.08 | Creeping afterpulse count before finishing the position | Range:0~60000 | 30 |
|---------------|--|----------------------|-----------|

Under the set of positioning control for the parameter, it is the pulse count that the motor creeps at frequency of F16.07.

The parameter setting should be reasonable, if the setting value is too low, the final positioning may overshoot, sequentially affect the ultimate positioning precision; if the setting value is too high, the final positioning may switch from the higher output frequency to the creeping frequency, sequentially cause the vibration for motor and machine system. When the inertia is high but friction is low, the setting value should be increased.

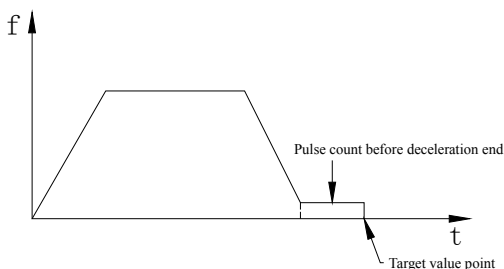

Fig. 7-44 Afterpulse when deceleration is over at positioning

| | | | |
|---------------|---|--------------------|----------|
| F16.09 | Positioning reaches to the pulse range | Range:1~255 | 2 |
|---------------|---|--------------------|----------|

The parameter is set as the positioning control, the positioning reaches within the permissible error range of position to target setting value. If set F16.09=2, within the ± 2 pulses range of target position, it defaults the position has reached, see the Fig. 7-45 Then terminal Y can output position reaching signal.

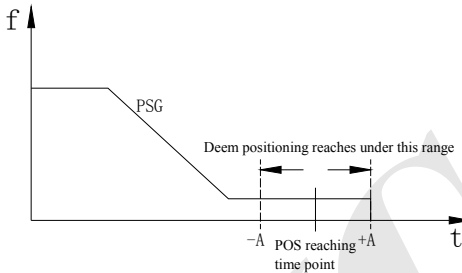

Fig. 7-45 Positioning reaches to the setting range

| | | | |
|---------------|------------------------------|---------------------|------------|
| F16.10 | Position control gain | Range:1~5000 | 200 |
|---------------|------------------------------|---------------------|------------|

The bigger this parameter, the faster the location responds, but too higher setting value may cause the system oscillation.

| | | | |
|---------------|-----------------------------|---------------------------|---------------|
| F16.11 | PSG alteration point | Range:0.01~30.00Hz | 5.00Hz |
|---------------|-----------------------------|---------------------------|---------------|

The smaller this parameter, the faster the location responds, but too lower setting value may cause the system oscillation.

| | | | |
|---------------|---|---------------------------------|-------------|
| F16.12 | Point positioning relative to Z-axis angle | Range:0.00~360.00 degree | 0.00 |
|---------------|---|---------------------------------|-------------|

| | | | |
|---------------|---|----------------------|------------|
| F16.13 | Positioning control acceleration-deceleration time | Range:1~60000 | 200 |
|---------------|---|----------------------|------------|

The bigger this parameter, the faster the location responds, but too higher setting value may cause the system oscillation. The unit of time is determined by the F01.19, the factory default of F16.13 is 20.0s.

7.18 Reserved parameters Group1:F17

| | | | |
|-------------------------------------|-----------------|--|--|
| F17.00 ~ F17.20 | Reserved | | |
|-------------------------------------|-----------------|--|--|

7.19 Enhanced Control Functions Parameters Group: F18

| | | | |
|---------------|--|--------------------|----------|
| F18.00 | Operation panel control frequency binding | Range: 0~15 | 0 |
|---------------|--|--------------------|----------|

F18.00 can bundle operation panel with frequency reference channels, to achieve synchronous switching.

0: No bundling

1: Keyboard digital provision

2:AI1 analog provision

3:AI2 analog provision

4: Terminal UP/DOWN adjust setting

5: Communication provision (MODBUS and FieldBus used a same storage registers)

6:EAI1 analog provision (Extensible)

7:EAI2 analog provision (Extensible)

8: High speed Pulse provision (Please choose the corresponding functions of X8)

9: Terminal pulse-width provision (Please choose the corresponding functions of X8)

10: Terminal encoder provision (Defined by X1 and X2)

11~15:Reserved

Different control command channels can be bundled to the same frequency reference channel. After success bundled, the bundled frequency reference channel have a highest priority and just available for Main frequency bundling.

| | | | |
|---------------|---|--------------------|----------|
| F18.01 | Terminal control frequency binding | Range: 0~15 | 0 |
|---------------|---|--------------------|----------|

Please refer to the description of F18.00

| | | | |
|---------------|--|--------------------|----------|
| F18.02 | Communication control frequency binding | Range: 0~15 | 0 |
|---------------|--|--------------------|----------|

Please refer to the description of F18.00

| | | | |
|---------------|--|---|-------------|
| F18.03 | Digital frequency integral function selection | Range: units digit: 0,1 tens digit: 0,1 hundreds digit: 0、1 thousands digit: 0、1 | 0000 |
|---------------|--|---|-------------|

Units digit: Keyboard UP/DOWN Integration control

0: Integral function enabled

1: Integral function disabled

Tens digit: Terminal UP/DOWN Integration control

0: Integral function enabled

1: Integral function disabled

Hundreds digit: Keyboard shuttle knob enable (shuttle keyboard effective)

0: The shuttle knob is valid in the monitoring interface

1: The shuttle knob is invalid in the monitoring interface

This function should cooperate with 16 and 17 functions of multi-function terminal.

Thousands digit: keypad adjustment of frequency classic mode selection

0: invalid

1: valid, adjustment range decided by F18.05

| | | | |
|---------------|---------------------------------------|----------------------------|---------------|
| F18.04 | Keyboard UP/DOWN integral rate | Range: 0.01~50.00Hz | 0.10Hz |
|---------------|---------------------------------------|----------------------------|---------------|

When the keyboard UP/DOWN Integration is enabled, if keep adjusting the frequency in the same direction, the Integration effect will be effective, and the Integration rate is determined by F18.04.

This function is suitable for the applications that need adjusting frequency quickly.

| | | | |
|---------------|--|----------------------------|---------------|
| F18.05 | Keyboard no integral single step's size setup | Range: 0.01~10.00Hz | 0.01Hz |
|---------------|--|----------------------------|---------------|

When the keyboard UP/DOWN integral function disabled, the rate of adjusting frequency fixed by the value of F18.05.

| | | | |
|---------------|---------------------------------------|----------------------------|---------------|
| F18.06 | Terminal UP/DOWN Integral rate | Range: 0.01~50.00Hz | 0.20Hz |
|---------------|---------------------------------------|----------------------------|---------------|

| | | | |
|---------------|--|----------------------------|---------------|
| F18.07 | Terminal no integral single step's size setup | Range: 0.01~10.00Hz | 0.10Hz |
|---------------|--|----------------------------|---------------|

Please refer to the functions of F18.04 and F18.05 for the functions of F18.06 and F18.07.

| | | | |
|---------------|--|----------------------------|---------------|
| F18.08 | Droop control decline frequency | Range: 0.00~10.00Hz | 0.00Hz |
|---------------|--|----------------------------|---------------|

When several drivers drive one load, the function can make the drives share the load equally. When the load of one drive is heavier, the drive will reduce its output frequency to shed part of the load.

This function is suitable for the share of several motors which with a common load. The value of F18.08 is the maximum reduced frequency when the drive reaches the rated power.

| | | | |
|---------------|---------------------------------------|------------------------|----------|
| F18.09 | Setup accumulate power on time | Range: 0~65535h | 0 |
|---------------|---------------------------------------|------------------------|----------|

| | | | |
|---------------|----------------------------------|------------------------|----------|
| F18.10 | Setup accumulate run time | Range: 0~65535h | 0 |
|---------------|----------------------------------|------------------------|----------|

When the actual accumulate operation time reach to the set accumulated operation time (F18.10), the drive will output an indication signal. Please refer to the description of F09.00~F09.03.

F18.09 defined the expected accumulated time of power on from Ex factory.



Note

Power-on time and accumulated run time can be checked by monitoring parameters group C.

| | | | |
|---------------|-----------------------------------|-------------------|----------|
| F18.11 | Timing run function enable | Range: 0,1 | 0 |
|---------------|-----------------------------------|-------------------|----------|

0: Disabled

1: Enabled

| | | | |
|---------------|-----------------------------|-----------------------------|---------------|
| F18.12 | Timing run stop time | Range: 0.1~6500.0Min | 2.0Min |
|---------------|-----------------------------|-----------------------------|---------------|

When F18.11 Timing operation function enabled, the driver will start the timer with inverter start.

The drive will stop automatically and the multi-function Yi (Set Yi as the 33 function) will output an indicator signal when reach to the set stop time.



Note

The timer of inverter start form 0 every times, the user can monitor the current operation time through the F0 Group.

| | | | |
|---------------|-----------------------------------|-----------------------------|---------------|
| F18.13 | Currently run arrival time | Range: 0.0~6500.0Min | 1.0Min |
|---------------|-----------------------------------|-----------------------------|---------------|

When the actual operation time reach to this time, the multi-function Yi (choose Yi as 34 function) will output an indicator signal of “Currently operation time reached”.

| | | | |
|---------------|--|-------------------|----------|
| F18.14 | Keyboard UP/DOWN selection under monitor mode | Range: 0~6 | 0 |
|---------------|--|-------------------|----------|

0: Keyboard frequency provision frequency adjusting

1: PID digital reference value adjusting

2~6:Reserved

When F18.14 =1, UP/DOWN is used to adjust the PID digital reference value in Monitor Mode merely.

When F18.14 =0, UP/DOWN is used to adjust the frequency value not only in Monitor Mode when choose frequency digital reference channel.

| | | | |
|---------------|---|--|----------------|
| F18.15 | V/F vibration restrain end frequency | Range: 0.00Hz~upper limit frequency | 50.00Hz |
|---------------|---|--|----------------|

In V/F Control mode, when the output frequency of inverter is bigger than the limit frequency, the suppression of F03.12 will be disabled. Adjusting F18.15 can restrain the shake phenomenon of motor in a large range.

| | | | |
|---------------|-----------------------------------|--|-------------|
| F18.16 | Advanced control functions | Range: Unit digit: 0、1 Tens digit: 0、1 Hundreds digit: 0、1 Thousands digit: 0、1 (This parameter is valid when F00.24 = 1 or 2) | 0001 |
|---------------|-----------------------------------|--|-------------|

When F18.16 tens digit is 0, the torque limit is set according to the rated current of the inverter. When this bit is 1, it is limited according to the rated torque current of the motor. Take the electric torque as an example: F14.13 tens digit = 1

(All given), $F14.09 = 150.0\%$, inverter rated current $I_n = 100A$, motor rated current I_m ($F15.01$) = 90, motor no-load current I_o ($F15.11$) = 30A. When unit digit of $F18.16=0$, All maximum, the maximum output current of the inverter = $I_n * F14.09 = 150A$. When unit digit of $F18.16=1$, All maximum, the maximum output current of the inverter = $\sqrt{((F14.09 \times \sqrt{(I_m \times I_m - I_o) + I_o^2)} + I_o)^2} = 130A$.

When hundreds digit of $F18.16$ is 1, enable below the lower limit frequency fast traverse function. When a hoist load occurs when the hook phenomenon, you can open this function, and appropriately improve the $F01.12$ parameters, can effectively solve this problem.

When thousands digit of $F18.16$ is 1, the PWM will be blocked when the torque is less than 1.1% and the motor speed is less than 2Hz in no speed torque control mode, and the motor is in the free state. This function is valid when $F00.24 = 1$.

| | | | |
|---------------|--------------------------------------|--|-----------|
| F18.17 | Cooling fan control selection | Range: units digit: 0~2 tens digit: 0,1 | 00 |
|---------------|--------------------------------------|--|-----------|

Units digit: fan control mode

0: Smart fan

1: Inverter is running all the time after power on

2: No running for fan, but it starts automatically when the temperature is higher than 75 degree.

Tens digit: Speed regulation fan control mode.

0: Smart PWM Speed regulation

1: Running at highest speed.

Under the smart control, after stopping the inverter, if the detection temperature is lower than 35 degree, the fan stop running automatically in 20s.

| | | | |
|---------------|----------------------------------|------------------------|-------------|
| F18.18 | No speed vector slip gain | Range: 50%~200% | 100% |
|---------------|----------------------------------|------------------------|-------------|

For speed sensorless vector control ($F00.24 = 1$), this parameter is used to adjust the speed accuracy of the motor: when the speed of the motor is low, the parameter is increased and vice versa.

| | | | |
|---------------|---|----------------------------|---------------|
| F18.19 | Low-order of total power consumption | Range: 0~9999 | 0 |
| F18.20 | High-order of total power consumption | Range: 0~65535 | 0 |
| F18.21 | Correction factor of power consumption calculation | Range: 50.0%~200.0% | 100.0% |

$F18.19$ and $F18.20$ show the total amount of power consumed by the load and the inverter. Similarly, C-x can be set to 59 and 60 to monitor the amount of power consumption by the keyboard. Where $F18.20$ parameter minimum unit represents

10000KWH, for example $F18.19 = 1000$, $F18.20 = 4$, the total power consumption = $4 \times 10000 + 1000 = 41000$ KWH.

Users can also set $F18.19$ and $F18.20$ to 0 to restart the calculation of the power consumption; if the calculated power consumption are not correct, the $F18.21$ parameter can be adjusted, so that the calculated power consumption correspond to actual consumption.

| | | | |
|---------------|--|------------------|----------|
| F18.22 | V/F separate control voltage reference channel. | Range:0~8 | 1 |
|---------------|--|------------------|----------|

0: Digital setting (determined by 18.23)

1: AI1 analog setting

2: AI2 analog setting

3: Terminal UP / DOWN adjustment setting

4: Reserved

5: EAI1 analog Setting (Extended Valid)

6: EAI2 analog setting (Extended Valid)

7: High-speed pulse setting

(X8 terminals need to select the appropriate function)

8: Terminal pulse width setting

(X8 terminals need to select the appropriate function)

Note: The maximum value of 0 ~ 8 channels correspond to the motor rated voltage

When $F03.00 = 5$, and $F00.24 = 0$, then running VF separation control. The frequency is given by the original way, the voltage is determined by the $F18.22$, you can choose digital set, analog set, the terminal UP / DOWN set, etc., can also be directly modified by communication $F18.23$ to achieve communication set. General induction heating, inverter power, torque motor could be controlled by this way.

| | | | |
|---------------|---|---------------------------|-------------|
| F18.23 | V/F separate control voltage digital reference | Range: 0.0%~100.0% | 0.0% |
|---------------|---|---------------------------|-------------|

V/F separate control voltage digital reference. 100.0% corresponds to the rated voltage of the motor.

| | | | |
|---------------|--------------------------------|-----------------------|-----------|
| F18.24 | Low frequency slip gain | Range: 30~300% | 1% |
|---------------|--------------------------------|-----------------------|-----------|

This parameter when $F00.24=1$ valid, properly to adjust the parameter to improve the precision of low frequency rotation speed.

7.20 Protective Relevant Function Parameters Group:F19

| | | | |
|--------|--------------------------------|--|------|
| F19.00 | Power off restart waiting time | Range: 0.0~20.0s (0 indicates disabled this function) | 0.0s |
|--------|--------------------------------|--|------|

When the power is off, then power-on, whether this inverter will start automatically after a waiting time.

When F19.00=0.0s, after the power off then power-on, inverter will not start automatic. F19.00≠0.0s, after the power off then power-on again, if all is ready, inverter will run automatically with the start method defined by F02.00 after waiting the time defined by F19.00.



Note

Conditions for repower-on after power-off: it should be in the running status before power-off; there's no fault and running signal maintained when power-on again; there's no other factors which affect normal starting.

| | | | |
|--------|-----------------------------------|--|------|
| F19.01 | Fault self-recovery times | Range: 0~10 (0 indicates no self-recovery function) | 0 |
| F19.02 | Fault self-recovery interval time | Range: 0.5~20.0s | 5.0s |

When the inverter is running, because of fluctuation of load, faults may happen in some case and it will top to output. In order not to stop the operation of equipment, choosing the recovery functions No alarm, stop in stopping mode. Inverter will recovery to run with speed-checking restart style, within the setting time, if inverter cannot run, then fault protection will begin, stop running. No alarm, when the self recovery times of fault are set to 0, self recovery function stops.



1. When using fault self recovery function, and make sure the equipment is permitted and inverter do not enter fault.
2. Self recovery function is not effective on fault Protection caused by power-on terminal protection, clock fault, overload and over-heated, output short-circuit, short circuit to ground ,and lack-voltage during running.
3. When F19.00≠0,open stop and restart function. We can start this equipment without operators, so be careful to use this function.

| | | | |
|--------|--|------------|---|
| F19.03 | Motor overload protection action selection | Range: 0~2 | 2 |
|--------|--|------------|---|

When the AC motors is overloaded , this mode of Protection will happen.

0: Alarm, continue operation; It happens with only warning, no motor overload Protection characteristic (used cautiously, at this time, inverter has nothing to do with load motor for overload protection;

1: Alarm, Stop according to the stop mode;

2: Fault, Free stop. When it is overloaded , the output of inverter is block , this AC motor free stop .

| | | | |
|---------------|--|--|---------------|
| F19.04 | Motor overload protection coefficient | Range: 10.0~2000.0% (Motor rated current) | 100.0% |
|---------------|--|--|---------------|

To protect the loading motors with different types from overloading effectively, make sure that the parameter F15.03 (motor rated current) is set according to the motor nameplate.

The motor overloading time can be adjusted by adjusting F19.04, As shown in Fig.7-46, when the output current of motor equals 150% of motor's rated current, and continues for the time determined by $4\text{min} * F19.04$, then alarm for motor overloading protection. If $F19.04=120.0\%$, then the overloading time is $4\text{min} * 120.0\%=4.8\text{min}$. The minimum overloading time of motor is 5s.

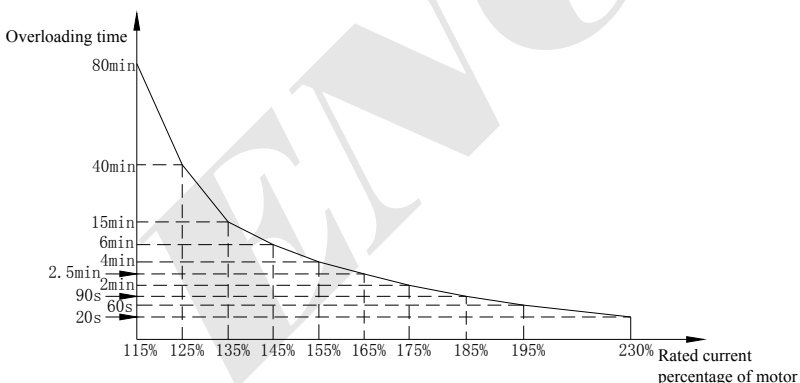

Fig.7-46 Electronic thermal relay protection

This adjustable value can base on the user's setting. In the same condition, if the AC motor is overloaded and need the fast protection, then decrease F19.04, or else increase.

| | | | |
|---------------|--|-------------------|----------|
| F19.05 | Inverter overload pre-alarm detection selection | Range: 0,1 | 0 |
|---------------|--|-------------------|----------|

0: Detection all the time. during the working process of inverter , it still work after detecting overload situation.

1: Enable only constant speed detection. Only the inverter work in a constant speed mode, it still works after detecting overload situation.

| | | | |
|---------------|--|--|-------------|
| F19.06 | Inverter overload pre-alarm detection level | Range: 20~180% (Inverter rated current) | 130% |
| F19.07 | Inverter overload pre-alarm delay time | Range: 0.0~20.0s | 5.0s |

If output current higher parameter F19.06, the set electrical level will go through delay time of F19.07, open collector will output enabled signal (please refer to fig7-47 and parameter list F09.00~F09.03).

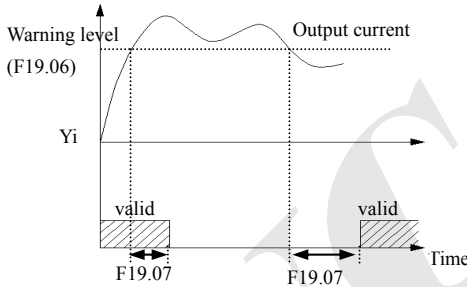

Fig.7-47 Overload alarm

| | | | |
|---------------|--|--|--------------|
| F19.08 | Motor underload alarm detection level | Range: 0.0~120.0% (Motor rated current) | 50.0% |
| F19.09 | Motor underload alarm detection time | Range: 0.1~60.0s | 2.0s |

The output current Inverter will lower than Underload alarm detection level F19.08 (definite the value, comparing to motor rating current), and the last time will over motor underload alarm detection level time F19.09, then Yi will output underload alarm Signal.

| | | | |
|---------------|---|--|-----------|
| F19.10 | Motor underload alarm detection action | Range: units digit: 0~2 tens digit: 0~2 | 00 |
|---------------|---|--|-----------|

Units digit: detection selection.

0: No detection.

1: The operation has been detected all the time. This detection is enabled during the running process of inverter.

2: Detect in constant speed mode only. This detection is enabled during the constant speed mode only.

Tens digit: action selection.

0: when it's in alarm, continue operation. inverter will only warn when detecting motor is underload alarm

1: Alarm, Stop according to the stop mode

2: Fault, Free stop. The inverter will detect motor is in underload alarm, and

it will lock PWM output, the motor will stop with free rotation.

| | | | |
|--------|--|---|-------------|
| F19.11 | Input & output phase loss, short circuit detection action | Range: units digit: 0,1 tens digit: 0,1 hundreds digit: 0,1 thousands digit: 0,1 | 1111 |
|--------|--|---|-------------|

Units digit: input phase failure protect

0: No detection.

1: Fault, Free stop .When inverter detect that the input is lacked one phase, alarm in input lacked, alarm, and free stop.

Tens digit: output phase failure protection

0 : No detection.

1:Fault, Free stop .When inverter detect that the output is lacked one phase, alarm in input lacked, then Free stop.

Hundreds digit: power-on will detect Short circuit protection.

0: No detection.

1: Fault, Free stop. When inverter is power-on, the output to earth is short-circuiting. At this time, the fault of short-circuiting to earth while power on is alarmed, the inverter freely stops.

Thousands digit: The detection to earth Short circuit protection in the running mode.

0: No detection.

1: Fault, Free stop. When inverter is power-on, the output to earth is short-circuiting during the running process. At this time, the fault of short-circuiting to earth while running is alarmed, the inverter freely stops.

| | | | |
|--------|------------------------------------|-------------------|----------|
| F19.12 | Overvoltage stall selection | Range: 0,1 | 1 |
|--------|------------------------------------|-------------------|----------|

0: Disabled.

1: Enabled

| | | | |
|--------|---|------------------------|-------------|
| F19.13 | Overvoltage stall protection voltage | Range: 100~150% | 125% |
|--------|---|------------------------|-------------|

During deceleration, the motor's decelerate rate may be lower than that of drive's output frequency due to the load inertia. At this time, the motor will feed the energy back to the drive, resulting in the voltage rise on the drive's DC bus. If no measures taken, the drive will trip due to over voltage.

During the deceleration, the drive detects the bus voltage and compares it with the over voltage point at stall defined by F19.13. If the bus voltage exceeds the stall over-voltage point, the output frequency of the inverter will stop decreasing. When the bus voltage become lower than the point, then run slowly, as shown in Fig. 7-48.

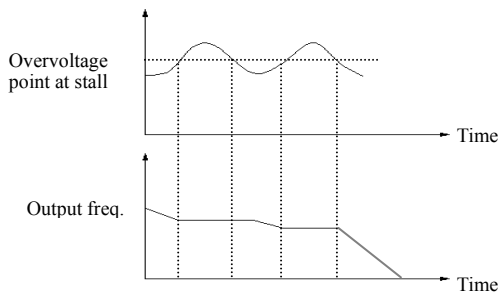

Fig. 7-48 Over-voltage at stall

| | | | |
|--------|---|-----------------------|-----------|
| F19.14 | Automatic current limit level | Range: 50~230% | 170% |
| F19.15 | Frequency decline rate of automatic current limit | Range: 0.00~99.99Hz/s | 10.00Hz/s |
| F19.16 | Automatic current limit action selection | Range: 0,1 | 0 |

0: Constant speed disabled.

1: Constant speed enabled.

Auto current limiting function is used to limit the load current smaller than the value defined by F19.14 in real time. Therefore the drive will not trip due to surge over-current. This function is especially useful for the applications with big load inertia or big change of load.

F19.14 defines the threshold of auto current limiting. It is a percentage of the drive's rated current.

F19.15 defines the decrease rate of output frequency when the drive is in auto current limiting status.

If F19.15 is set too small, overload fault may occur. If it is set too big, the frequency will change too sharply and therefore, the drive may be in generating status for longtime, which may result in overvoltage protection.

Auto current limiting function is always active in Acc or Dec process. Whether the function is active in constant speed operating process is decided by F19.16.

F19.16=0 Auto current limiting function is disabled in constant speed operating process;

F19.16=1 Auto current limiting function is enabled in constant speed operating process;

In auto current limiting process, the drive's output frequency may change; therefore, it is recommended not to enable the function when the drive's output frequency is required stable.

| | | | |
|---------------|---|-------------------------|-------------|
| F19.17 | Rapid current-limiting coefficient | Range: 150%~250% | 230% |
|---------------|---|-------------------------|-------------|

The rapid current limit function can reduce the AC drive's over-current faults at maximum, guaranteeing uninterrupted running of the AC drive. If the AC drive is in a rapid current limit state for a long time, the AC drive may be overheated or overloaded for further protection.

The lower the setting of the F19.17, the more sensitive the rapid current limit is. When the F19.17 equals 250%, the rapid current limit function is invalid.

| | | | |
|---------------|---|-------------------|----------|
| F19.18 | Motor run section selection when instant power off | Range: 0,1 | 0 |
|---------------|---|-------------------|----------|

0: disabled

1: enabled

| | | | |
|---------------|---|------------------------------|------------------|
| F19.19 | Frequency droop rate when instant power off | Range: 0.00~99.99Hz/s | 10.00Hz/s |
| F19.20 | Voltage rebound estimate time when instant power off | Range: 0.00~10.00s | 0.10s |
| F19.21 | Action estimate voltage when instant power off | Range: 60~100% | 80% |
| F19.22 | Allowed the longest off time when instant power off | Range: 0.30~5.00s | 2.00s |

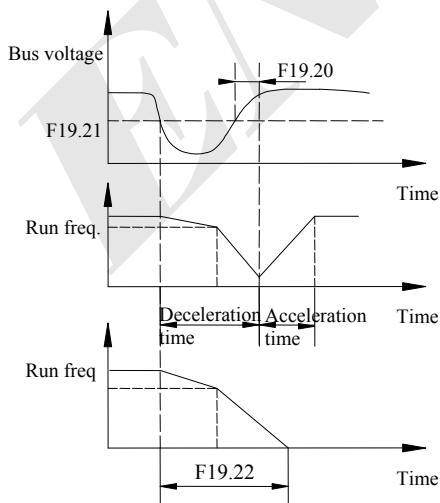

Fig 7-49 AC drive action diagram upon instantaneous power failure

Upon instantaneous power failure or sudden voltage dip, the DC bus voltage of the AC drive reduces. This function enables the AC drive to compensate the DC bus voltage reduction with the load feedback energy by reducing the output frequency so as to keep the AC drive running continuously.

If F19.18 = 1, upon instantaneous power failure or sudden voltage dip, the AC drive decelerates. Once the bus voltage resumes to normal, the AC drive accelerates to the set frequency. If the bus voltage remains normal for the time exceeding the value set in F19.20, it is considered that the bus voltage resumes to normal.

When instantaneous power failure happens, if the time is exceed the time of F19.22 definite, inverter No alarm, stop in stopping mode Free stop.

| | | | |
|---------------|--|-------------------|----------|
| F19.23 | Terminal external device fault action selection | Range: 0~2 | 2 |
|---------------|--|-------------------|----------|

0: Alarm, continue operation .When inverter checked that Terminal of the external is no alarm, stop in stopping mode enabled, it will alarm, then run continue. Under this mode, the inverter will do nothing with Terminal of the external in No alarm, stop in stopping mode, so please cautiously use.

1: Alarm, Stop according to the stop mode .When Inverter detect terminal outside fault is enabled, alarm, and then press Stop in stopping mode.

2: Fault, Free stop .When inverter detect terminal external fault is enabled, alarm for external equipment fault, and free stop.

| | | | |
|---------------|---|-------------------|----------|
| F19.24 | Power on terminal protection selection | Range: 0,1 | 0 |
|---------------|---|-------------------|----------|

0: Disabled.

1: Enabled.

When setting power down and then restart function is enabled, this function is disabled. When the running command channel is terminal command, and when power-on and detection run the command is enabled, it will get terminal protection with faults, this function only is enabled for terminal FWD/REV function.

| | | | |
|---------------|-------------------------------------|--------------------------|-------------|
| F19.25 | Provide lost detection value | Range: 0~100% | 0% |
| F19.26 | Provide lost detection time | Range: 0.0~500.0s | 0.5s |

When setting PID is lower than F19.25 definition continuous(setting the Max. as base), and the constant time is over than the time that F19.26 definition detected, then PID setting will lost, inverter will run base on F19.31 Units place set.PID loss detection show on fig 7-50.

| | | | |
|---------------|--------------------------------------|--------------------------|-------------|
| F19.27 | Feedback lost detection value | Range: 0~100% | 12% |
| F19.28 | Feedback lost detection time | Range: 0.0~500.0s | 0.5s |

When the feedback value of PID is lower than F19.27 definite(setting the input as base, and the constant time is over than the time that F19.28 definition detected, then PID setting will lost.

Inverter will run base on F19.31 Tens place set.PID loss detection show on fig 7-50.

| | | | |
|---------------|---|--------------------------|-------------|
| F19.29 | Deviation magnitude abnormal detection value | Range: 0~100% | 50% |
| F19.30 | Deviation magnitude abnormal detection time | Range: 0.0~500.0s | 0.5s |

When the Error amount of PID is higher than F19.29 definite(setting the input as base, and the constant time is over than the time that F19.30 definition detected, then PID setting will lost. inverter will run base on F19.31 hundred's place set.PID loss detection show on fig 7-50.

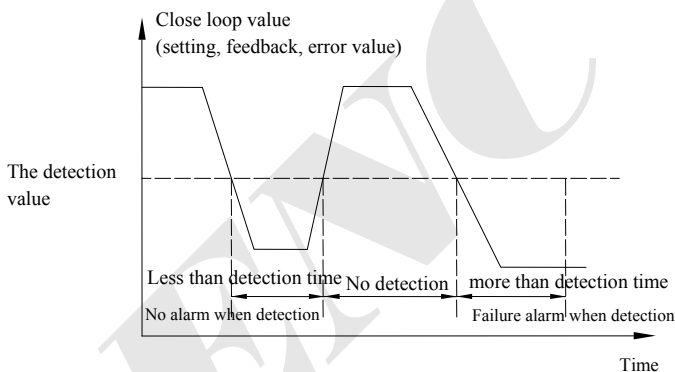

Fig. 7-50 Closed loop detection timing diagram

| | | | |
|---------------|--------------------------------------|--|------------|
| F19.31 | Protection selection 1 action | Range: units digit: 0~3 tens digit: 0~3 hundreds digit: 0~3 | 000 |
|---------------|--------------------------------------|--|------------|

This parameter definite the Internal PID controls the action selection of the setting loss and the fault Error amount. When it's set as 0 OR 1, inverter will have no response. And with no protection selection, users should set this parameter basing on the actual applications.

Units digit: setting PID lost motion detection.

0: no detection.

1: Alarm, continue operation

2: Alarm, Stop according to the stop mode

3: Fault, Free stop.

Tens digit: PID feedback for lost motion detection.

0: no detection.

1: Alarm, continue operation.

2: Alarm, Stop according to the stop mode.

3: Fault, Free stop.

Hundreds digit: The amount of error fault for PID detection operation

0: no detection.

1: Alarm, continue operation

2: Alarm, Stop according to the stop mode

3: Fault, Free stop.

| | | | |
|--------|-------------------------------|---|------|
| F19.32 | Protection action selection 2 | Range: units digit: 0~2 tens digit: 0~2 hundreds digit: 0~2 thousands digit: 0,1 | 1200 |
|--------|-------------------------------|---|------|

This parameter define the communication fault, E²PROM fault, Contactor fault and lack-voltage when it's in No alarm, stop in stopping mode for the action selection of inverter. When it's set as 0, during the fault situation, inverter will only alarm. And with no protection selection, users should set this parameter basing on the actual applications.

Units digit: communication fault action, including communication replay and fault.

0: Alarm, continue operation

1: Alarm, Stop according to the stop mode

2: Fault, free stop .

Tens digit: E²PROM fault action selection.

0: Alarm, continue operation

1: Alarm, stop according to the stop mode

2: Fault, free stop.

Hundreds digit: Contactor fault action selection.

0: Alarm, continue operation

1: Alarm, stop according to the stop mode

2: Fault, free stop.

Thousands digit: running lack-Voltage fault display action selection.

0: no detection.

1: Fault, free stop.

| | | | |
|--------|----------|--|--|
| F19.33 | Reserved | | |
| F19.34 | Reserved | | |

| | | | |
|---------------|---|--|-----------|
| F19.35 | Fault indication and clock during the period of recovery | Range: units digit: 0,1 tens digit: 0,1 | 00 |
|---------------|---|--|-----------|

Units digit: During automatic reset of fault display selection.

0: Action. During automatic reset, Yi and Relay of will update display the Signal based on the internal state.

1: No action. During automatic reset, Yi and Relay display Signal No action.

Tens digit: Lock function selection, to realize display before power-off.

0: disabled.

1: enabled. When this function is enabled, if the inverter shows the fault before the last time power down, then the inverter will display the fault last time fault state, make sure that users will know about the inverter's potential faults.

| | | | |
|---------------|--|-------------------|----------|
| F19.36 | Continuous run frequency selection when alarm | Range: 0~3 | 0 |
|---------------|--|-------------------|----------|

This parameter defines the run frequency when users choose “Alarm, continues to run” for the inverter's failure.

0: running at the current setting frequency.

1: running at the upper limiting frequency.

2: running at the lower limit frequency.

3: running at the fault Alternate frequency.

| | | | |
|---------------|-----------------------------------|--|----------------|
| F19.37 | Abnormal standby frequency | Range: 0.00Hz~upper limit frequency | 10.00Hz |
|---------------|-----------------------------------|--|----------------|

This parameter definite the alternative running frequency when inverter fault , user can use it along with parameterF19.36.

| | | | |
|---------------|--|--|-------------|
| F19.38 | Disconnection testing time of encoder | Range: 0.0~8.0s (No detection while at 0) | 0.0s |
|---------------|--|--|-------------|

When the inverter runs with the closed-loop vector mode, the detection starts while the run frequency is higher than 1Hz, when the A,B-phase signal of the encoder continues for the time set in F19.38, and no feedback has been received, then the inverter alarms the fault of E-37 and freely stop.

| | | | |
|---------------|----------------------------------|---|---------------|
| F19.39 | Overspeed detection value | Range: 0.0~120.0% (equals upper limit frequency) | 120.0% |
| F19.40 | Overspeed detection time | Range: 0.00~20.00s (no detection while at 0) | 0.00s |

Under the open-loop or the closed-loop vector mode, when it was detected that the motor rotational speed is higher than the setting value of F19.39, and after the continue time of F19.40's setting value, the inverter alarms fault of E-38 and freely stop. No detection when F19.40 equals 0, but detection is still available when F19.39 equals 0.

| | | | |
|---------------|---|--|--------------|
| F19.41 | Detection value of too large speed deviation | Range: 0.0~50.0% (equals upper limit frequency) | 10.0% |
| F19.42 | Detection time of too large speed deviation | Range: 0.00~20.00s (no detection while at 0) | 0.00s |

Under the open-loop or the closed-loop vector running mode, when it was detected that the difference of motor rotational speed and setting rotational speed equals the setting value of F19.41, and after the continue time of F19.42's setting value, the inverter alarms fault of E-39 and freely stop. No detection when F19.42 equals 0, but detection is still available when F19.41 equals 0.

| | | | |
|---------------|--|--------------------------|--------------|
| F19.43 | Overvoltage suppression coefficient | Range: 0.0~100.0% | 90.0% |
|---------------|--|--------------------------|--------------|

The bigger value of F19.43, the more obvious the suppression will be, but the load response will be slow, the parameter is available when F00.24=1 or 2.

When the load fluctuation is strong, the devices like crusher, punch, pipe file machine and the equipment with clutch will be over-voltage easily, so increasing the parameter is needed.

| | | | |
|---------------|-----------------|--|--|
| F19.44 | Reserved | | |
|---------------|-----------------|--|--|

7.21 Internal Virtual Input Output Node Parameter Group: F20

| | | | |
|---------------|--|--------------------|----------|
| F20.00 | Virtual input VDI1 function selection | Range: 0~90 | 0 |
| F20.01 | Virtual input VDI2 function selection | Range: 0~90 | 0 |
| F20.02 | Virtual input VDI3 function selection | Range: 0~90 | 0 |
| F20.03 | Virtual input VDI4 function selection | Range: 0~90 | 0 |
| F20.04 | Virtual input VDI5 function selection | Range: 0~90 | 0 |

VDI1 to VDI5 have the same functions as Xi terminals on the control board and can be used for digital input. For more details, see description of F08.18 to F08.25. The realization of the function set by internal virtual terminal must be based on the available terminal function.

| | | | |
|---------------|---|--------------------|----------|
| F20.05 | Virtual output VDO1 function selection | Range: 0~60 | 0 |
| F20.06 | Virtual output VDO2 function selection | Range: 0~60 | 0 |
| F20.07 | Virtual output VDO3 function selection | Range: 0~60 | 0 |
| F20.08 | Virtual output VDO4 function selection | Range: 0~60 | 0 |
| F20.09 | Virtual output VDO5 function selection | Range: 0~60 | 0 |

VDO functions are similar to the Yi functions on the control board. The VDO can be used together with VDIx to implement some simple logic control.

If VDO function is set to non-0, the function setting and use of VDOx are the same as the output of parameter of Yi. Please refer to descriptions in group F09.

| | | | |
|---------------|---|----------------------------|--------------|
| F20.10 | Virtual output VDO1 open delay time | Range: 0.00~600.00s | 0.00s |
| F20.11 | Virtual output VDO2 open delay time | Range: 0.00~600.00s | 0.00s |
| F20.12 | Virtual output VDO3 open delay time | Range: 0.00~600.00s | 0.00s |
| F20.13 | Virtual output VDO4 open delay time | Range: 0.00~600.00s | 0.00s |
| F20.14 | Virtual output VDO5 open delay time | Range: 0.00~600.00s | 0.00s |
| F20.15 | Virtual output VDO1 close delay time | Range: 0.00~600.00s | 0.00s |
| F20.16 | Virtual output VDO2 close delay time | Range: 0.00~600.00s | 0.00s |
| F20.17 | Virtual output VDO3 close delay time | Range: 0.00~600.00s | 0.00s |
| F20.18 | Virtual output VDO4 close delay time | Range: 0.00~600.00s | 0.00s |

| | | | |
|---------------|---|----------------------------|--------------|
| F20.19 | Virtual output VDO5 close delay time | Range: 0.00~600.00s | 0.00s |
|---------------|---|----------------------------|--------------|

F20.10~ F20.19 definite the time of open up and shut down terminal VDO1~VDO5 definite is the delay time of internal level from open up to shut down.

| | | | |
|---------------|---|---------------------|-----------|
| F20.20 | Virtual input VDI enable control | Range: 00~FF | 00 |
|---------------|---|---------------------|-----------|

Parameter F20.20 is to control VDI1~VDI5 is enable. F20.20(BIT0-BIT4) is according to the enable unit VDI1~VDI5,0 stands for disabled , 1 stands for enable. The relations are below:

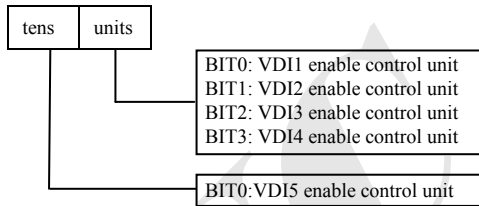

| | | | |
|---------------|---|---------------------|-----------|
| F20.21 | Virtual input VDI status digital setup | Range: 00~FF | 00 |
|---------------|---|---------------------|-----------|

Virtual input terminal VDI state is determined by the VDI F20.21 definite virtual input VDI state Digital and virtual output terminal VDO state, the relation between them is logical OR.

Parameter F20.21 BIT0-BIT4 is according to VDI1~VDI5 state, 0 stands for disabled state, 1 stands for enabled state.

| | | | |
|---------------|---|---------------------|-----------|
| F20.22 | Virtual input: output connection | Range: 00~FF | 00 |
|---------------|---|---------------------|-----------|

Bit0 : The connection of VDI1 and VDO1

0 : positive logic.

1 : negative logic.

Bit1 : The connection of VDI2 and VDO2

0 : positive logic.

1 : negative logic.

Bit2 : The connection of VDI3 and VDO3

0 : positive logic.

1 : negative logic.

Bit3 : The connection of VDI4 and VDO4

0 : positive logic.

1 : negative logic.

Bit4 : The connection of VDI5 and VDO5

0 : positive logic.

1 : negative logic.

Parameter F20.22 definite logical relation if the virtual output terminal, Bit0~Bit4 is according to logical relation setting of VDI1~VDI5 and VDO1~VDO5 , 0 stands for positive logic , 1 stands for negative logic.



Note

Parameter F20.21 definition VDI state , the Digital setting will not influence by F20.22.

7.22 Reserved parameter group 2:F21

| | | | |
|-----------------------|----------|--|--|
| F21.00 ~ F21.21 | Reserved | | |
|-----------------------|----------|--|--|

7.23 Reserved parameter group 3:F22

| | | | |
|-----------------------|----------|--|--|
| F22.00 ~ F22.17 | Reserved | | |
|-----------------------|----------|--|--|

7.24 Reserved parameter group 4:F23

| | | | |
|-----------------------|----------|--|--|
| F23.00 ~ F23.17 | Reserved | | |
|-----------------------|----------|--|--|

7.25 Reserved parameter group 5:F24

| | | | |
|-----------------------|----------|--|--|
| F24.00 ~ F24.13 | Reserved | | |
|-----------------------|----------|--|--|

7.26 User Definition Display Parameter Group: F25





| | | | |
|--------|-----------------------|----------------------|-------|
| F25.00 | User function code 1 | Range: F00.00~F25.xx | 25.00 |
| F25.01 | User function code 2 | Range: F00.00~F25.xx | 25.00 |
| F25.02 | User function code 3 | Range: F00.00~F25.xx | 25.00 |
| F25.03 | User function code 4 | Range: F00.00~F25.xx | 25.00 |
| F25.04 | User function code 5 | Range: F00.00~F25.xx | 25.00 |
| F25.05 | User function code 6 | Range: F00.00~F25.xx | 25.00 |
| F25.06 | User function code 7 | Range: F00.00~F25.xx | 25.00 |
| F25.07 | User function code 8 | Range: F00.00~F25.xx | 25.00 |
| F25.08 | User function code 9 | Range: F00.00~F25.xx | 25.00 |
| F25.09 | User function code 10 | Range: F00.00~F25.xx | 25.00 |
| F25.10 | User function code 11 | Range: F00.00~F25.xx | 25.00 |
| F25.11 | User function code 12 | Range: F00.00~F25.xx | 25.00 |
| F25.12 | User function code 13 | Range: F00.00~F25.xx | 25.00 |
| F25.13 | User function code 14 | Range: F00.00~F25.xx | 25.00 |
| F25.14 | User function code 15 | Range: F00.00~F25.xx | 25.00 |
| F25.15 | User function code 16 | Range: F00.00~F25.xx | 25.00 |
| F25.16 | User function code 17 | Range: F00.00~F25.xx | 25.00 |
| F25.17 | User function code 18 | Range: F00.00~F25.xx | 25.00 |
| F25.18 | User function code 19 | Range: F00.00~F25.xx | 25.00 |
| F25.19 | User function code 20 | Range: F00.00~F25.xx | 25.00 |
| F25.20 | User function code21 | Range: F00.00~F25.xx | 25.00 |
| F25.21 | User function code 22 | Range: F00.00~F25.xx | 25.00 |
| F25.22 | User function code 23 | Range: F00.00~F25.xx | 25.00 |
| F25.23 | User function code 24 | Range: F00.00~F25.xx | 25.00 |
| F25.24 | User function code 25 | Range: F00.00~F25.xx | 25.00 |
| F25.25 | User function code 26 | Range: F00.00~F25.xx | 25.00 |
| F25.26 | User function code 27 | Range: F00.00~F25.xx | 25.00 |

| | | | |
|---------------|------------------------------|-----------------------------|--------------|
| F25.27 | User function code 28 | Range: F00.00~F25.xx | 25.00 |
| F25.28 | User function code 29 | Range: F00.00~F25.xx | 25.00 |
| F25.29 | User function code 30 | Range: F00.00~F25.xx | 25.00 |

This parameter is the User-defined parameter, user can choose the at most 30 from F0 to F30 that are reflect into F25, in order to check and alter more convenient.

Use F25.00 setting the first function code parameter that users plan to. then use F25.01 setting the second function code parameter that users plan to, so after the maximum 30 User-defined parameter that can define is finished, then setting F00.00=3(user list view, press ). If users want to drop out user-defined parameter mode, setting F00.00≠3, then press.

For example: user plan to set three User-defined parameter :F02.01,F03.02 和 F04.00 , following the steps below :

- (1)Use F25.00 to set the first function code parameter02.01, press  ;
- (2)Use F25.01 to set the second function code parameter03.02, press  ;
- (3)Use F25.02 to set the third function code parameter04.00, press  .
- (4)Set F00.00=3(user list view, press ).

After the setting is finished , if users do not change F00.00 function code, when enter function code display state, the operation panel will display F00.00,F02.01,F03.02 and F04.00 only, if the user do not want to display User-defined parameter, setting F00.00 to the display expected mode.



Note

1. xx represent function code.
- 2.F25.xx represent no reflection.



Note

When the setting function parameter is not available into the range of EN500/EN600 permit, setting the User-defined parameter will not make effective.

7.27 Fault Record Function Parameter Group: F26

| | | | |
|--------|------------------------------|-------------|---|
| F26.00 | The last fault record | Range: 0~50 | 0 |
| F26.01 | The last two fault records | Range: 0~50 | 0 |
| F26.02 | The last three fault records | Range: 0~50 | 0 |
| F26.03 | The last four fault records | Range: 0~50 | 0 |

0:No fault.

1~26: E-01~E-26 fault.

27~29: Reserved.

30~40: E-30~E-40 fault.

41~50: Reserved.

F26.00~F26.03 definite the four times previous four code of faults and the two times previous fault for the voltage, current terminal and etc of inverter , users base on fault code and refer to fault function& fault handle process, then getting the results for different types of fault and reasons.

| | | | |
|--------|---|------------------------------------|--------|
| F26.04 | Setup frequency at the last one fault | Range:0.00Hz~upper limit frequency | 0.00Hz |
| F26.05 | Output frequency at the last one fault | Range:0.00Hz~upper limit frequency | 0.00Hz |
| F26.06 | Output current at the last one fault | Range: 0.0~6553.5A | 0.0A |
| F26.07 | DC bus voltage at the last one fault | Range: 0.0~6553.5V | 0.0V |
| F26.08 | Module temperature at the last one fault | Range: 0~125℃ | 0℃ |
| F26.09 | Input terminal status at the last one fault | | 0 |
| F26.10 | Accumulated run time at the last one fault | Range: 0~65535min | 0min |
| F26.11 | Setup frequency at the last two fault | Range:0.00Hz~upper limit frequency | 0.00Hz |
| F26.12 | Output frequency at the last two fault | Range:0.00Hz~upper limit frequency | 0.00Hz |
| F26.13 | Output current at the last two fault | Range: 0.0~6553.5A | 0.0A |
| F26.14 | DC busbar voltage at the last two fault | Range: 0.0~6553.5V | 0.0V |
| F26.15 | Module temperature at the last two fault | Range: 0~125℃ | 0℃ |
| F26.16 | Input terminal status at the last two fault | | 0 |

| | | | |
|---------------|---|--------------------------|-------------|
| F26.17 | Accumulated run time at the last two fault | Range: 0~65535min | 0min |
|---------------|---|--------------------------|-------------|

F26.04~F26.17 record the running state of fault for the first and second time before, when Input terminal state at the fault, the terminal state is the whole terminal state after the time delay, including the standard input terminal state and expanded input terminal state .When Virtual terminal communication is set as the terminal panel point , the standard Input terminal state is determined by the actual physical input terminal and Virtual terminal communication .please refer to the details of the Input terminal state :

Bit0:X1(Standard input terminal 1). 1: valid;0: invalid
 Bit1:X2(Standard input terminal 2). 1: valid;0: invalid
 Bit2:X3(Standard input terminal 3). 1: valid;0: invalid
 Bit3:X4(Standard input terminal 4). 1: valid;0: invalid
 Bit4:X5(Standard input terminal 5). 1: valid;0: invalid
 Bit5:X6(Standard input terminal 6). 1: valid;0: invalid
 Bit6:X7(Standard input terminal 7). 1: valid;0: invalid
 Bit7:X8(Standard input terminal 8). 1: valid;0: invalid
 Bit8:EX1(Extended input terminal 1). 1: valid;0: invalid
 Bit9:EX2(Extended input terminal 2). 1: valid;0: invalid
 Bit10:EX3(Extended input terminal 3). 1: valid;0: invalid
 Bit11:EX4(Extended input terminal 4). 1: valid;0: invalid
 Bit12:EX5(Extended input terminal 5). 1: valid;0: invalid
 BIT13:EX6(Extended input terminal 6). 1: valid;0: invalid

7.28 Password and Manufacturer Function Parameter Group: F27



| | | | |
|---------------|----------------------|---------------------------|--------------|
| F27.00 | User password | Range: 00000~65535 | 00000 |
|---------------|----------------------|---------------------------|--------------|

User password setting function is used for preventing unauthorized persons from checking and modifying the functional parameters.



Set F27.00 to 00000 if the user password function is unnecessary.

If user password function is necessary, input a 5-digit non-zero figure, and press  to confirm. The password is effective at once.

To change the password:

Press  and input the primary password, select F27.00 (F27.00=00000 at the moment), then input new password and press  to confirm. The password is effective at once.

To cancel the password:

Press  into the state of verification, and enter the original correct 5-digit password into the state of parameter editing, then select F27.00 (F27.00=00000 at the moment), and directly press  to confirm, the password can be canceled.



Note

Please memorize the password. Seeking advice from manufacturer in case it is lost.

| | | | |
|---------------|------------------------------|---------------------------|--------------|
| F27.01 | Manufacturer password | Range: 00000~65535 | 00000 |
|---------------|------------------------------|---------------------------|--------------|

Factory setting function, the user can't modify.

8 Troubleshooting

8.1 Failure and countermeasure

Possible failure types in EN500/EN600 are shown in Table 8-1, the fault types including fault and alarm two kinds. Such as if inverter fault display E-XX, while the corresponding alarm is displayed in A-XX. Once the inverter failure, fault types are stored in the F26 fault recording parameter group, and if alarm, alarm status has been revealed, until the alarm source release, alarm status are not logged to the F26 parameter group. Some failure code is reserved for intelligent automatic diagnosis function which will be executed continuously in future. When failure takes place in the inverter, the user should check according to note of these table first and record failure phenomena detailedly. Please contact our after-sale service and technical support Department or agent in your local place when technical service is needed.

Table 8-1 Failure type and the countermeasure

| Failure code | Failure type | Possible reason | Countermeasure |
|--------------|---|---|--|
| E-01 | Overcurrent during accelerating process | Accelerating time is too short | Prolong accelerating time |
| | | Improper V/F curve | Adjust V/F curve setting, adjust manual torque boost or change to automatic torque boost |
| | | Restart rotating motor | Set speed checking restart function |
| | | Low power source voltage | Check input power supply |
| | | Too small power of the inverter | Choose inverter with high-power |
| | | Output phase lose under vector control | Check whether the motor wiring is in good condition |
| E-02 | Overcurrent during decelerating process | Decelerating time is too short | Prolong decelerating time |
| | | Have potential energy load or big Inertia load | Increase braking power of external energy consumption braking subassembly |
| | | Power of inverter is a bit small | Choose inverter with high-power |
| E-03 | Overcurrent during constant speed process | Load change suddenly or have unwonted phenomena | Check or reduce saltation of the load |
| | | Acc./Dec. time is set to too short | Prolong accelerating /decelerating time properly |
| | | low power source voltage | Check input power supply |
| | | Power of inverter is a bit small | Choose inverter with high-power |
| E-04 | Overvoltage during accelerating process | Unwonted input voltage | Check input power supply |
| | | Acc. time is set to too short | Prolong accelerating time properly |

| | | | |
|-------------|---|---|---|
| | | Restart rotating motor | Set speed checking restart function |
| E-05 | Overvoltage during decelerating process | Decelerating time is too short | Prolong decelerating time |
| | | Have potential energy load or big inertia load | Increase braking power of external energy consumption braking subassembly |
| E-06 | Overvoltage during constant speed process | Unwanted input voltage | Check input power supply |
| | | Acc/Dec time is set to too short | Prolong accelerating decelerating time properly |
| | | Input voltage change abnormally | Assemble reactor |
| | | Load inertia is a bit big | Use energy consumption subassembly |
| E-07 | Inverter control power supply overvoltage | Unwanted input voltage | Check input power supply or look for service |
| E-08 | Low-voltage when running | Input voltage is too low | Check the input voltage |
| E-09 | Inverter overload protection | Acc time is set to too short | Prolong accelerating time |
| | | DC injection braking is too big | Reduce DC injection braking current, prolong braking time |
| | | improper V/F curve | Adjust V/F curve and torque boost |
| | | Restart rotating motor | Set speed checking restart function |
| | | power source voltage is too low | check power source voltage |
| | | Load is too big | Choose inverter with high-power |
| E-10 (A-10) | Motor overload protection | Improper V/F curve | Adjust V/F curve and torque boost |
| | | Power source voltage is too low | check power source voltage |
| | | General motor run at low speed with big load | Can choose frequency conversion motor for long time low speed run |
| | | Motor overload protection factor set incorrectly | to set motor overload protection factor correctly |
| | | Motor blocked up or load change too suddenly and quickly | Check the load |
| E-11 (A-11) | Motor underload protection | The operating current of inverter less than underload threshold | Confirm whether the parameters F19.08, F19.09 setting are reasonable |
| | | load divorced from motor | Checking whether the load divorced from motor |
| E-12 | The input phase lose | The three-phase input power supply is abnormal | Check the three-phase input power line is off or poor contact |

| | | | |
|-------------|--|---|--|
| | | Power supply board anomaly | Look for service from manufacturer or agent |
| | | The control board anomaly | Look for service from manufacturer or agent |
| E-13 | The output phase lose | Anomaly wire between motor and inverter | Check the motor wire |
| | | When the motor runs inverter three-phase output unbalanced | Check whether the motor three-phase winding is balance |
| | | Power supply board anomaly | Look for service from manufacturer or agent |
| | | The control board anomaly | Look for service from manufacturer or agent |
| E-14 | Inverting module protection | Transient overcurrent of the inverter | Refer to countermeasure for overcurrent |
| | | phase to phase short circuit or earthing short circuit of output 3 phase | wiring again |
| | | Air-path blocked or fan damaged | To clear air-path or replace the fan |
| | | Ambient temperature is too high | Lower ambient temperature |
| | | Connecting wire or insert on control board loose | Check and connect the wire again |
| | | Unwonted current wave caused by missing output phase etc. | Check wiring |
| | | Assistant power supply damaged and drive voltage lacking | Look for service from manufacturer or agent |
| | | Unwonted control board | Look for service from manufacturer or agent |
| E-15 | Short circuit to ground when operation | Motor short circuit to ground | The replacement of cable or motor |
| | | Hall component is damaged or the hall wiring is poor or the current detection circuit is abnormal | Look for service from manufacturer or agent |
| E-16 | Short circuit to ground when power on | Motor short circuit to ground | Change the cable or motor |
| | | The power supplier of the inverter and the motor wiring are reversed | Change the cable or motor wiring |
| | | Hall component is damaged or the hall wiring is poor | Look for service from manufacturer or agent |
| E-17 (A-17) | Inverter overheat | Continuous alarm on A-17 for more than 30 minutes | Cleaning or to improve the ventilation duct |
| | | Duct blockage | Cleaning or to improve the ventilation duct |

| | | | |
|----------------|-----------------------------------|---|--|
| | | The ambient temperature is too high | To improve the ventilation conditions, decreasing the carrier frequency |
| | | Fan damage | Change new one |
| E-18 (A-18) | External device failure | Sudden stop terminal for external failure closed | Open external failure terminal after external failure is settled |
| E-19 | Current detecting circuit failure | Connecting wire or insert on control board loose | Check and connect the wire again |
| | | Assistant power supply damaged | Look for service from manufacturer or agent |
| | | Hall component damaged | Look for service from manufacturer or agent |
| | | Unwonted amplifying circuit | Look for service from manufacturer or agent |
| E-20 | External interference failure | The interruption protection of CPU is triggered, but none of the actual overcurrent, overvoltage and short circuit signals have been detected | Press "STOP/RESET" button to reset or add external power supply filter from power input side |
| E-21 | Internal interference failure | Internal disturbance serious | Power off and restart, if the failure persists, seek the manufacturer or dealer service |
| E-22 (A-22) | PID given loss | PID given loss threshold setting is not reasonable | To reset the relevant parameters |
| | | External given disconnection | Check external given wiring |
| | | The control board anomaly | Look for service from manufacturer or agent |
| E-23 (A-23) | PID feedback loss | PID feedback loss threshold setting is not reasonable | To reset the relevant parameters |
| | | Feedback signal disconnection | Check external feedback signal wiring |
| | | The control board anomaly | Look for service from manufacturer or agent |
| E-24 (A-24) | PID error amount abnormal | PID error abnormal detection threshold setting is not reasonable | To reset the relevant parameters |
| | | The control board anomaly | Look for service from manufacturer or agent |
| E-25 | Start terminal protection | Terminal command effective when power on . | Check the external input terminal state |
| E-26 (A-26) | Communication failure | Baud rate set improperly | set Baud rate properly |
| | | Serial port communication error | Press "STOP/RESET" key to reset, look for service |
| | | Failure warning parameter set improperly | Modify F05.04, F05.05 |

| | | | |
|----------------|--|---|---|
| | | Upper device doesn't work | Check if upper device work and wiring is correct |
| E-27 | Reserved | | |
| E-28 | Reserved | | |
| E-29 | Reserved | | |
| E-30 (A-30) | E ² PROM read and write wrongly | Mistake take place when read or write control parameter | Reset by pressing "STOP/RESET" Look for service from manufacturer or agent |
| E-31 | Temperature detecting disconnection | Temperature sensor fault | Look for service from manufacturer or agent |
| | | The temperature detection circuit anomaly | Look for service from manufacturer or agent |
| E-32 | Self tuning failure | Parameter setting not according to the motor nameplate | set parameter correctly according to the motor nameplate |
| | | current anomaly when tuning | Select inverter match the motor |
| | | Motor wiring error | Check the motor three-phase wiring |
| E-33 (A-33) | Contactor anomaly | Power board anomaly | Look for service from manufacturer or agent |
| | | Contactor anomaly | Replace contactor |
| E-34 | The factory fault 1 | Debugging use in factory | |
| E-35 | The factory fault 2 | Debugging use in factory | |
| E-36 (A-36) | The bus capacitor overheating | Poor cooling environment | Improve the inverter heat dissipation environment |
| | | The inverter capacity is too small | Select inverter match motor |
| | | Bus capacitance cooling fan is damaged | Replace the bus capacitor cooling fan |
| E-37 | Encoder disconnection | Damaged encoder or poor wiring | Check the wiring or the encoder |
| E-38 | Overspeed protection | Short acceleration time | Prolong the acceleration time |
| | | Low inverter power | Select high-power inverter |
| | | Overspeed detect parameter F19.39 and F19.40 is set improperly | Set the parameter properly according to the situation |
| E-39 | Large speed deviation protection | Short Acceleration/ deceleration time | Prolong the acceleration time |
| | | Low inverter power | Select high-power inverter |
| | | Over velocity misalignment. Parameter F19.41 and F19.42 is set improperly | Set the parameter properly according to the situation |
| E-40 | Fault of Z pulse loses | Z signal wire of motor coder is unconnected or loose. | Check the Z signal wire of motor coder. |
| E-41 | Analog channel disconnected | AI1 or AI2 detection of the physical quantity is not within a reasonable range, or AI1 or AI2 circuit contact bad | Control the AI1 or AI2 measurement of physical quantities reasonably, check AI1 or AI2 wiring |

| | | | |
|-------------------|--|--|--|
| E-42 ~ E-50 | Reserved | | |
| A-51 | The main and auxiliary given frequency channel exclusiveness alarm | Parameter setting error | F01.00 and F01.03 cannot be set to the same channel (9: terminal encoder given except) |
| A-52 | Terminal function exclusiveness alarm | Terminal parameters setting repeatedly | function Check the terminal function settings |
| A-53 | Operation limit alarm | Limit run time | Please contact supplier |
| LOCH1. | Keypad lock | Keypad lock | Press  key for more than 2s to unlock the keypad. |



Note

- 1, Alarm fault of E-16, the inverter must be power off for reset.
- 2, For the faults of over-current, short-circuit to ground while running, inverter can reset after 2s's delay
- 3, When alarm fault of E-09, the reset time of inverter types over 75kw (including 75kw) is 10s; for 55kw (including 55kw), the time is 4s.

8.2 Failure record lookup

This series inverter can record latest 4 failure code and inverter run parameter of the last 2 times failure, refer to these information can redound to finding out reason of the failure.

Failure information is all stored in F26 group parameter, please enter into F26 group parameter to see about information by referring to keypad operation method.

| Code | Content | Code | Content |
|--------|------------------------------------|--------|--|
| F26.00 | Previous one failure record | F26.09 | Input terminal state at previous failure |
| F26.01 | Previous two failure record | F26.10 | Running time at previous failure |
| F26.02 | Previous three failure record | F26.11 | Set freq. at previous 2 failure |
| F26.03 | Previous four failure record | F26.12 | Output freq. at previous 2 failure |
| F26.04 | Set freq. at previous failure | F26.13 | Output current at previous 2 failure |
| F26.05 | Output freq. at previous failure | F26.14 | DC bus volt. at previous 2 failure |
| F26.06 | Output current at previous failure | F26.15 | Module temp. at previous 2 failure |

| | | | |
|--------|----------------------------------|--------|--|
| F26.07 | DC bus volt. at previous failure | F26.16 | Input terminal state of previous 2 failure |
| F26.08 | Module temp. at previous failure | F26.17 | Running time of previous 2 failure |

8.3 Failure reset



- 1. Before reset you must find out reason of failure downright and eliminate it, otherwise may cause permanent damage to the inverter.**
- 2. If can't reset or failure takes place again after resetting, should look for reason and continuous resetting will damage the inverter.**
- 3. Reset should take place 5 minutes later after overload, overheat protection action.**
- 4. For the fault of E-14, the reset is invalid, the motor wiring should be checked after power off, and restart the inverter.**
- 5. When there is a fault of E-16 after power on, do not directly run the inverter after reset, and need to check whether the input, out wiring are reversed.**

To resume normal running when failure takes place in the inverter, you can choose following any kind of operation:

- (1) After you set any terminal of X1~X8 to be inputted by external RESET, it will be reset after connected to COM.
- (2) When failure code is displayed, press  key after confirmed that it can be restoration.
- (3) Communication reset. Please refer to annex description.
- (4) Cut off power supply.

8.4 Alarm reset

When an alarm occurs, must eliminate alarm source which cause alarm, otherwise the alarm cannot be eliminated, also cannot be reset by reset button.

9 Maintenance

9.1 Routine maintenance

When you use this series you must assemble and operate it according to demand listed in this “service manual” strictly. During run state, temperature, humidity, vibration and aging parts will affect it, which may cause failure of the inverter. To avoid this, it is recommended to perform routine inspections and maintenance.

Table 9-1 Daily inspection and maintenance items

| Period | | Inspection item |
|--------|----------|--|
| Daily | Periodic | |
| √ | | Daily cleaning: (1) Inverter should be maintained in a clean state (2) Clean up the dust on the surface of inverter, prevent the dust into the inverter internal (especially metal dust). (3) Clean up the oil stain of cooling fan |
| | √ | Check the air duct, and regularly clean. |
| | √ | Check whether the screws is loose |
| | √ | Check whether the inverter is corrode |
| √ | | Whether inverter installation environment changes |
| √ | | Whether the inverter cooling fan is working properly |
| √ | | Whether the inverter is overheating |
| √ | | When running whether voice of motor abnormal change. |
| √ | | Whether occur abnormal vibration when motor running |
| | √ | Check wiring terminals have arc trace |
| | √ | The main circuit insulation test |

Recommend to inspect with following instrument:

Input voltage: electric voltmeter; output voltage: rectifying voltmeter; input output current: pincers ammeter.

9.2 Inspection and replacement of damageable parts

Some component parts in the inverter will be abraded or bear descending performance for long-term usage, to assure that the inverter can run stably and reliably, it is recommended to perform defending maintenance and replace corresponding parts if necessary.

(1) Cooling fan

Abnormal noise, even oscillation may take place if the fan have wearing bearing, aging blade, here replacement of the fan should be considered.

(2) Filter electrolyte capacitance

When frequent-changing load causes increasing pulsant current and aging electrolyte under high ambient temperature, the electrolyte capacitance may be damaged and here should replace it.

9.3 Repair guarantee

(1) We provide the free maintenance within warranty time if any failure or damage under normal usage, the warranty time can be seen in the warranty card, we will charge some when exceed warranty time.

(2) We will take some upkeep if one of following situations takes place within period of repair guarantee.

a. If did not use the inverter according to *service manual* strictly or did not use it under ambient demanded in *service manual*, which cause failure.

b. Failure caused by applying the inverter to non-normal function;

c. Failure caused by self-repair, refit which is not already allowed;

d. Damage caused by bad keeping, falling down from high place or other extrinsic factor after purchasing the inverter;

e. Failure caused by natural disaster or its reason such as unwonted voltage, thunderbolt, water fog, fire, salt corroding, gas corroding, earthquake and storm etc.;

f. Make bold to tear up product logo (such as: nameplate etc.); Body serial number don't accord with that in repair guarantee card.

(3) We calculate service fee based on actual cost, which is subject to contract if any.

(4) You can contact the agent and also our company directly if you have questions. After repair guarantee period, we shall also provide lifetime charged repair service for our products.



Note

Our company will also provide lifetime repair service with fee for inverter which is not within period of repair guarantee.

9.4 Storage

The user must pay attention to following points for temporary storage and long-term storage after purchasing the inverter:

- (1) Avoid storing the inverter in high temperature, moist place and place of dust, metal powder and assure good ventilation.
- (2) Longtime storage will cause low quality of electrolyte capacitance, so must assure that it's electrified for one time within 1 year and electrification time is not shorter than 1 hour and input voltage must be increased to rated value gradually by voltage regulator of 250w, meanwhile the inverter should be cut off from the motor.

ENC

Appendix A Modbus communication protocol

A.1 Summary

We provide general RS485 communication interface in our inverters for the user. Through this communication interface upper device (such as HMI, PC, PLC controller and etc.) can perform centralized monitor to the inverter (such as to set inverter parameter, control run of inverter, read work state of the inverter).

This communication protocol is interface criterion file designed for realizing above-mentioned function, please read it earnestly and program according to it so that realize long-distance and network control to the inverter.

A.2 Communication net buildup mode

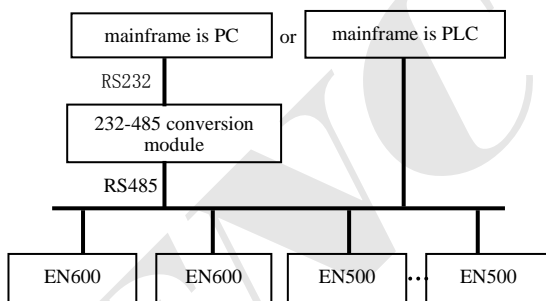

Fig.A-1 net buildup graph

A.3 Communication mode

At present, EN500/EN600 inverter can be used only as Slave device in RS485 net. Can realize communication between inverters through PC, PLC or HMI if it's needed. Specific communication mode is as mentioned below:

- (1) PC or PLC as mainframe, inverter as Slave device, point-to-point communication between mainframe and Slave device.
- (2) Slave device don't response when mainframe send out command by broadcast address.
- (3) User can set local address, baud rate and data format of the inverter through Slave device keypad or serial communication mode.
- (4) EN500/EN600 provides the RS485 interface.
- (5) Default mode: Asynchronous serial, semiduplex transport mode. There are RTU and ASII two mode . Default format and transport rate: 8-N-1, 9600bps.

A.4 Transmission mode

Asynchronous serial, semiduplex transport mode. Default format and transport rate: 8-N-1, 9600bps. The detail setting parameter, please refer to the F05 group function mode.

(Remark: the parameter is valid under the Modbus communication, the other parameter comply with the original service manual)

| | | | | | |
|--------|--------------------|---|---|-----|---|
| F05.00 | Protocol selection | 0:Modbus protocol 1:Reserved 2:Profibus protocol(expansion is valid) 3:CanLink protocol(expansion is valid) 4:CANopen protocol(expansion is valid) 5:free protocol 1(revision all the parameter of EN500/EN600 is valid) 6: free protocol 2(only revising part parameter of EN500/EN600 is valid) Remark: expansion card is needed when select 2,3,4 communication | 1 | 0 | × |
| F05.01 | Baud rate setting | Units digit: free protocol and Modbus Baud rate selection 0:300BPS 1:600BPS 2:1200BPS 3:2400BPS 4:4800BPS 5:9600BPS 6:19200BPS 7:38400BPS 8:57600BPS | 1 | 005 | × |
| F05.02 | Data format | Units digit: free protocol and Modbus protocol Data format 0:1-8-1 format, no checkout, RTU 1:1-8-1 format, Odd Parity, RTU 2:1-8-1 format, Even Parity, RTU 3:1-7-1 format, no checkout, ASCII 4:1-7-1 format, Odd Parity, ASCII 5:1-7-1 format, Even Parity, ASCII | | 00 | × |
| F05.03 | Local address | 0~247, 00 is broadcast address | 1 | 1 | × |

A.5 Data communication structure

A.5.1 Data frame format

Using RTU mode, messages are sent at least 3.5 character time interval pause. The first transmitted field is device address, the character you can transfer is hexadecimal 0x00 ~ 0xFF. Network equipment continuously monitor the bus, including pauses. When the address field is received, all equipment determine whether it is sent to their own. when the last character of the packet transfer is complete, at least a 3.5 character times pause mean the end of the message. A new

message can begin after this pause.

The entire message frame must be transmitted as a continuous flow. If a new message start transmitting in less than 3.5 character times after a message and then receiving device will consider it a continuation of the previous message. This will cause an error, because in the final CRC field value can not be right.

RTU frame format as the table below:

| | |
|----------------------------|--|
| Frame Header | 3.5 characters time pause |
| Slave address | Slave address:0~247 |
| Communication command code | 03H:read slave parameter 06H:write slave parameter |
| Data content DATA | The contents of packet; Parameter address(16bit); Number of parameter or bytes of parameter value; Parameter value(16bit) |
| Data content DATA | |
| | |
| | |
| CRC check value low byte | |
| CRC check value high byte | 16bit Unsigned check value |
| Closing Flag | 3.5 characters time pause |

Regarding generation method of CRC check value, please refer to Section A.9.

ASCII frame format as the table below:

| | |
|-------------------|---|
| Frame Header | ':'(0x3A) |
| Slave address Hi | Slave address: Combined by 2 ASCII code |
| Slave address Lo | 8 bit slave address 0~247 |
| Command code Hi | Command code: 8 bit command code combined by 2 ASCII code |
| Command code Lo | 03H:read slave parameter 06H:write slave parameter |
| Data content DATA | The contents of data packet: |
| Data content DATA | N pieces of 8bit data content combined by 2*N pieces of ASCII code |
| | |
| | |
| LRC CHK Hi | LRC check value includes 2 pieces of ASCII code |
| LRC CHK Lo | |
| Closing Flag Hi | Closing Flag Hi = CR(0x0D) |
| Closing Flag Lo | Closing Flag Lo = LF(0x0A) |

A.5.2 Host read slave parameter

Command code 03H. Host can read one or more parameter(up to ten) by initiating a communication transaction .

E.g., read 2 contiguous inverter parameter values from the address 0000H of inverter whose address is 01, the contents of host command :

| | |
|--------------------------------------|-----|
| ADR | 01H |
| CMD | 03H |
| Parameters initial address high byte | 00H |
| Parameters initial address low byte | 00H |
| Number of parameter high byte | 00H |
| Number of parameter low byte | 02H |
| CRC check value low byte | C4 |
| CRC check value high byte | 0B |

The contents of slave reply:

| | |
|---------------------------------|-----|
| ADR | 01H |
| CMD | 03H |
| Parameter value bytes | 04H |
| Address 0000H content high byte | 00H |
| Address 0000H content low byte | 00H |
| Address 0001H content high byte | 00H |
| Address 0001H content low byte | 03H |
| CRC check value low byte | BA |
| CRC check value high byte | F2 |

A.5.3 Host write slave parameter

Command code 06H. Host can write an parameter by initiating a communication transaction .

E.g.,The decimal system 5000 (1388H) written to the inverter 0101H address whose slave address is 02, host command including:

| | |
|-----------------------------|-----|
| ADR | 02H |
| CMD | 06H |
| Parameter address high byte | 01H |
| Parameter address low byte | 01H |
| Parameter value high byte | 13H |
| Parameter value low byte | 88H |
| CRC check value low byte | D4 |
| CRC check value high byte | 93 |

The contents of slave reply:

| | |
|---------------------------------|-----|
| ADR | 02H |
| CMD | 06H |
| Parameter address high byte | 01H |
| Parameter address low byte | 01H |
| Address 0101H content high byte | 13H |
| Address 0101H content low byte | 88H |
| CRC check value low byte | D4 |
| CRC check value high byte | 93 |

A. 6 Data communication address allocation

A.6.1 Function code F00-F26 group communication address

Inverter function parameter's MODBUS communication address addressing process follows PPnn way: PP means high byte of the address, corresponding to function parameter's group number; nn means low byte of the address, corresponding to function code parameter's group internal code. For example: F3.21 function code's communication address is 0315H, 03H is the hex form of group number 3, 15H is the hex form of group internal code 21.

F00.00~F26.17 communication address is 0000H~1A11H, F26 group fault record parameter start address is 1A00H.

A.6.2 control command and status word communication address

| Variable Name | Communication address | Reading-writing attribute | Command data or response value meaning |
|---------------------------|-----------------------|---------------------------|--|
| Run command word | 1 E 00H | Reading and writing | 1: reserved |
| | | | 2: Jog stop command |
| | | | 3: forward JOG run |
| | | | 4: reversal JOG run |
| | | | 5: run |
| | | | 6: stop |
| | | | 7: forward run |
| | | | 8: reversal run |
| | | | 9: fault reset |
| | | | 10: reserved |
| Serial port value setting | 1E 01H | Reading and writing | F01.02 while hundreds place=0: 5000 represents 50.00Hz F01.02 while hundreds place=1: 10000 represents F01.11 |
| Inverter status | 1E 02H | Reading only | BIT0: bus voltage set BIT1: the ordinary run command effectively BIT2: JOG command effectively BIT3: Running BIT4: the current running direction is reverse BIT5: the operating instructions is reverse direction BIT6: deceleration braking BIT7: acceleration BIT8: deceleration BIT9: alarm BIT10: fault BIT11: current limit BIT12: fault self recovery BIT13: self tuning BIT14: Free stop State BIT15: speed tracking start |

| | | | |
|------------|--------|--------------|---|
| Alarm code | 1E 03H | Reading only | 0: no alarm 1 ~ 50: the current alarm code |
|------------|--------|--------------|---|



Note

Modbus communication address: 1E01 is the given address of Frequency-Communication mode; 1D01 is the given address of Torque-Communication mode; 1D00 is the given address of PID-Communication mode.

A.6.3 Monitor parameter communication address

| Variable name | Communication address | read-write attribute | Command data or response value |
|---------------|-----------------------|----------------------|--------------------------------|
| C-00 | 1C00H | Reading | Monitoring parameters 1 |
| C-01 | 1C01H | Reading | Monitoring parameters 2 |
| C-02 | 1C02H | Reading | Monitoring parameters 3 |
| C-03 | 1C03H | Reading | Monitoring parameters 4 |
| C-04 | 1C04H | Reading | Monitoring parameters 5 |
| C-05 | 1C05H | Reading | Monitoring parameters 6 |

A.6.4 Inside hidden parameters

| Variable name | Communication address | read-write attribute | means of command data or response value |
|---|-----------------------|----------------------|---|
| PID Communication presetting value | 1D00H | read-write | Range: 0~1000(1000 represents 10.00V) |
| Torque communication presetting value | 1D01H | read-write | Range:0~2000(2000 represents 200.0% rated motor torque) |
| Communication AO1 given value | 1D02H | read-write | Range: 0~4000(4000 represents 10.00V or 20.00mA) |
| Communication AO2 given value | 1D03H | read-write | Range: 0~4000(4000 represents 10.00V or 20.00mA) |
| Communication EAO1 given value | 1D04H | read-write | Range: 0~4000(4000 represents 10.00V or 20.00mA) |
| Communication EAO2 given value | 1D05H | read-write | Range: 0~4000(4000 represents 10.00V or 20.00mA) |
| Communication DO given value | 1D06H | read-write | Range: 0~4000(4000 represents 10.00V or 20.00mA) |
| Communication EDO given value | 1D07H | read-write | Range: 0~4000(4000 represents 10.00V or 20.00mA) |
| The communication output terminal given value | 1D08H | read-write | BIT0: Y1 BIT1: Y2 BIT2: Y3 BIT3: Y4 BIT4: RLY1 BIT5: EY1 BIT6: EY2 BIT7: EY3 |

| | | | |
|--|-------|------------|---|
| | | | BIT8: EY4 BIT9: ERLY1 BIT10: ERLY2 |
| Communication virtual input terminal given value | 1D09H | read-write | BIT0: CX1 ... BIT7: CX8 |
| Positive torque limited frequency | 1D0AH | read-write | Range: 0~60000(60000 represents 600.00Hz) |
| Negative torque limited frequency | 1D0BH | read-write | Range: 0~60000(60000 represents 600.00Hz) |
| PID feedback voltage | 1D0CH | read-write | Range: 0~4000(4000 represents 10.00V) |
| Reserved | 1D0DH | / | |

A.7 Communication error processing

Inverter receiving data packet detection error, it finds reading&writing parameter address or parameter value invalid, so reply to the host with communication error response packet. Communication error response packet (host command code +80H) as command code, with 1 byte error code.

Format for communication error response packet as follows:

| | |
|---------------------------|---|
| ADR | 01H |
| CMD | 83H/86H |
| Communication error code | 01H~06H (for details, please check below table) |
| Low byte of CRC checksum | Obtain by calculating |
| High byte of CRC checksum | Obtain by calculating |

Meaning for each communication error code value as follows:

| Communication error code value | Communication error type | Priority |
|--------------------------------|----------------------------------|----------|
| 0x01 | CRC checksum error | 1 |
| 0x02 | Command code illegal | 2 |
| 0x03 | Register address visited illegal | 3 |
| 0x04 | Value to register illegal | 4 |
| 0x05 | Not allow to modify parameters | 5 |
| 0x06 | Register number read illegal | 6 |

A.8 Data frames examples

A.8.1 RTU Mode

1. Start #1 inverter running

| Data Field | Slave Address | Order code | Register address High byte | Register address Low byte | Data High byte | Data Low byte | CRC low bit | CRC high bit |
|----------------------|---------------|------------|----------------------------|---------------------------|----------------|---------------|-------------|--------------|
| host command frames | 01 | 06 | 1E | 00 | 00 | 05 | 4F | E1 |
| Slave respond frames | 01 | 06 | 1E | 00 | 00 | 05 | 4F | E1 |

2. Stop #1 inverter running

| Data Field | Slave Inverter Address | Order code | Register address High byte | Register address Low byte | Data High byte | Data Low byte | CRC Low bit | CRC High bit |
|----------------------|------------------------|------------|----------------------------|---------------------------|----------------|---------------|-------------|--------------|
| host command frames | 01 | 06 | 1E | 00 | 00 | 06 | 0F | E0 |
| Slave respond frames | 01 | 06 | 1E | 00 | 00 | 06 | 0F | E0 |

3. Set #1 inverter given value to 50.00Hz

| Data Field | Slave Inverter Address | Order code | Register address High byte | Register address Low byte | Data High byte | Data low byte | CRC low bit | CRC high bit |
|----------------------|------------------------|------------|----------------------------|---------------------------|----------------|---------------|-------------|--------------|
| host command frames | 01 | 06 | 1E | 01 | 13 | 88 | D3 | 74 |
| Slave respond frames | 01 | 06 | 1E | 01 | 13 | 88 | D3 | 74 |

4. Read #1 inverter running state

| Data Field | Slave Inverter Address | Order code | Register address High byte | Register address Low byte | Data High byte | Data low byte | CRC low bit | CRC high bit |
|----------------------|------------------------|------------|-------------------------------------|---------------------------|----------------|---------------|-------------|--------------|
| host command frames | 01 | 03 | 1E | 02 | 00 | 01 | 23 | E2 |
| Slave respond frames | 01 | 03 | (Respond value byte quantity) 02 | | 00 | 01 | 79 | 84 |

- **Ending code:** enter, line break. is:0x0D,0x0A

Response frame

| Response frame format | | | | | | | | | | | | |
|-----------------------|--------------------|---------------|---------------|------------|--------------|---------|-----------|-----------|-------------------|----------|----------|-------------|
| | Frame begin symbol | Slave address | Slave address | Slave code | Command code | Command | Data byte | Data byte | Data string value | checksum | checksum | Ending code |
| Send byte | 1 | 2 | | 2 | | 2 | 2 | | N*2 | 2 | | 2 |

remark:

- **Begin code:**
The lower computer judge the frame of ASCII frame. This is ':'.
- **Slave address:**
Single inverter ID code, range:0~247.
Thereinto, address 0 is broadcast address. Broadcast address can control all the lined Slave simultaneously, and the Slave will not send back any Data to the host. That means the Slave only accept and do not send.
Modbus protocol is without host address.
- **Command code:**
The command of reading parameter or data from inverter, the value is:'0'3'.
- **Data byte:**
The number of parameters read by a frame. It is 4 byte, which is ASCII mode transformed from hexadecimal.
- **Data string value:**
The detail return Data, the length of Data string is the register address "Data byte", which is ASCII mode transformed from hexadecimal. Range: 4~40 byte
- **Checksum:**
From "slave address" to the character before checksum, the LRC checksum of the character string.
The function terminal can be seen in the later text.
- **Ending symbol:** enter, line break. Is 0x0D,0x0A
The followings are the example of command frame and return frame, all the Data are ASCII character.

➤ **Inquiry frame:**

: 0 1 0 3 0 0 0 1 0 0 0 1 F A \n\r

(The detail introduction of every byte)

“:”: beginning symbol

0 1: Slave address**0 3**:read the command**0 0 0 1**:storage address of reading parameter**0 0 0 1**:the number of reading the parameter**FA**:{ **0 1 0 3 0 0 0 1 0 0 0 1** } for LRC checksum.**0xFA = 0x100 - (0x01 + 0x03 + 0x00 + 0x01 + 0x00 + 0x01)**➤ **Response frame:**

: 0 1 0 3 0 2 0 0 3 3 C 7 \n\r

(The detail introduction of every byte)

“:”: beginning symbol

0 1: Slave address**0 3**:read the command**0 2**:The byte length of return parameter Data.**0 0 3 3**:return parameter, current storage value**C 7**:{ **0 1 0 3 0 2 0 0 3 3** } for LRC checksum.**0xC7 = 0x100 - (0x01 + 0x03 + 0x02 + 0x00 + 0x33)****The main frame writes slave address single register, command code: 06****The host frame**

| The host frame format | | | | | | | | | | | | | | | | |
|-----------------------|--------------------|---------------|---------------|---------------|--------------|------------------|------------------|------------------|------------------|------|------|------|------|----------|----------|---------------|
| | Frame begin symbol | Slave address | Slave address | Slave address | Command code | Register address | Register address | Register address | Register address | Data | Data | Data | Data | Checksum | checksum | Ending symbol |
| Send byte | 1 | 2 | 2 | 2 | | 4 | | | | 4 | | | | 2 | | 2 |

Remark:

➤ **Slave address:**

Single inverter ID code, range:0~247.

Thereinto, address 00 is broadcast address.

➤ **Command code:**

Read parameter from inverter or command of Data, the value is:06

➤ **Register address:**

The storage address of inverter function parameter, is double byte.

The high byte is in the front and the low byte is in the back.

The detail relation between parameter and storage address can be seen in the later excel.

➤ **Data:**

The new value of revised parameter.

➤ **Checksum:**

From “slave address” to the character before checksum, the LRC checksum of the character string.

Response frame

| Response frame format | | | | | | | | | | | | | | | | |
|-----------------------|--------------------|---------------|---------------|--------------|--------------|------------------|------------------|------------------|------------------|------|------|------|------|----------|----------|---------------|
| | Frame begin symbol | Slave address | Slave address | Command code | Command code | Register address | Register address | Register address | Register address | Data | Data | Data | Data | Checksum | Checksum | Ending symbol |
| Send byte | 1 | 2 | 2 | 1 | 1 | 2 | 2 | 2 | 2 | 4 | 4 | 4 | 4 | 2 | 2 | 2 |

Remark:

➤ **Slave address:**

Single inverter ID code, range:0~247.

Thereinto, address 00 is broadcast address.

➤ **Command code:**

Read parameter from inverter or command of Data, the value is:06

➤ **Register address:**

The storage address of inverter function parameter, is double byte.

The high byte is in the front and the low byte is in the back.

The detail relation between parameter and storage address can be seen in the later excel.

➤ **Data:**

The new value of revised parameter.

➤ **Checksum:**

From “slave address” to the character before checksum, the LRC checksum of the character string.

The followings are the example of command frame and return frame, all the Data are ASCII character.

➤ **Inquiry frame:**

:0106010113885C\r\n

(The detail introduction of every byte)

“:”: beginning symbol

0 1: Slave address

0 6:write command

0 1 0 1:storage address of writing parameter

1 3 8 8:the value of writing parameter

5 C:{ **0 1 0 6 0 1 0 1 1 3 8 8** } for LRC checksum.

0x5C = 0x100 - (0x01 + 0x06 + 0x01 + 0x01 + 0x13 + 0x88)

➤ **Response frame:**

: 0 1 0 6 0 1 0 1 1 3 8 8 5 C \n\r

(Detail introduction of every byte)

“:”: beginning symbol

0 1: Slave address

0 6:write command

0 1 0 1:storage address of writing parameter

1 3 8 8:the value of writing parameter

5 C:{ **0 1 0 6 0 1 0 1 1 3 8 8** } for LRC checksum.

0x5C = 0x100 - (0x01 + 0x06 + 0x01 + 0x01 + 0x13 + 0x88)

1. ASCII frame realizes transform by that 8Bit hexadecimal is divided as different 2 character of 4, and then grouped as hexadecimal of one 8Bit when reaching the destination.

2. Frame header, add“:”, frame footer adds“\n\r” the enter line break character.

3. The valid character in the protocol is: :, 0,1,2,3,4,5,6,7,8,9,A,B,C, D,E,F and hexadecimal 0DH, lower case ASCII letter a, b, c, d, e, f is invalid

4. The subject data volume is the 2 times as RTU, checksum adopt LRC check.

5.For the other information, please refer to the official standard protocol when need.



Note

A.9 CRC checkout mode

CRC checkout value calculating function written by C language is as follows:

```
unsigned int cal_crc_value (unsigned char *pval, unsigned char len)
{
    unsigned int crc_value=0xFFFF;
    unsigned int i;

    while(len--)
    {
        crc_value ^= *pval++;
        for(i=0; i<8; i++)
        {
            if(crc_value & 0x0001)
            {
                crc_value >>= 1;
                crc_value ^= 0xA001;
            }
            else
            {
                crc_value >>= 1;
            }
        }
    }
    return(crc_value);
}
```

Appendix B Free-port communication protocol

B.1 Summarization

We provide the customer with general RS485/RS232 communication interface in our EN500/EN600 series frequency inverter. For the users, through the communication interface upper device (such as PC, PLC controller etc.) can perform centralized monitor to the inverter (such as setting inverter parameter, controlling run of inverter, reading work state of the inverter) and also long-distance control keypad can be connected to realize diverse operating requirement of the user.

This communication protocol is interface criterion file designed for realizing above-mentioned function, please read it earnestly and program according to it so that realize long-distance and network control to the inverter.

B.2 Protocol content and description

B.2.1 Communication net buildup mode

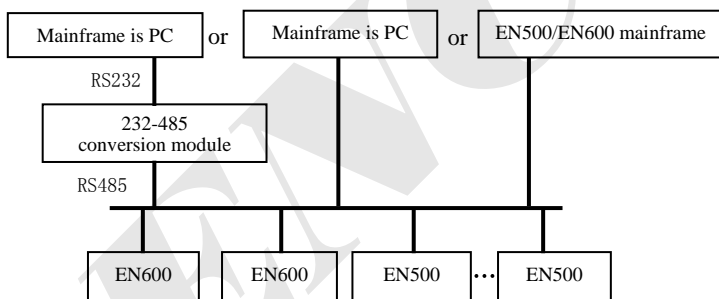

Fig.B-1 net buildup graph

B.2.2 Communication mode

At present, EN500/EN600 inverter can be used as not only auxiliary device but also mainframe device in RS485, if the inverter is used as auxiliary device, master device can be completed by PC, PLC or human interface, and if used as mainframe device, the main- auxiliary control of the inverter can be complement by it. Specific communication mode is as mentioned below:

- (1) PC or PLC as mainframe, inverter as auxiliary device, point-to-point communication between mainframe and auxiliary device.
- (2) Auxiliary device don't response when mainframe send out command by broadcast address.
- (3) User can set local address, baud rate and data format of the inverter through auxiliary device keypad.

(4) Auxiliary device report current failure information to mainframe in the last response frame.

(5) EN500/EN600 provides RS485 interface.

B.2.3 Transport mode

Asynchronous serial, semiduplex transport mode. Default format and transport rate: 8-N-1, 9600bps. For specific parameter setting please see description for F05 group function code.

(Remark: The definition for this parameter is only effective under free –port communication mode, and definition for other parameters are the same as original)

| | | | | | |
|--------|-------------------------|---|---|-----|---|
| F05.00 | Protocol selection | 0:Modbus protocol 1:reserved 2:Profibus protocol(extension effective) 3:CanLink protocol(extension effective) 4:CANopen protocol(extension effective) 5:freedom protocol 1(can modify all function parameters of EN500/EN600) 6:freedom protocol 2 (can only modify part of function parameter of EN500/EN600) Remark: expansion card is needed if select protocol 2, 3, 4 | 1 | 0 | × |
| F05.01 | Baud rate configuration | Units digit: freedom protocol and Modbus baud rate selection 0:300BPS 1:600BPS 2:1200BPS 3:2400BPS 4:4800BPS 5:9600BPS 6:19200BPS 7:38400BPS 8:57600BPS | 1 | 005 | × |
| F05.02 | Data format | Units digit: freedom protocol and Modbus protocol data format 0:1-8-1 format, no checkout, RTU 1:1-8-1 format, even checkout, RTU 2:1-8-1 format, odd checkout, RTU 3:1-7-1 format, no checkout, ASCII 4:1-7-1 format, even checkout, ASCII 5:1-7-1 format, odd checkout, ASCII | | 00 | × |
| F05.03 | Local address | 0~247, 00 is master station address | 1 | 1 | × |

B.2.4 Data command frame format

| Main device command frame format | | | | | | | | | | | | | | | | | | |
|----------------------------------|------------|--------------------------|--------------------------|---------------------|---------------------|-----------------|-----------------|-------------------|---------------|----------|----------|---------------|----------|--------------|--------------|--------------|--------------|-----------|
| Sending order | 1 | 2 | 3 | 4 | 5 | 6 | 7 | 8 | 9 | 10 | 11 | 12 | 13 | 14 | 15 | 16 | 17 | 18 |
| | frame head | auxiliary device address | auxiliary device address | main device command | main device command | assistant index | assistant index | command index | command index | set data | set data | set data | set data | checksum sum | checksum sum | checksum sum | checksum sum | frame end |
| Definition | head | address | | command area | | Index area | | Setting data area | | | | checksum area | | | | end | | |
| Sending byte | 1 | 2 | | 2 | | 4 | | 4 | | | | 4 | | | | 1 | | |

| Auxiliary device response frame format | | | | | | | | | | | | | | | | | | |
|--|------------|--------------------------|--------------------------|---------------------------|---------------------------|---------------|---------------|---------------|---------------|----------|----------|---------------|----------|--------------|--------------|--------------|--------------|-----------|
| Sending order | 1 | 2 | 3 | 4 | 5 | 6 | 7 | 8 | 9 | 10 | 11 | 12 | 13 | 14 | 15 | 16 | 17 | 18 |
| | frame head | auxiliary device address | auxiliary device address | auxiliary device response | auxiliary device response | failure index | failure index | command index | command index | run data | run data | run data | run data | checksum sum | checksum sum | checksum sum | checksum sum | frame end |
| Definition | head | address | | response area | | Index area | | Run data area | | | | Checksum area | | | | end | | |
| Sending byte | 1 | 2 | | 2 | | 4 | | 4 | | | | 4 | | | | 1 | | |

Fig.B-2 command/response frame format

Remark:

(1) “Setting data area” and “run data area” may not be existent in some command/data frame format, so in protocol command list it’s marked with “nothing”.

(2) In protocol effective character set is: ~, 1, 2, 3, 4, 5, 6, 7, 8, 9, A, B, C, D, E, F and hex data 0DH, ASCII lowercase a, b, c, d, e, f are invalid.

(3) Effective command frame length is 14 or 18 byte.

B.2.5 Explanation and description for format

(1) Frame head

It’s character“~” (namely hex 7E), single byte.

(2) Auxiliary device address

Data meanings: local address of auxiliary device, double byte. ASCII format.

Inverter factory default is 01.

(3) Mainframe command/auxiliary device respond

Data meanings: mainframe send out command and auxiliary device respond to the command. Double byte, ASCII format.

Response code function classification:

Species 1>: command code=“10”, mainframe ask auxiliary device to report current preparation state and control situation.

Table B-1 Command code meanings for response frame response area

| Response code ASCII | Meanings | | |
|------------------------|--|--------------------------------------|--------------------------------|
| | Preparation state of auxiliary device | Control from mainframe is allowed | To set frequency is allowed |
| 10 | Haven't get ready | No meaning | |
| 11 | Get ready | Allow | Allow |
| 12 | Get ready | Allow | Allow |
| 13 | Get ready | Don't allow | Don't allow |
| 14 | Get ready | Don't allow | Don't allow |
| 20 | Frame error | | |

Species 2>: command code=“11”~“15”, 5 kinds of function command which mainframe send to auxiliary device, for detail please see protocol command list.

Table B-2 Response code meanings for response frame command index area

| Response code ASCII | Meanings of response code | Description |
|------------------------|---|--|
| 00 | Auxiliary device communication and control is normal ; function code modification is effective; password is correct. | |
| 20 | (1) frame checkout error; (2)"command area" data overrun; (3)"index area" data overrun; (4)frame length error/non ASCII byte exist in area except frame head, frame end. | When this response code is reported, data of "command area", "index area" and "running data area" are not reported. |
| 30 | (1) control to auxiliary device is ineffective; (2) ineffective function code parameter modification; (3)"setting/running data" area data overrun. (4) password error. | Whether report this response code relate to current set state of auxiliary device. When report data of area", "index area" and "run data area" are reported according to protocol requirement. |

(4) Auxiliary index/command index/failure index

Data meanings: include auxiliary index byte and command index byte.

For mainframe, auxiliary index, command index are used for cooperating mainframe command in realizing specific function.

For auxiliary device, auxiliary index, command index are used for reporting failure state code, command index are reported without modification

Data type: hex, 4 byte, ASCII format.

Command index occupy 2 low byte, data range: "00"~"FF".

Auxiliary index occupy 2 high byte, data range: "00"~"FF".

Auxiliary device failure state occupy "auxiliary index" byte, see table B-3.

Table B-3 Free-port1 failure type description

| Failure code(decimal) | Description | Failure code(decimal) | Description |
|-----------------------|---|-----------------------|-----------------------------------|
| 1 | Overcurrent during accelerating process | 19 | Current detecting circuit failure |
| 2 | Overcurrent during decelerating process | 20 | External interference failure |
| 3 | Overcurrent during constant speed process | 21 | Internal interference failure |
| 4 | Overvoltage during accelerating process | 22 | PID provision loss |
| 5 | Overvoltage during decelerating process | 23 | PID feedback loss |
| 6 | Overvoltage during constant speed process | 24 | PID error amount exception |

| | | | |
|----|--|----|--|
| 7 | Overvoltage while halting | 25 | Startup terminal protection |
| 8 | Under voltage during running process | 26 | RS485 communication failure |
| 9 | Inverter overload protection | 27 | Reserved |
| 10 | Motor overload protection | 28 | Reserved |
| 11 | Motor underload protection | 29 | Reserved |
| 12 | Input phase missing | 30 | E ² PROM read and write wrongly |
| 13 | Output phase missing | 31 | Temperature detection breakage |
| 14 | Inverting module protection | 32 | Self-tuning failure |
| 15 | Short circuit to earth during running process | 33 | Contactors exception |
| 16 | Short circuit to earth during electrifying process | 34 | Interior failure 1 |
| 17 | Inverter over heating | | |
| 18 | External device failure | | |

Free-port 2 failure type description

| Failure code(decimal) | Description | Failure code(decimal) | Description |
|-----------------------|---|-----------------------|-----------------------------------|
| 1 | Overcurrent during accelerating process | 13 | Inverting module protection |
| 2 | Overcurrent during decelerating process | 14 | External device failure |
| 3 | Overcurrent during constant speed process | 15 | Current detecting circuit failure |
| 4 | Overvoltage during accelerating process | 16 | RS485 communication failure |
| 5 | Overvoltage during decelerating process | 17 | Reserved |
| 6 | Overvoltage during constant speed process | 18 | Reserved |
| 7 | Control power supply overvoltage | 19 | Under voltage |
| 8 | Inverter overload | 20 | System interference |
| 9 | Motor overload | 21 | Reserved |
| 10 | Inverter over heating | 22 | Reserved |

| | | | |
|----|----------|----|--|
| 11 | Reserved | 23 | E ² PROM read and write wrongly |
| 12 | Reserved | | |

(5) Checkout sum

Data meanings: frame checkout, 4 byte, ASCII.

Calculation method: accumulative sum of ASCII code value of all byte from “auxiliary device address” to “run data”.

(6) Frame end

Hex 0D, single byte.

B.2.6 Protocol command list

Frame 7E and frame end 0D, address, checkout sum, ASCII character format are omitted in following description.

Table B-4 Free-port 1 protocol command table

| Name | Mainframe order Decimal | Auxiliary index Hex | Order index Hex | Run data setting range Hex | Mainframe sending example, such as PC control operation of inverter (C language cluster format, auxiliary device is set to 01) | Run data precision | Description | |
|-----------------------------------|------------------------------------|------------------------|--------------------|-------------------------------|--|--------------------|-------------|--|
| Look up auxiliary motor state | 10 | 00 | 00 | no | ~010A00000192 r | 1 | | |
| Read parameter of auxiliary motor | Main setting frequency | 11 | 00 | 00 | no | ~010B00000193 r | 0.01Hz | |
| | Auxiliary setting frequency | 11 | 00 | 01 | no | ~010B00010194 r | 0.01Hz | |
| | Setting frequency | 11 | 00 | 02 | no | ~010B00020195 r | 0.01Hz | |
| | Output frequency | 11 | 00 | 03 | no | ~010B00030196 r | 0.01Hz | |
| | Output current | 11 | 00 | 04 | no | ~010B00040197 r | 0.1A | |
| | Output voltage | 11 | 00 | 05 | no | ~010B00050198 r | 1V | |
| | DC bus-bar voltage | 11 | 00 | 06 | no | ~010B00060199 r | 0.1V | |
| | Load motor revolving speed | 11 | 00 | 07 | no | ~010B0007019A r | 1RPM | |
| | Load motor linear speed | 11 | 00 | 08 | no | ~010B0008019B r | no | |
| | Inverter temperature | 11 | 00 | 09 | no | ~010B0009019C r | 1℃ | |
| | Runtime | 11 | 00 | 0A | no | ~010B000A01A4 r | 0.1min | |
| | Current accumulative runtime | 11 | 00 | 0B | no | ~010B000B01A5 r | 1h | |
| | Current accumulative power-on time | 11 | 00 | 0C | no | ~010B000C01A6 r | 1h | |
| | Inverter state | 11 | 00 | 0D | no | ~010B000D01A7 r | no | |
| Input terminal state | 11 | 00 | 0E | no | ~010B000E01A8 r | no | | |

| | | | | | | | |
|--|----|----|----|----|------------------|----------|--|
| Output terminal state | 11 | 00 | 0F | no | ~010B000F01A9\ r | no | |
| Expand output terminal state | 11 | 00 | 10 | no | ~010B00100194\ r | no | |
| Expanding input terminal state | 11 | 00 | 11 | no | ~010B00110195\ r | no | |
| Communicational virtual input terminal state | 11 | 00 | 12 | no | ~010B00120196\ r | no | |
| Internal virtual input node state | 11 | 00 | 13 | no | ~010B00130197\ r | no | |
| Analog input AI1 | 11 | 00 | 14 | no | ~010B00140198\ r | no | |
| Analog input AI2 | 11 | 00 | 15 | no | ~010B00150199\ r | no | |
| Expanding analog input EAI1 | 11 | 00 | 16 | no | ~010B0016019A\ r | no | |
| Expanding analog input EAI2 | 11 | 00 | 17 | no | ~010B0017019B\ r | no | |
| Analog AO1 output | 11 | 00 | 18 | no | ~010B0018019C\ r | no | |
| Analog AO2 output | 11 | 00 | 19 | no | ~010B0019019D\ r | no | |
| Expanding analog EAO1 output | 11 | 00 | 1A | no | ~010B001A01A5\ r | no | |
| Expanding analog EAO2 output | 11 | 00 | 1B | no | ~010B001B01A6\ r | no | |
| External pulse input frequency | 11 | 00 | 1C | no | ~010B001C01A7\ r | 1Hz | |
| Reserved | | | | | | | |
| Process PID provision | 11 | 00 | 1E | no | ~010B001E01A9\ r | 0.01V | |
| Process PID feedback | 11 | 00 | 1F | no | ~010B001F02AA\ r | 0.01V | |
| Process PID error | 11 | 00 | 20 | no | ~010B00200195\ r | 0.01V | |
| Process PID output | 11 | 00 | 21 | no | ~010B00210196\ r | 0.01Hz | |
| Simple PLC current segments | 11 | 00 | 22 | no | ~010B00220197\ r | no | |
| External multi-section speed current segments | 11 | 00 | 23 | no | ~010B00230198\ r | no | |
| Provision pressure for constant pressure water | 11 | 00 | 24 | no | ~010B00240199\ r | 0.001Mpa | |
| Feedback pressure for constant pressure water | 11 | 00 | 25 | no | ~010B0025019A\ r | 0.001Mpa | |
| Relay state for constant pressure water | 11 | 00 | 26 | no | ~010B0026019B\ r | no | |
| Current length | 11 | 00 | 27 | no | ~010B0027019C\ r | no | |
| Accumulative length | 11 | 00 | 28 | no | ~010B0028019D\ r | no | |
| Current internal count | 11 | 00 | 29 | no | ~010B0029019E\ r | no | |
| Current internal time | 11 | 00 | 2A | no | ~010B002A01A6\ r | no | |
| Setting channel for run command | 11 | 00 | 2B | no | ~010B002B01A7\ r | no | |
| Main frequency provision channel | 11 | 00 | 2C | no | ~010B002C01A8\ r | no | |
| Auxiliary frequency provision channel | 11 | 00 | 2D | no | ~010B002D01A9\ r | no | |
| Inverter rated current | 11 | 00 | 2E | no | ~010B002E01AA\ r | 0.1A | |
| Inverter rated voltage | 11 | 00 | 2F | no | ~010B002F01AB\ r | 1V | |
| Inverter rated power | 11 | 00 | 30 | no | ~010B00300196\ r | 0.1KW | |

| | | | | | | | | |
|------------------------------------|---|----|----|----|----------------------|---------------------|--------|---|
| | Reserved | | | | | | | |
| | Reserved | | | | | | | |
| | Frequency after acceleration and deceleration | 11 | 00 | 33 | no | ~010B00330199)r | 0.01Hz | |
| | Motor rotor frequency | 11 | 00 | 34 | no | ~010B0034019A)r | 0.01Hz | |
| | Current provision torque | 11 | 00 | 35 | no | ~010B0035019B)r | 0.1% | |
| | Current output torque | 11 | 00 | 36 | no | ~010B0036019C)r | 0.1% | |
| | Current torque current | 11 | 00 | 37 | no | ~010B0037019D)r | 0.1A | |
| | Current flux current | 11 | 00 | 38 | no | ~010B0038019E)r | 0.1A | |
| Run control and adjusting function | Auxiliary device run command | 12 | 00 | 00 | no | ~010C00000194)r | no | |
| | Set current run frequency provision of auxiliary device | 12 | 00 | 01 | 0Hz~high limit freq | ~010C00010FA0027C)r | 0.01Hz | Set freq. =40.00Hz |
| | Auxiliary device run with run frequency provision | 12 | 00 | 02 | 0Hz~high limit freq | ~010C00020FA0027D)r | 0.01Hz | Auxiliary device run Set freq. =40.00Hz |
| | Auxiliary device forward run | 12 | 00 | 03 | no | ~010C00030197)r | no | |
| | Auxiliary device reverse run | 12 | 00 | 04 | no | ~010C00040198)r | no | |
| | Auxiliary device forward run with run frequency provision | 12 | 00 | 05 | 0Hz~ high limit freq | ~010C00050FA00280)r | 0.01Hz | Forward run boot-strap Set freq. =40.00Hz |
| | Auxiliary device reverse run with run frequency provision | 12 | 00 | 06 | 0Hz~ high limit freq | ~010C00060FA00281)r | 0.01Hz | Reverse run boot-strap Set freq. =40.00Hz |
| | Auxiliary device stop | 12 | 00 | 07 | no | ~010C0007019B)r | no | |
| | Auxiliary device jog run | 12 | 00 | 08 | no | ~010C0008019C)r | no | |
| | Auxiliary device forward jog run | 12 | 00 | 09 | no | ~010C0009019D)r | no | |
| | Auxiliary device reverse jog run | 12 | 00 | 0A | no | ~010C000A01A5)r | no | |
| | Auxiliary device stop run | 12 | 00 | 0B | no | ~010C000B01A6)r | no | |
| | Auxiliary device failure restoration | 12 | 00 | 0C | no | ~010C000C01A7)r | no | |
| Software version query order | Query auxiliary device software version | 15 | 00 | 00 | no | ~010F00000197)r | 1 | |

Free-Port 2 protocol command table

| Name | Mainframe order decimal | Auxiliary index hex | Order index Hex | Run data setting range hex | Mainframe sending example, such as PC control operation of inverter (C language cluster format , auxiliary device is set to 01) | Run data precision | Description |
|------------------------------------|---|---------------------|-----------------|----------------------------|---|---------------------|-------------|
| look up auxiliary motor state | 10 | 00 | 00 | no | ~010A00000192\r | 1 | |
| Run control and adjusting function | Auxiliary device run command | 12 | 00 | 00 | no | ~010C00000194\r | no |
| | Set current run freq. of auxiliary device | 12 | 00 | 01 | 0Hz~high limit freq | ~010C00010FA0027C\r | 0.01Hz |
| | Auxiliary device run with run frequency provision | 12 | 00 | 02 | 0Hz~high limit freq | ~010C00020FA0027D\r | 0.01Hz |
| | Auxiliary device forward run | 12 | 00 | 03 | no | ~010C00030197\r | no |
| | Auxiliary device reverse run | 12 | 00 | 04 | no | ~010C00040198\r | no |
| | Auxiliary device forward run with run frequency provision | 12 | 00 | 05 | 0Hz~high limit freq | ~010C00050FA00280\r | 0.01Hz |
| | Auxiliary device reverse run with run frequency provision | 12 | 00 | 06 | 0Hz~high limit freq | ~010C00060FA00281\r | 0.01Hz |
| | Auxiliary device stop | 12 | 00 | 07 | no | ~010C0007019B\r | no |
| | Auxiliary device jog run | 12 | 00 | 08 | no | ~010C0008019C\r | no |
| | Auxiliary device forward jog run | 12 | 00 | 09 | no | ~010C0009019D\r | no |
| | Auxiliary device reverse jog run | 12 | 00 | 0A | no | ~010C000A01A5\r | no |
| | Auxiliary device stop run | 12 | 00 | 0B | no | ~010C000B01A6\r | no |
| | Auxiliary device failure restoration | 12 | 00 | 0C | no | ~010C000C01A7\r | no |
| Software version query order | 15 | 00 | 00 | no | ~010F00000197\r | 1 | |

Table B-5 read auxiliary device function code parameter

| | | | | | | | |
|--------------------------|--|---------|-------|------------------------|-------------------------|--------------|-----------|
| Function definition | Read auxiliary device function code parameter: all function code parameter except user password and manufacturer password except user password and manufacturer password | | | | | | |
| Meanings | Frame head | Address | Order | Order index | Run data | Checkout sum | Frame end |
| Mainframe order | 7EH | ADDR | 13 | See remark | 4 | BCC | 0DH |
| Byte quantity | 1 | 2 | 2 | 4 | 0 | 4 | 1 |
| Auxiliary device respond | 7EH | ADDR | 06 | See remark | Function code parameter | BCC | 0DH |
| Byte quantity | 1 | 2 | 2 | 4 | 4 | 4 | 1 |
| remark | Command index=combination of function code group number and hex code of function code number. For instance: If want to read parameter of F0.05 function code, order index=0005; If want to read parameter of F2.11 function code, order index =020B; If want to read parameter of F2.15 function code, order index =020F; If want to read parameter of F2.13 function code, order index =020D; | | | | | | |
| | Corresponding relation between decimal and hex value of function code group No. | | | | | | |
| | Function code group No | Decimal | Hex | Function code group No | Decimal | Hex | |
| | F00 | 0 | 00H | F0E | 14 | 0EH | |
| | F01 | 1 | 01H | F0F | 15 | 0FH | |
| | F02 | 2 | 02H | F10 | 16 | 10H | |
| | F03 | 3 | 03H | F11 | 17 | 11H | |
| | F04 | 4 | 04H | F12 | 18 | 12H | |
| | F05 | 5 | 05H | F13 | 19 | 13H | |
| | F06 | 6 | 06H | F14 | 20 | 14H | |
| | F07 | 7 | 07H | F15 | 21 | 15H | |
| | F08 | 8 | 08H | F16 | 22 | 16H | |
| | F09 | 9 | 09H | F17 | 23 | 17H | |
| | F0A | 10 | 0AH | F18 | 24 | 18H | |
| | F0B | 11 | 0BH | F19 | 25 | 19H | |
| | F0C | 12 | 0CH | F1A | 26 | 1AH | |
| F0D | 13 | 0DH | F1B | 27 | 1BH | | |
| Virtual data | 0~FFFF (namely 0~65535) | | | | | | |

Please input correct “user password” before you set user function code parameter.

Table B-6 set auxiliary device function code parameter

| | | | | | | | |
|--------------------------|--|---------|-------|------------------------|-------------------------|--------------|-----------|
| Function definition | Set auxiliary device function code parameter: all function code parameter except user password and manufacturer password | | | | | | |
| Meanings | Frame head | Address | Order | Order index | Run data | Checkout sum | Frame end |
| Mainframe order | 7EH | ADDR | 14 | See remark | 4 | BCC | 0DH |
| Byte quantity | 1 | 2 | 2 | 4 | 4 | 4 | 1 |
| Auxiliary device respond | 7EH | ADDR | 06 | See remark | Function code parameter | BCC | 0DH |
| Byte quantity | 1 | 2 | 2 | 4 | 4 | 4 | 1 |
| Remark | Command index=combination of function code group number and hex code of function code number. For instance: If want to read parameter of F00.05 function code, order index=0005; If want to read parameter of F02.11 function code, order index =020B; If want to read parameter of F02.15 function code, order index =020F; If want to read parameter of F02.13 function code, order index =020D; | | | | | | |
| | Corresponding relation between decimal and hex value of function code group No. | | | | | | |
| | Function code group No | Decimal | Hex | Function code group No | Decimal | Hex | |
| | F00 | 0 | 00H | F0E | 14 | 0EH | |
| | F01 | 1 | 01H | F0F | 15 | 0FH | |
| | F02 | 2 | 02H | F10 | 16 | 10H | |
| | F03 | 3 | 03H | F11 | 17 | 11H | |
| | F04 | 4 | 04H | F12 | 18 | 12H | |
| | F05 | 5 | 05H | F13 | 19 | 13H | |
| | F06 | 6 | 06H | F14 | 20 | 14H | |
| | F07 | 7 | 07H | F15 | 21 | 15H | |
| | F08 | 8 | 08H | F16 | 22 | 16H | |
| | F09 | 9 | 09H | F17 | 23 | 17H | |
| | F0A | 10 | 0AH | F18 | 24 | 18H | |
| F0B | 11 | 0BH | F19 | 25 | 19H | | |
| F0C | 12 | 0CH | F1A | 26 | 1AH | | |
| F0D | 13 | 0DH | F1B | 27 | 1BH | | |
| Virtual data | 0~FFFF(namely 0~65535) | | | | | | |

Appendix C Keyboard

C.1 Keyboard selection:

| NO. | Type | Details | Remark |
|-----|-----------|---|----------|
| 1 | EN-LED3-D | Local LED single-display digital potentiometer keyboard (with the function of parameter copy) | Standard |
| 2 | EN-LED4-D | Local LED double-display digital potentiometer keyboard (with the function of parameter copy) | Optional |
| 3 | EN-LCD1 | Local LCD Keyboard (with the function of parameter copy) | Optional |
| 4 | EN-LCD2 | Remote Control LCD Keyboard (with the function of parameter copy) | Optional |
| 5 | EN-LED1 | Local LED single-display keyboard | Optional |

At present, Our has 4 kinds of optional keyboards for our customers' selection, they are EN-LED4-D, EN-LCD1, EN-LCD2 and EN-LED1. Their outer dimension and installation size are the same as the standard keyboard EN-LED3-D. For more detailed dimension, please refer to "Keyboard Operation and Outer Size of Keyboard installing box" in Chapter 2.



Note

1. EN-LED3-D, EN-LED4-D, EN-LCD1, EN-LCD2 are four kinds of keyboard that with the function of parameter copy.
2. Using the function of parameter copy could through operating parameter F00.27

C.2 LED double-display digital potentiometer keyboard

Local LED double-display digital potentiometer keyboard type: EN-LED4-D

C.2.1 Keyboard Layout

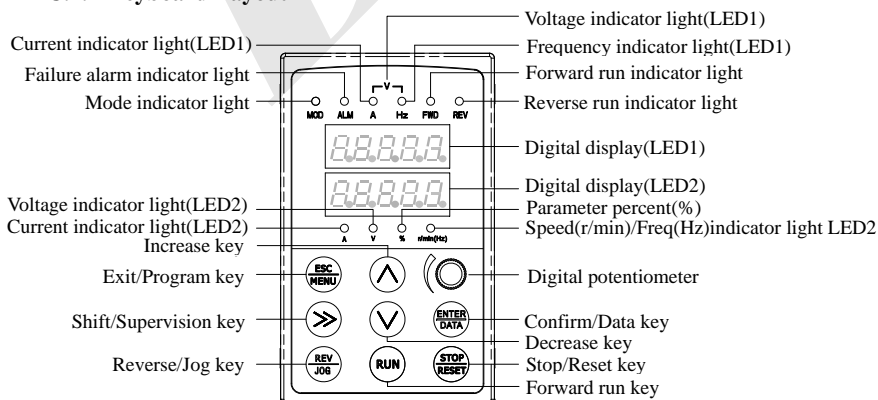

Fig.C-1 EN-LED4-D Operating Keyboard Layout

C.2.2 Description for keyboard functions, LED digital tubes and indicator lights

LED double -display digital potentiometer keyboard consists of two 5-digit digital tube screens, 8 buttons, a digital potentiometer and 10 indicator lights.

If need more details about function definition of the 8 buttons, LED digital tubes, digital potentiometer and specification of the indicator lights, then please refer to “Keyboard Function Specifications” in Chapter 5.



Note

LED2 digital tube supervision is set by parameter F00.25.

C.3 LCD keyboard

C.3.1 LCD keyboard series:

- (1) Local LCD keyboard type: EN-LCD1
- (2) Remote control LCD keyboard type: EN-LCD2

C.3.2 Keyboard Layout

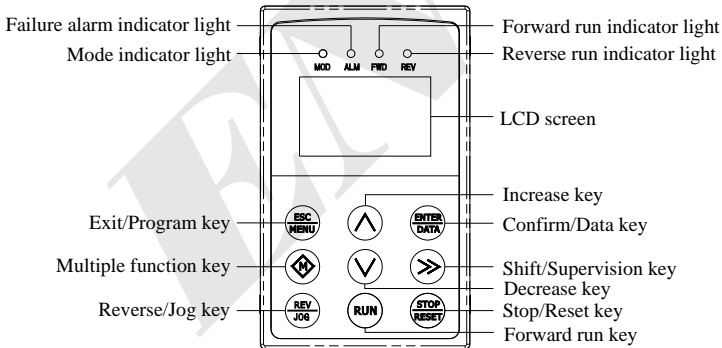

Fig.C-2 Keyboard Layout Sketch (EN-LCD1, EN-LCD2)

C.3.3 Keyboard Function, LCD Display and Spec. of Indicator Lights

LCD keyboard consists of a LCD screen, 9 buttons and 4 indicator lights

LCD screen: To display Function Setting, Running Supervision, Failure Supervision Code and Parameter.

Multi-function key: The specific function keys decided by tens digit of F00.15 see F00.15 parameter descriptions.

For more details about function definition of the 8 buttons and specification of the indicator lights, please refer to “Keyboard Function Specifications” in Chapter 5.

C.3.4 Operating Spec. of LCD Display Keyboard

(1) Initialization status of LCD keyboard when power on

When the keyboard is power on, “Key Board” is displayed in the form of animation:

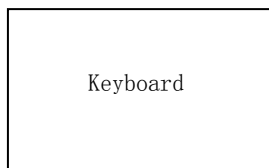

Fig.C-3 Initialization Display when Power On

(2) Operation of switching to firstly menu (Fig. C-4):

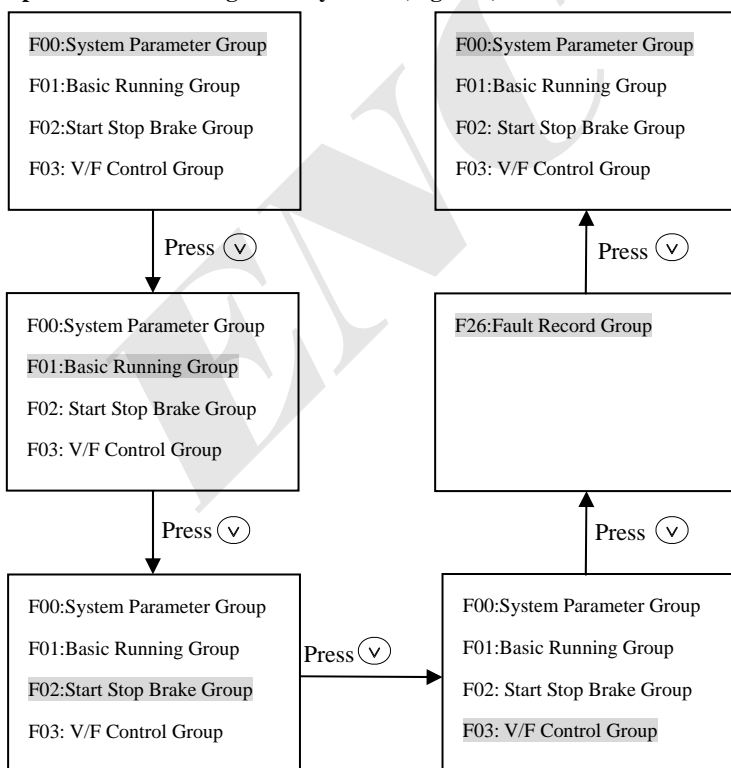

Fig.C-4 Power on initialized display

When set F00.00=2, Senior Menu parameters F00~F27 can be displayed, 28 groups in total. Operation methods are shown as Fig. C-4.

(3) Display and operation of secondary menu:

When you are in the Firstly Menu, choose a parameter group, then press “ENTER/DATA” key and you will enter into the Secondary Menu. Take Parameter F00.00 for example:

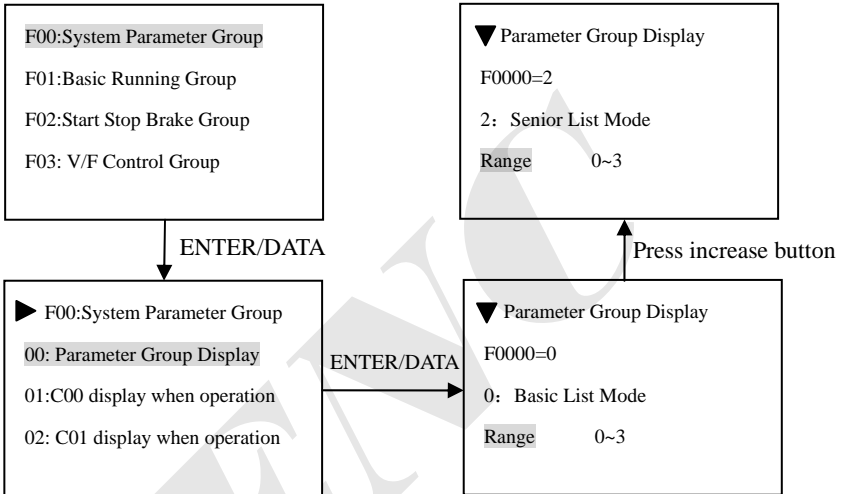

Fig.C-5 Example of Secondary Menu Operation

(4) Function Parameter Operation

Function parameter operation includes the parameter checking, revise and storage of parameters. Before the operating the inverter, parameters should be set correctly. Operation methods are shown as Fig. C-6:

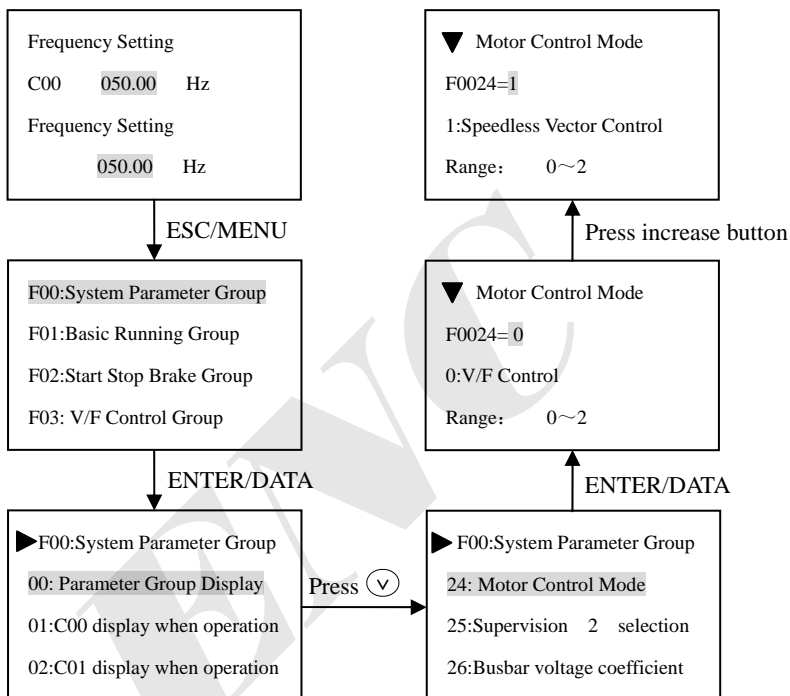

Fig.C-6 Example of function parameter editing

(5) Fault query status

When fault alarm occurs, customers can enter the fault query status:

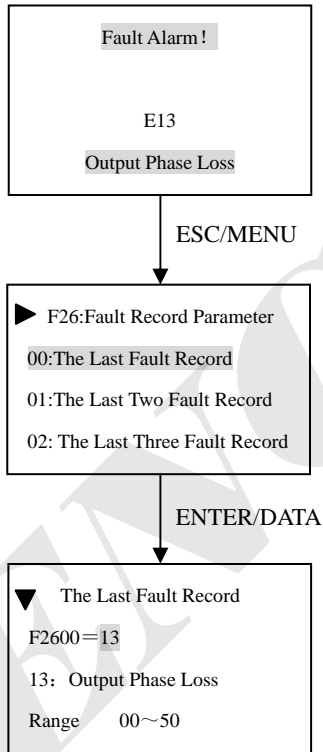

Fig.C-7 Fault query status

C.4 LED single-display keyboard

The type of local single-display keyboard: EN-LED1。

C.4.1 Keyboard Layout

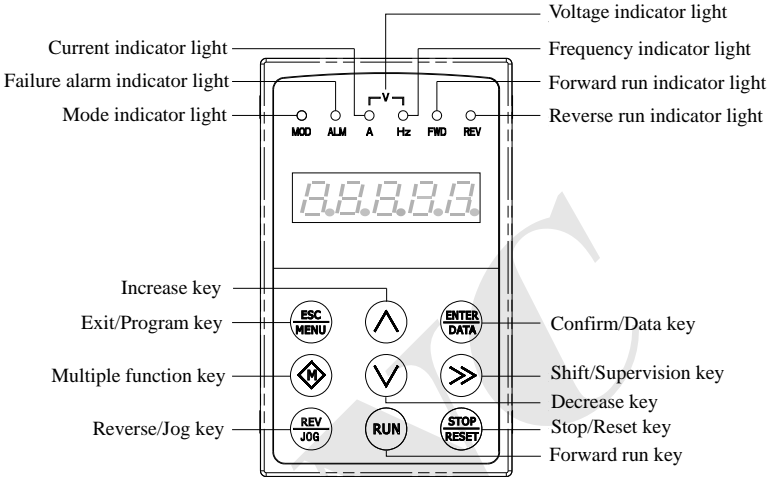

Fig.C-8 EN-LED1 Operation keyboard layout

C.4.2 Keyboard function, LED Nixie tube and indicator light description

LED single-display keyboard is composed of a 5-digit nixie tube display、9 keys and 6 indicator lights.



Multi-function key: The specific function keys decided by tens digit of F00.15 see F00.15 parameter descriptions.

For more details about function definition of the 8 buttons and specification of the indicator lights, please refer to “Keyboard Function Specifications” in Chapter 5.



Note

1.Key position of EN-LED1, EL-LCD1, EN-LCD2 is different from those standard keyboard, please note the key position of these three keyboards.

2.For EN-LED1, EN-LCD1, EN-LCD2 these keyboards, the deblocking way is different from the standard keyboards, the deblocking way is to press  or press  for more than 2 seconds.

C.5 Communication Component

The maximum electric distance between keyboard EN-LED3-D, EN-LED4-D, EN-LCD1, EN-LED1 and local inverter is 2m.

RS485 communication mode is adopted between inverter and remote keyboard EN-LCD2, only an ordinary cable is needed to connect each other, and their maximum electric distance can be 1000m. When the communication with each other is main-auxiliary mode, namely take remote keyboard as main device and inverter as auxiliary device. The terminals of the connection cable are made by crystal ends, so it is easy to maintain. Power needs customers' outer leading, the voltage range is from 10V to 24V, the demand current is 150mA, 1mm² of PVC insulate copper wire is suggested to connect.

Following function can be realized by remote keyboard:

- (1) Can control run, stop, jog, failure reset, change setting frequency, modify function parameter and run direction of auxiliary device.
- (2) Can identify the type of auxiliary device. Can monitor the running frequency, setting frequency, output voltage, output current, analog closed loop feedback, analog closed loop setting and exterior counting value of auxiliary device.

Appendix D Communication extension card

D.1 Communication card selection:

At the present, there are four kinds of communication card can be selected for.

| Serial No. | Type | Description | Remark |
|------------|---------|---|----------|
| 1 | EN-PR01 | PROFIBUS-DP communication card (use in 15KW and the below) | Optional |
| 2 | EN-PR02 | PROFIBUS-DP communication card (use in 15KW the above) | Optional |
| 3 | EN-CAN1 | CANopen communication card | Optional |
| 4 | EN-CAN2 | CANlink communication card | Optional |

D.2 PROFIBUS-DP communication card

D.2.1 PROFIBUS introduction

(1)PROFIBUS (short for Process Field Bus),PROFIBUS is an international and open field bus standard independent with manufacturer. It can be support for many equipment manufacturers, with good compatibility. It's widely used in Manufacturing Automation, automation of process industry, and other buildings, transportation, electric power automation field.

(2)PROFIBUS can realize exchanging the data between all kinds of element of automation, all of this equipment can exchange the information though the same port. But the transmission rate is different .all the automatic equipment can exchange the information though the same port, but with the different rates, so PROFIBUS should offer different types for the speed rates selection. it is made up with PROFIBUS-DP(Distributed peripheral),

PROFIBUS-PA,PROFIBUS-FMS.

(3)PROFIBUS (RS485), the first layer realize the balanced data transmission, wire a bus segment one Bus segment is shielded twisted pair cable, both ends of the segments have a terminating resistor. Transmission mode to half duplex, asynchronous, synchronous gap-free data exchange basis, the physical layer supports fibre, the data frame 11, and the transfer rate: 9.6Kbit / sec-12Mbit / sec. Bus length range from 100 to 1200 meters

(4)Between same-level controller and PC communications (token passing procedure), to ensure adequate opportunity to deal with their communication tasks in a determined time. Complex PLC and PC with a simple division formula I / O communications, you must quickly and with minimal protocol overhead (master - slave program)

D.2.2 The external form of PROFIBUS-DP and terminal definition description

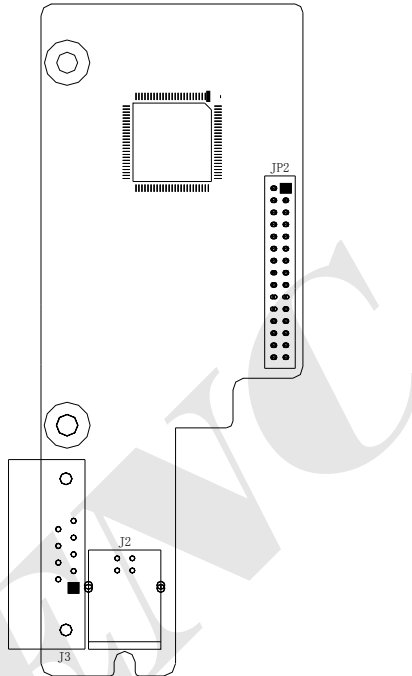
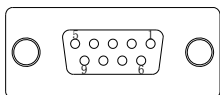

Fig D-1 PROFIBUS-DP outline dimensional drawing

Table D-1 Terminal function description

| Terminal date | Name | Description | Remark |
|---------------|-------------------------------|--|--|
| J2 | USB form adapter plugs | USB connection factory and distribution to DB9 adapter cable | Use it on 15KW frequency inverter or below |
| J3 | DB9 communication port | communication signal connection interface,9-pin DB9 female. | Use it on 15KW frequency inverter or the above |
| JP2 | Board-level docking connector | When you install this plug docking with the main control board CN2 | |

(1) J3 Plug pin definition :



| PIN data | Definition | PIN data | Definition |
|----------|------------------------|----------|------------------------|
| 1 | bit bare | 6 | VCC |
| 2 | bit bare | 7 | bit bare |
| 3 | Communication signal A | 8 | communication signal B |
| 4 | bit bare | 9 | bit bare |
| 5 | GND | - | - |

(2) J2 Plug pin definition :

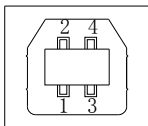

| PIN data | Definition | PIN data | Definition |
|----------|------------------------|----------|------------|
| 1 | Communication signal A | 3 | GND |
| 2 | Communication signal B | 4 | VCC |

(3) J2 switch wiring

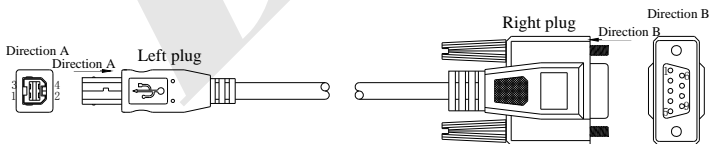

Table D-2 The left end plug and The right end plug PIN data

| The left end plug PIN data | The right end plug PIN data | The left end plug PIN data | The right end plug PIN data |
|----------------------------|-----------------------------|----------------------------|-----------------------------|
| - | 1 | 4 | 6 |
| - | 2 | - | 7 |
| 1 | 3 | 2 | 8 |
| - | 4 | - | 9 |
| 3 | 5 | - | - |

D.3 CANopen communication card

D.3.1 CANopen introduction

CANopen is an architecture in the control area network (Controller Area Network, CAN) on the high-level communication agreements, including communication equipment sub-sub-agreements and agreements, often used in embedded systems, industrial control is a commonly used fieldbus. CANopen implements the network layer and above the agreement OSI model. CANopen standard includes addressing scheme, several small communication sub-agreements

D.3.2 Equipment model

Communication agreement on other modules communication processing and network communication unit needed to start and reset the device has a state machine control. State machine include: Initialization, Pre-operational, Operational, Stopped.

D.3.3 Object Dictionary

Object Dictionary (OD: Object Dictionary) is an ordered group of objects; each object using an index value of 16 is addressed, in order to allow access to the data structure of a single element, while the definition of an eight sub-indexes.

D.3.4 Communication

- (1)Communication objects: Management packets, Service Data Objects (SDO), process data objects (PDO), the pre-definition packet or special function object
- (2)Communication model: master/slave model, client/server model, producer/consumer model

D.3.5 Agreement

- (1) NMT Agreement (network management, network management): Status Agreement definition of the state machine change commands (such as starting or stopping the equipment), to detect remote device bootup and failure scenarios.
- (2) Heartbeat Agreement: nodes in the network to monitor and confirm it is working properly.
- (3) SDO agreement: between devices used to transfer large low-priority data, typically used to configure devices on the CANopen network.
- (4) PDO Agreement: 8 bytes or less used to transmit data, no other agreement preset (which means data has been pre-definition).

D.3.6 CANopen form and terminal definition description

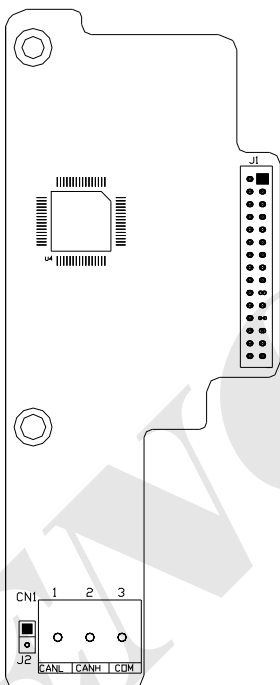

Fig D-2 CANopen outline dimensional drawing

Table D-3 Terminal function description

| Terminal number | Name | Description | Remark |
|-----------------|--------------------------------|--|--------|
| CN1 | Communication wiring terminal | By the client device connected to the CAN bus communication | |
| J1 | Signal port | When you install this plug docking with the main control board CN2 | |
| J2 | Terminal resistor access entry | Connect J2, then terminal resistor connect to bus | |

(1)CN1 pin definition

| PIN data | Definition | PIN data | Definition |
|----------|-------------|----------|------------|
| 1 | signal CANL | 3 | COM |
| 2 | signal CANH | - | - |

D.4 CANlink communication card

D.4.1 CANlink introduction

The physical layer CANlink card is CAN bus, only supports CAN2.0B extended frame. Since the control signal CANlink card connected directly to the main board, compared with CANOPEN card, with high transmission efficiency, real-time, stability and other characteristics, the maximum transfer rate of 1Mbps. CAN bus data transmission using a differential signal, with strong anti-interference, transmission distance and other characteristics, the communication rate 5Kbps below, the farthest reach 10Km, at 1Mbps baud rate up to 30m.

CANlink protocol is self-definition protocols, support for modifications and inverter terminal parameters monitoring.

D.4.2 CANlink card figure and terminal definition description

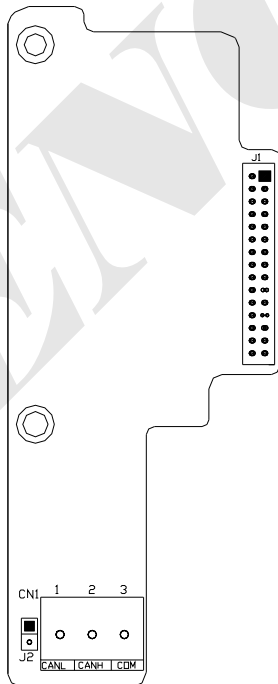

Fig D-3 CANlink Dimensions

Table D-4 Terminal function description

| Terminal Number | Name | Description | Remark |
|-----------------|--------------------------------|--|--------|
| CN1 | Communication wiring terminal | By the client device connected to the CAN bus communication | |
| J1 | Signal port | When you install this plug docking with the main control board CN2 | |
| J2 | Terminal resistor access entry | Connect J2, then terminal resistor connect to bus | |

(1) The definition of CN1 pin.

| PIN data | Definition | PIN data | Definition |
|----------|-------------|----------|------------|
| 1 | Signal CANL | 3 | COM |
| 2 | Signal CANH | - | - |

Appendix E Universal encoder expansion card

E.1 The selection of encoder expansion card:

Universal encoder expansion card (PG card), As an option to use, it is the necessary option for closed loop vector control inverter.

| No. | Model | Description | Remark |
|-----|---------|--|----------|
| 1 | EN-PG01 | Differentiator input PG card, encoder input signal not isolated (suitable for all series machine) | Optional |
| 2 | EN-PG02 | Differentiator input PG card, encoder input signal through the optocoupler isolation, stronger anti-interference ability (suitable for all series machine) | Optional |
| 3 | EN-PG03 | Oc input PG card, encoder input signal through the optocoupler isolation | Optional |

E.2 EN-PG01,EN-PG02 shape and terminal definitions

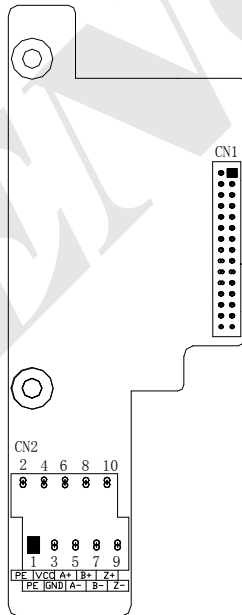

Fig.E-1 EN-PG01, EN-PG02 Outline dimension drawing

Table E-1 Terminal function description

| Terminal number | Name | Description | Remark |
|-----------------|-----------------------------|---|--------|
| CN1 | Board and board Butt socket | When installing the plug and the main control board CN2 docking | |
| CN2 | The user interface | The encoder uses | |

(1) CN2 Terminal definitions

| PIN data | Terminal labeling | Description |
|----------|-------------------|--|
| 1 | PE | Shielding terminal |
| 2 | PE | Shielding terminal |
| 3 | GND | Power supply (GND of EN-PG01 and GND of control panel is connect. GND of EN-PG02 and GND of control panel isolation) |
| 4 | VCC | Provide 5V/300mA current toward outside |
| 5 | A- | Encoder output signal A negative |
| 6 | A+ | Encoder output signal A positive |
| 7 | B- | Encoder output signal B negative |
| 8 | B+ | Encoder output signal B positive |
| 9 | Z- | Encoder output signal Z negative |
| 10 | Z+ | Encoder output signal Z positive |

(2) PG card specification:

| | |
|---------------------------------------|----------------|
| The user interface | Terminal table |
| Spacing | 3.81mm |
| The maximum rate | 500kHz |
| Differentiator input signal amplitude | ≤7V |

E.3 EN-PG03 shape and terminal definitions

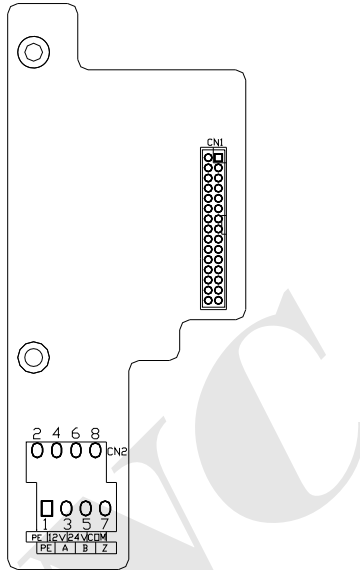

Fig.E-2 EN-PG03 Outline dimension drawing

Table E-2 Terminal function description

| Terminal number | Name | Description | Remark |
|-----------------|-----------------------------|---|--------|
| CN1 | Board and board Butt socket | When installing the plug and the main control board CN2 docking | |
| CN2 | The user interface | The encoder uses | |

(1) CN2 Terminal definitions

| PIN data | Terminal labeling | Description |
|----------|-------------------|--|
| 1 | PE | Shielding terminal |
| 2 | PE | Shielding terminal |
| 3 | A | Encoder output signal A |
| 4 | 12V | Provide voltage of 12V externally(Only supply power for 12V encoder) |
| 5 | B | Encoder output signal B |
| 6 | 24V | Provide 24V/100mA current |
| 7 | Z | Encoder output signal Z |
| 8 | COM | Power ground |

Appendix F Integration expansion card

F.1 Expansion card model selection:

| No. | Model | Introductions | Note |
|-----|-----------|---|----------|
| 1 | EN-PRPG01 | PROFIBUS-DP and OC output PG integration expansion card (apply to 5.5KW Inverter and above power) | Optional |

F.2 EN-PRPG01 expansion card

F.2.1 PROFIBUS Info

Please refer to appendix D about the details of communication expansion card.

F.2.2 Outside view and terminal definition introduction

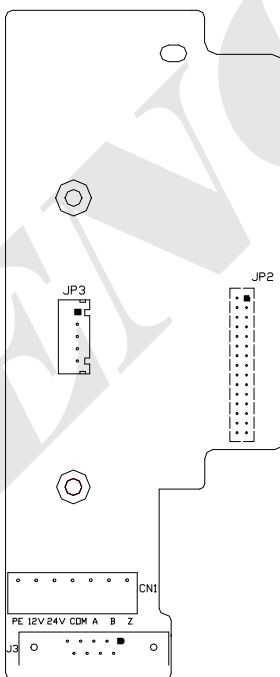
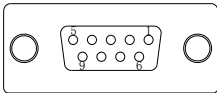

Fig. F-1 Outline drawing

Table F-1 Terminal function description

| No. | Name | Description |
|-----|----------------------------|---|
| J3 | DP9 D type joint | Communication signal connecting interface, 9-pin DP9 female |
| JP2 | Board level docking port | Connect this plug with CN2 on the control board |
| JP3 | Program download interface | Used by manufacturer |
| CN1 | User interface | To connect encoder |

(1) J3 plug pin definition:

| Pin No. | Definition | Pin No. | Definition |
|---------|------------------------|---------|------------------------|
| 1 | Vacancy | 6 | Power VCC |
| 2 | Vacancy | 7 | Vacancy |
| 3 | Communication signal A | 8 | Communication signal B |
| 4 | Vacancy | 9 | Vacancy |
| 5 | Power ground (GND) | - | - |

(2) CN1 terminal definition

| Pin No. | Terminal mark | Description |
|---------|---------------|---|
| 1 | PE | Shielding terminal |
| 2 | 12V | Provide 12V voltage (only supply for 12V encoder) |
| 3 | 24V | Provide 24V/100mA current |
| 4 | COM | Power ground (GND) |
| 5 | A | Encoder output A signal |
| 6 | B | Encoder output B signal |
| 7 | Z | Encoder output Z signal |

Appendix G Braking unit and braking resistance

G.1 Braking unit and braking resistance

The motor's electric potential energy will charge inverter's capacitance up reversely if speed of the motor descends too quickly or load of the motor wobbles too quickly while the inverter is running, which will increase the voltage upon power modules suddenly and is easy to make the inverter damaged. The inverter will control it according to load size and performance. You only need to connect external braking resistance to realize timely energy discharge when the braking function is needed. To connect external resistance is a kind of energy consumption braking mode, as all the energy is consumed by the braking resistance.

EN600-2S0037, EN600-4T0007G/0015P ~ EN600-4T0150G/0185P has been configured the built-in braking unit for EN600-2S0004 ~ EN600-2S0022, EN600-4T0185G/0220P ~ EN600-4T0550G/0750P, the built-in braking unit is optional.

When braking function needed, please connect external braking resistance according to below table.

Configuration table of braking unit and braking resistor configuration as well as circumscribed braking resistor

| Frequency inverter type | Built-in braking unit | Built-in braking resistor | Add braking resistor | Quantity | Power of braking resistor (50% braking rate) | Power of braking resistor (10% braking rate) |
|-------------------------|-----------------------|---------------------------|----------------------|----------|--|--|
| EN600-2S0004 | Optional | 无 | $\geq 150\Omega$ | 1PCS | $\geq 1KW$ | $\geq 200W$ |
| EN600-2S0007 | Optional | 无 | $\geq 100\Omega$ | 1PCS | $\geq 1.5KW$ | $\geq 250W$ |
| EN600-2S0015 | Optional | 无 | $\geq 70\Omega$ | 1PCS | $\geq 2KW$ | $\geq 400W$ |
| EN600-2S0022 | Optional | 无 | $\geq 50\Omega$ | 1PCS | $\geq 3KW$ | $\geq 600W$ |
| EN600-2S0037 | Built-in | 无 | $\geq 30\Omega$ | 1PCS | $\geq 5KW$ | $\geq 1KW$ |
| EN600-4T0007G/0015P | Built-in | No | $\geq 300\Omega$ | 1PCS | $\geq 1KW$ | $\geq 250W$ |
| EN600-4T0015G/0022P | Built-in | No | $\geq 300\Omega$ | 1PCS | $\geq 1KW$ | $\geq 250W$ |
| EN600-4T0022G/0037P | Built-in | No | $\geq 300\Omega$ | 1PCS | $\geq 1KW$ | $\geq 250W$ |
| EN600-4T0037G/0055P | Built-in | No | $\geq 125\Omega$ | 1PCS | $\geq 2KW$ | $\geq 400W$ |
| EN600-4T0055G/0075P | Built-in | No | $\geq 80\Omega$ | 1PCS | $\geq 3.8KW$ | $\geq 750W$ |
| EN600-4T0075G/0110P | Built-in | No | $\geq 80\Omega$ | 1PCS | $\geq 3.8KW$ | $\geq 750W$ |
| EN600-4T0110G/0150P | Built-in | No | $\geq 50\Omega$ | 1PCS | $\geq 5KW$ | $\geq 1KW$ |
| EN600-4T0150G/0185P | Built-in | No | $\geq 40\Omega$ | 1PCS | $\geq 7.5KW$ | $\geq 1.5KW$ |
| EN600-4T0185G/0220P | Optional | No | $\geq 27\Omega$ | 1PCS | $\geq 9KW$ | $\geq 1.8KW$ |
| EN600-4T0220G/0300P | Optional | No | $\geq 22\Omega$ | 1PCS | $\geq 11KW$ | $\geq 2.2KW$ |

| | | | | | | |
|---------------------|----------|----|-------------------|------|---------------|--------------|
| EN600-4T0300G/0370P | Optional | No | $\geq 19\Omega$ | 1PCS | $\geq 15KW$ | $\geq 3KW$ |
| EN600-4T0370G/0450P | Optional | No | $\geq 16.8\Omega$ | 1PCS | $\geq 18.5KW$ | $\geq 3.7KW$ |
| EN600-4T0450G/0550P | Optional | No | $\geq 13\Omega$ | 1PCS | $\geq 22KW$ | $\geq 4.5KW$ |
| EN600-4T0550G/0750P | Optional | No | $\geq 11\Omega$ | 1PCS | $\geq 28KW$ | $\geq 5.5KW$ |

ENC



Address: 5-6F, Bldg.4, Minqi Technology Park,
Lishan Rd., Nanshan Area, Shenzhen 518055, China

Website: <http://www.encvfd.com>

E-mail: encvfd@encvfd.com encvfd@enc.net.cn

Tel: +86-755-26984485 Fax: +86-755-26985120