



ISO9001:2015 Quality Management System Authentication

EDS300 Series

Ver.1.1

0.2-3.7KW

Users' Manual

SHENZHEN ENCOM ELECTRIC TECHNOLOGIES CO., LTD

Foreword

Encom EDS300 are designed and produced according to EN61800-5-1: 2007, EN 61010-1: 2010, EN61800-3: 2004+A1: 2012 standards.

Thank you for purchasing EDS300 series mini universal inverter from Shenzhen Encom Electric Technologies CO., LTD.

EDS300 series frequency converter adopts advanced control mode to realize high torque, high precision and wide speed regulation drive, which can meet various requirements of general frequency converter. EDS300 is the organic combination of general customer demand and industry demands, to provide a practical PID controller, a simple PLC, programmable input/output terminal control, remote synchronization control, pulse frequency and other special frequency converter control powerful functions. It is of great value to reduce the cost and improve the reliability of the system by providing the customers of equipment manufacturing and automation engineering with the integrated solution of high integration.

EDS300 use the space voltage vector PWM control and without sensor vector control technology and electromagnetic compatibility overall design, to meet the customer for the applicable place of large torque low noise, low electromagnetic interference environmental requirements.

Assembling wiring, parameter setting, troubleshooting and daily maintenance notice are available in this manual. To make sure that you can correctly assemble and operate EDS300 series inverters to exert their excellent performance, please read this user manual detailedly before you assemble the device and conserve the manual appropriately before the end-user get them.

Please contact our office or dealer in all places at any moment if you have any doubts or special demands when using these inverters, and you can also contact our after service center in our headquarters directly. We will serve you with all our heart.

We reserve our right to notice you if we change contents of this manual.

Contents

1 Safety information and use notice points	1
1.1 Safety Precautions	1
1.2 Use Range.....	2
1.3 Use Notice Points	2
1.4 Scrap Notice Points	3
2 Type and specification of the inverter	4
2.1 Incoming Inverter Inspect	4
2.2 Type Explanation	4
2.3 Nameplate explanation	4
2.4 Series type explanation.....	5
2.5 Appearance and parts name explanation.....	5
2.6 Outer size and gross weight	6
2.7 Outer size of keypad and its fixing box (unit: mm).....	6
2.8 Product Technic Index And Spec.....	7
3 Installation and wiring	9
3.1 Installation ambient	9
3.1.1 Demand for installation ambient.....	9
3.1.2 Installation direction and space.....	9
3.2 Parts disassembly and installation.....	10
3.2.1 Key board disassembly and installation.....	10
3.2.2 Plastic cover disassembly.....	10
3.3 Wiring notice points	10
3.4 Main loop terminal wiring.....	11
3.4.1 Connection between inverter and fitting parts.....	11
3.4.2 Main loop terminal wiring	12
3.5 Basic running wiring diagram.....	13
3.6 Control loop collocation and wiring	14
3.6.1 Location & function of terminal and jump-wire.....	14
3.6.2 Explanation for control CPU board	14
3.6.3 Analog input output terminal wiring.....	16
3.6.4 Communication terminal wiring	16
4 Function parameter schedule graph	18
4.1 Symbol description.....	18
4.2 Function parameter schedule graph	18
5 Trouble Shooting	31
5.1 Failure and countermeasure	31
5.2 Failure record lookup	34
5.3 Fault reset	34

6 Maintenance.....	35
6.1 Routine maintenance	35
6.2 Inspection and replacement of damageable parts	35
6.3 Repair guarantee.....	36
6.4 Storage.....	36
7 Modbus Communication Protocol.....	37
7.1 Summarization.....	37
7.2 Networking mode for communication networking.....	37
7.3 Communication mode	37
7.4 RTU communication Mode.....	38
7.5 Data communication address allocation.....	39
7.6 Communication error processing	41
7.7 Data frame examples	41
7.8 CRC check mode.....	43
Appendix A Serial port 485 communication protocol.....	44
Appendix B Braking Resistance	52



ENVO

1 Safety information and use notice points

In order to ensure the safety of your personal and equipment, before using the inverter please read this chapter of contents conscientiously.

1.1 Safety Precautions

There are three kinds of safe relevant warnings in this service manual, they are as follows:

Symbol	Symbol description
	This symbol explains items that need to be paid attention to when being operated.
 Note	This symbol is briefed on some useful information.
	This symbol briefs on: If does not operate on request, may cause death, severely injured or serious property loss.



- (1) Forbid to connect U, V, W output end to AC power supply, otherwise cause the complete damage of the inverter.
- (2) Don't make P- and P + short-circuited, otherwise cause the inverter to be damaged.
- (3) The inverter is forbidden to install on the flammables, otherwise have danger of fire.
- (4) Don't install it in the environment with explosive gas, otherwise have danger of causing explosion.
- (5) After connecting main loop, should carry on insulating treatment to bare wiring end, otherwise have danger of getting an electric shock.
- (6) If being connected to the power supply, don't operate the inverter with moist hands otherwise have danger of getting an electric shock.
- (7) The ground terminal of the inverter must be grounded well.
- (8) Inverter being connected to power supply, please don't open cover and carry on wiring, can connect the wire or check only after closing power for 10 minutes.
- (9) Only qualified personnel may carry on wiring and forbid leaving over any conductive thing in machine, otherwise have danger of getting an electric shock or causing damage of the inverter.
- (10) Inverter stored for over 2 years, should be stepped up gradually with voltage regulator first while having the electricity, otherwise have danger of getting electric shock and explosion.



- (1) It is prohibited that connect AC220V signal to control ends except TA, TB, TC, otherwise have danger of damaging property.
- (2) If the inverter is damaged or without all parts, please don't install and operate it, otherwise have danger of fire or cause personnel to be injured.
- (3) When installing, should choose a place where can endure the inverter, otherwise have danger of injuring personnel or damaging property while falling down.

1.2 Use Range

- (1) This inverter is only suitable for three phases AC asynchronous motor in general industrial field.
- (2) While applying inverter to such equipments that relate much to the life, great property, safety devices etc., must handle cautiously, and please consult with producer.
- (3) This inverter belongs to the control device of general industrial motor, if used in dangerous equipment, must consider the security safeguard procedures when the inverters breaks down.

1.3 Use Notice Points

- (1) EDS300 series inverter is voltage-type inverter, so temperature, noise and vibration slightly increasing compared to power source running when using, belongs to normal phenomenon.
- (2) If need to run for a long time with constant torque of low-speed, must select motor of frequency conversion for use. Use general asynchronous AC motor when running at a low speed, should control temperature of the motor or carry on heat dissipation measure forcedly, so as not to burn the generator.
- (3) Such mechanical device needing lubricating as the gearbox and gear wheel, etc., after running at a low speed for a long time, may be damaged as lubrication result become poor, please take necessary measure in advance.
- (4) When the motor running with frequency above specified, besides considering the vibration, noise increase of the motor, must also confirm speed range of the motor bearing and the mechanical device.
- (5) For hoist and great inertia load, etc., the inverter would shut off frequently due to over-current or over-voltage failure, in order to guarantee normal work, should consider choosing proper brake package.
- (6) Should switch on/off the inverter through terminal or other normal order channels. It is prohibited that switch on/off the inverter frequently by using strong electric switch such as magnetic control conductor, otherwise will cause the equipment to be damaged.
- (7) If need to install such switch as the magnetic control conductor, etc. between

inverter output and the motor, please guarantee the inverter is switched on/off without output, otherwise may damage the inverter.

(8) The inverter may meet with mechanical resonance of the load within certain range of frequency output, can set up jumping frequency to evade.

(9) Before using, should confirm the voltage of the power is within the working voltage range allowed, otherwise should vary voltage or order special inverter.

(10) In the condition of altitude above 1000 meters, should use the inverter in lower volume, reduce output current by 10% of specified current after each 1500 meters height increasing.

(11) Should make insulation check to the motor before using it for the first time or after a long time placement. Please inspect with 500V voltage-type megohm meter according to method shown as graph1-1 and insulation resistance should not be smaller than 5 MΩ, otherwise inverter may be damaged.

(12) To forbid assembling capacitor for improving power factor or lightning proof voltage-sensible resistance etc., otherwise will cause malfunction trip of the inverter or damage of the parts, shown as graph 1-2.

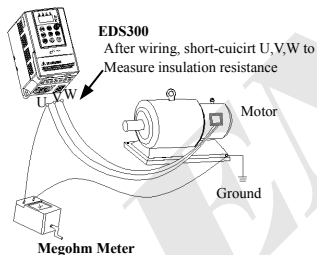

Fig.1-1 Motor insulation measure

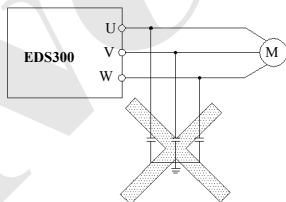

Fig.1-2 Capacitor at output side forbidden

1.4 Scrap Notice Points

When disposing scrap inverter and its parts, please note:

- (1) The unit: Please discard as industrial useless.
- (2) Electrolytic capacitor: When burning the inverter electrolytic capacitor in it may explode.
- (3) Plastic: When plastic, rubber parts etc. in the inverter are burning, they may bring bad, poisonous gas, so please be ready to safeguards.

2 Type and specification of the inverter

2.1 Incoming Inverter Inspect

(1) Check if there is damage during transportation and inverter itself has damage or fall-off parts.

(2) Check if parts presented in packing list are all ready.

(3) Please confirm rated data of the inverter is in line with your order requirement.

Our product is guaranteed by strict quality system during manufacturing, packing, transportation etc., please contact our company or local agent rapidly if some careless omission or mistake arise, we'll deal with it as soon as possible.

2.2 Type Explanation

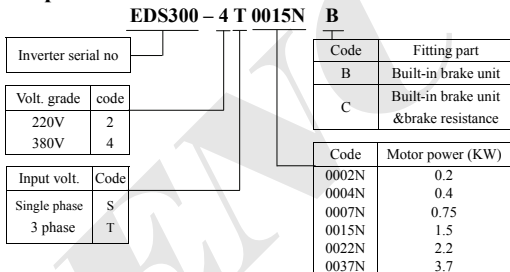

Fig. 2-1 Type Description



If the inverter hasn't relevant content or can be defaulted, code after "/" will be ignored.

2.3 Nameplate explanation

Nameplate presented as figure 2-2 with type and rating data at the bottom of inverter right side.

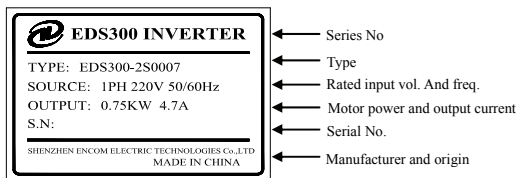

Fig.2-2 Nameplate

2.4 Series type explanation

Table 2-1 series type explanation

Inverter type	Rated power (KVA)	Rated output current(A)	Adapted motor (KW)
EDS300-2S0002	0.6	1.6	0.2
EDS300-2S0004	1.1	3	0.4
EDS300-2S0007	1.8	4.7	0.75
EDS300-2S0015	2.8	7.5	1.5
EDS300-2S0022	3.8	10	2.2
EDS300-4T0007	1.5	2.3	0.75
EDS300-4T0015	2.4	3.7	1.5
EDS300-4T0022	3.3	5	2.2
EDS300-4T0037	5.6	8.5	3.7

2.5 Appearance and parts name explanation

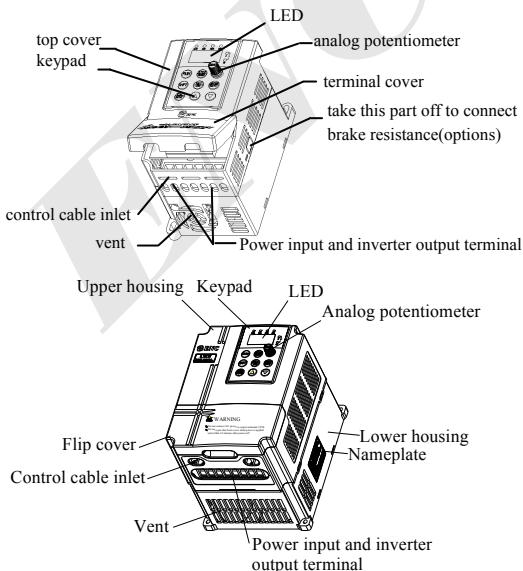

Fig. 2-3 Parts Name Sketch For EDS300

2.6 Outer size and gross weight

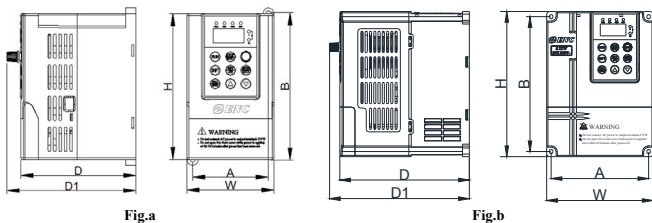

Fig.2-4 Outline Image

Table 2-2 EDS300-2S0002N~EDS300-4T0015N Mounting size

Inverter type	W (mm)	H (mm)	D (mm)	D1 (mm)	A (mm)	B (mm)	Fixing aperture (mm)	Gross weight (kg)	Fig. No.
EDS300-2S0002	89	148.5	112.5	124.7	74	138	5	1	Fig.a
EDS300-2S0004	89	148.5	112.5	124.7	74	138	5	1	Fig.a
EDS300-2S0007	89	148.5	112.5	124.7	74	138	5	1.1	Fig.a
EDS300-2S0015	89	148.5	112.5	124.7	74	138	5	1.2	Fig.a
EDS300-2S0022	125	170	152.1	164.1	114.5	158	5	1.9	Fig.b
EDS300-4T0007	89	148.5	112.5	124.7	74	138	5	1.1	Fig.a
EDS300-4T0015	89	148.5	112.5	124.7	74	138	5	1.1	Fig.a
EDS300-4T0022	125	170	152.1	164.1	114.5	158	5	1.9	Fig.b
EDS300-4T0037	125	170	152.1	164.1	114.5	158	5	1.9	Fig.b

2.7 Outer size of keypad and its fixing box (Unit: mm)

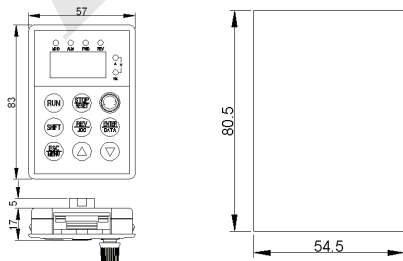

Fig.2-5 Outer size of keypad and outline of its fixing box

2.8 Product Technic Index And Spec.

Item		Item description	
Input	Rating volt. frequency	3 phase 380V, 50Hz/60Hz; Single phase 220V, 50Hz/60Hz	
	Allowed work volt. range	3 phase voltage: 320V~460V; Single phase voltage: 200V~260V	
Output	Voltage	400V grade: 0~380V; 200V grade: 0~220V	
	Frequency	0Hz~400Hz	
	Over loading capacity	150% of rating current for 1 minute, 200% of rating current for 0.5 second;	
Control performance	Control mode	Optimum space voltage vector SVPWM constant volt. Frequency ratio V/F control	
	Speed regulation range	1:100	
	Start-up torque	100% of rating torque at low frequency	
	Running speed stable state precision	$\leq \pm 0.5\%$ of rating synchronous speed	
	Frequency precision	Analog setting: max. frequency $\times \pm 0.5\%$	
	Frequency resolution	Analog setting	0.1% of max. frequency
		Digital setting	0.01Hz
	Torque boost	Automatic torque boost, manual torque boost 0.1%~20.0%	
	V/F curve (volt. Frequency characteristic)	Set rating frequency randomly at range of 5~400Hz, can choose constant torque, degressive torque 1, degressive torque 2, degressive torque 3 in total 4 kinds of curve	
	Accelerating decelerating curve	2 modes: straight line accelerating decelerating and S curve accelerating decelerating; 7 kinds of accelerating decelerating time (unit minute/second can be optioned), max. time 6000 minutes	
	Brake	Power consumption brake	exterior brake resistance
		DC brake	Optional start-up and stop, action frequency 0~15Hz, action volt. 0~15%, action time 0~20.0 s
	Jog	Jog frequency range: 0.50Hz~50.00Hz; jog accelerating decelerating time 0.1~60.0s can be set	
	Multisection speed running	Realized by interior PLC or control terminal	
	Interior PID controller	Be convenient to make closed-loop system	
	Automatic energy save running	Optimize V/F curve automatically based on the load to realize power save running	
	Automatic volt. regulation (AVR)	Can keep constant output volt. When power source voltage varies.	
Automatic current limiting	Limit running current automatically to avoid frequent over-current which will cause trip		
Running function	Running order specified channel	Key pad specified, control terminal specified, serial port specified	
	Running frequency specified channel	Digital provision, analog provision, impulse provision, serial port provision, combined provision, can be switched at any time by kinds of method	

Type and specification of the inverter

Keypad	LED display	Can display setting frequency, output frequency, output voltage, output current etc. in total 14 kinds of parameter
	Lock the button	Lock all or part of the buttons(analog potentiometer can't be locked)
Protection function		Over-current protection, over-voltage protection, lack-voltage protection, over-heat protection, over-load protection, missing phase protection (in option)etc.
Fitting parts		brake subassembly, remote-control keypad, connecting cable for remote-control keypad etc.
Ambient	Use ambient	Indoor, not bare to sunlight, no dust, no corrosive gas, no flammable gas, no oil fog, no vapor, no water drop or salt etc.
	Altitude	Lower than 1000m
	Ambient temperature	-10°C~+40°C(under ambient temperature 40°C ~50°C, please reduce the volume or strengthen heat sink)
	Ambient humidity	Smaller than 95%RH, no condensation water
	Vibration	Smaller than 5.9m/s ² (0.6g)
Storage temperature		-40°C~+70°C
Configu	Defending grade	IP20
	Mounting mode	Wall hanging



Note

To exert excellent performance of this inverter, please choose correct type and check note relevant content according to this chapter before wiring for use.



Must choose correct type, otherwise may cause abnormal running of the motor or damage.

3 Installation and wiring

3.1 Installation ambient

3.1.1 Demand for installation ambient

(1) Installed in drafty indoor place, ambient temperature within $-10^{\circ}\text{C}\sim 40^{\circ}\text{C}$, need external compulsory heat sink or reduce the volume if temperature exceeds 40°C .

(2) Avoid installing in place with direct sunlight, much dust, floating fibre and metal powder.

(3) Forbid to install in place with corrosive, explosible gas.

(4) Humidity should be smaller than 95%RH, without condensation water.

(5) Installed in place of plane fixing vibration smaller than 5.9m/s^2 (0.6g).

(6) Keep away from electromagnetic disturbance source and other electronic apparatus sensible to electromagnetic disturbance.

3.1.2 Installation direction and space

(1) Normally the inverter should be mounted vertically, horizontal mounting will seriously affect heat dissipation and the inverter must be used in lower volume.

(2) Demand for minimum mounting space and distance, please see Fig.3-1.

(3) When install multiple inverters up and down, must apply leading divider between them, see fig.3-2

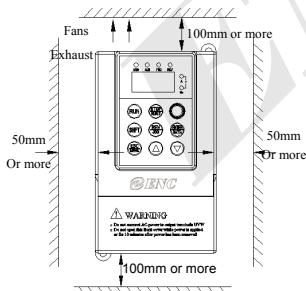

Fig. 3-1 Mounting space

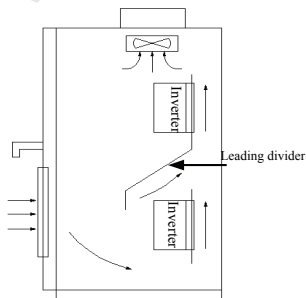

Fig. 3-2 Mounting of multiple inverters

3.2 Parts disassembly and installation

3.2.1 Key board disassembly and installation

(1) Disassembly

Let the forefinger press finger inlet on the keypad, Depress fixing flexible plate on the top lightly, Draw it outward, then you can disassemble the keypad.

(2) Assembly

First place the fixing hook at the bottom of keypad onto mounting claw on keypad mounting hole, let forefinger press fixing flexible plate on top of keypad and then push it inside, release it in proper location (after a crisp sound).

3.2.2 Plastic cover disassembly

Put the finger into handle hole on the bottom of cover, lift it, then you can disassemble the cover.

3.3 Wiring notice points



- (1) Assure power cut off completely for above 10 minutes before wiring, otherwise have danger of getting electric shock.
- (2) Forbid connecting power wire to output U, V, W of the inverter.
- (3) There is current leakage in the inverter and leak current of middle/high power inverter is bigger than 5mA, for safety reason, inverter and motor must be earthed safely, commonly use 3.5mm² above copper wire as ground wire and ground resistance smaller than 10Ω.
- (4) Before shipment compression resistance test of the inverter is passed, so user should not conduct compression resistance test again.
- (5) Should not assemble electromagnetic contactor and absorbing capacitance or other absorbing device, see Fig.3-3.
- (6) To be convenient to over current protect of input side and power off maintenance inverter should be connected to power supply through relay.
- (7) Connecting wire for relay input and output loop(X1, X2, FWD, REV), should use above 0.75mm² glued wire or shielding wire, one shielding layer end hung in the air, the other connected to grounding end (⊕), connecting wire shorter than 20m.



- (1) Before wiring, assure power supply is cut off completely for 10 minutes and all LED indicator light extinguished.
- (2) Wiring can only be done by professional person trained and qualified.
- (3) Before electrification, check if voltage grade of the inverter is in line with that of power supply volt., otherwise will cause personnel injured and device damaged.

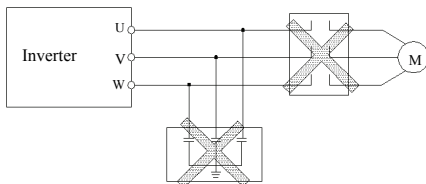

Fig.3-3 Banned magnetic control conductor and absorbing capacitance between inverter and motor

3.4 Main loop terminal wiring

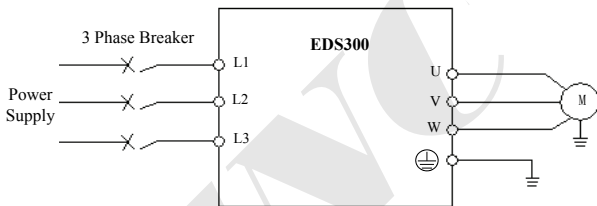

Fig.3-4 Main loop simple wiring

3.4.1 Connection between inverter and fitting parts

(1) Must assemble disjunction device such as isolation switch etc. between power source and the inverter to assure personal safety when repairing the inverter and needing compulsory power off.

(2) Power supply loop must have breaker or fuse with over current protection function to avoid malfunction expanding caused by failure of after device.

(3) AC input reactor

If high-order harmonics between inverter and Power supply is biggish which can't fulfil system requirement, or need to improve input side power factor, AC input reactor is needed.

(4) Magnetic control conductor only be applied to power supply control and don't apply magnetic control conductor to controlling on/off of the inverter.

(5) Input side EMI filter

Can use EMI filter to inhibit high-frequency conduction disturbance and emission disturbance from inverter power supply wire.

(6) Output side EMI filter

Can use EMI filter to inhibit emission disturbance noise and wire leakage current from output side.

(7) AC output reactor

Advise assembling AC output reactor to avoid motor insulation damage, too large over current and inverter frequent protection when connecting wire from inverter to motor exceeds 50m. But voltage drop of AC output reactor must be considered. Improve input output voltage of the inverter or let the motor in lower volume to avoid burning off the motor.

(8) Complete ground wire

Inverter and motor must be earthed and grounding resistor smaller than 10Ω . Grounding wire should be shorter enough and wire diameter be bigger enough (not smaller than 3.5mm^2).

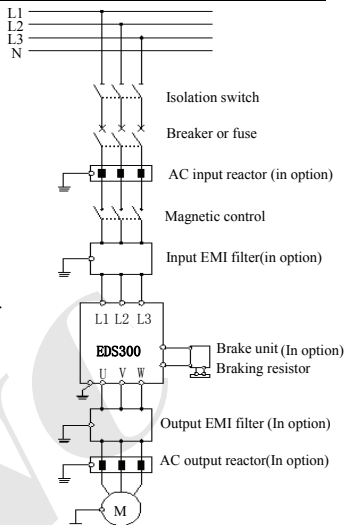

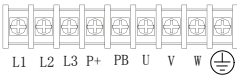

Fig.3-5 Connection of inverter and parts fitting parts

3.4.2 Main loop terminal wiring

For main loop input output terminal, see table 3-1.

Table 3-1 Main loop input output terminal description

Adapted type	Main loop terminal	End name	Function description
EDS300-2S0002 ~ EDS300-2S0015		L1	Zero wire
		L2	live wire
		⊕	Grounding terminal
		U、V、W	3 phase AC output end
EDS300-2S0022		L1	Zero wire
		L2	live wire
		P+	DC volt. Positive terminal
		PB	External connect to brake resistor reverse terminal
		U、V、W	3 phase AC output end
		⊕	Grounding terminal
EDS300-4T0007 EDS300-4T0015		L1、L2、L3	3 phase AC input end
		⊕	Grounding terminal
		U、V、W	3 phase AC output end

EDS300-4T0022 EDS300-4T0037		L1、L2、L3	3 phase AC input end
		P+	DC volt. Positive terminal
		PB	External connect to brake resistor reverse terminal
		U、V、W	3 phase AC output end
			Grounding terminal

3.5 Basic running wiring diagram

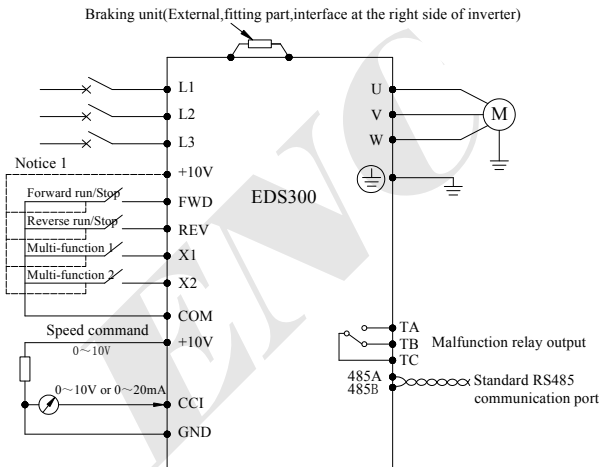

Fig. 3-6 Basic wiring diagram

Note 1: FWD, REV, X1, X2 only supports low-level validity.

3.6 Control loop collocation and wiring

3.6.1 Location & function of terminal and jump-wire:

For location of terminal and switch on the CPU board, please see Fig.3-7.

Function description of terminal provided for the user, please see Table 3-2, function and setup description of switch, please see Table 3-3. Should carry on terminal wiring correctly and set switch on the CPU board before using the inverter, to use at least No.24 conducting wire as terminal connecting wire is recommended.

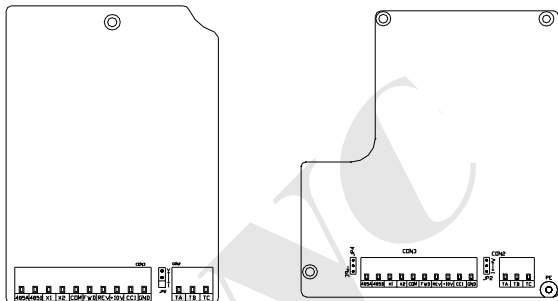

Fig. 3-7 Switch on CPU board

Table 3-2 function description of terminal provided for user

Symbol	Function	Description
CON2	Malfunction relay signal output	Always-open connect pin of the relay closed when malfunction in inverter occurs
CON3	External terminal input/output control	Use this port when external terminal control inverter running

Table 3-3 function description of switch provided for user

Symbol	Function	Factory default
JP2	Analog CCI input, 0~10V exchange with 4~20mA. When be put on "V" side, for 0~10V input; when be put on "I" side, for 4~20mA input.	0~10V

3.6.2 Explanation for control CPU board

(1) Control loop terminal CON3 arranged as follows:

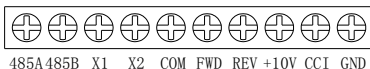

(2) CN2 terminal function description as Table 3-4.

Table 3-4 CPU board CN2 terminal function table

Item	Symbol	Name	Function description	Spec
Run command	FWD	Forward run command	Forward reverse run command, see F5.08 group double-wire and three-wire control function description	Enter impedance: R=2kΩ Max input frequency: 200Hz
	REV	Reverse run command		
Multi-function input terminal	X1	Multi-function input 1	Programmable is defined as a switching volume input terminal for a variety of functions.	
	X2	Multi-function input 2		
	+10V	+10V power supply	Provide +10V power supply. (negative pole: GND)	
	COM	end+12V power supply negative pole	12V grounds	
	GND	+10V power supply negative pole	Reference ground of analog signal and +10V power supply.	
Analog value input	CCI	Analog value input CCI	Accept analog voltage/current input. Voltage ,current optioned by JP2, factory default is voltage. (reference ground: GND)	Input voltage range: 0~10V (input impedance: 70kΩ) Input current range: 4~20mA(input impedance: 250Ω) Resolution: 1/1000

(3) RS485 terminal function description as table 3-5

Table 3-5 CPU board RS485 terminal function table

Item	Symbol	Name	Function description	Spec
Communication	485A	485 Communication interface.	485 Difference signal positive end	For standard 485 communication interface, please use twisted-pair or STP
	485B		485 Difference signal negative end	

(4) Control terminal CON2, arranged as follows:

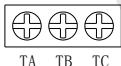

(5) CON2 terminal function description as Table 3-6.

Table 3-6 CPU board CON2 terminal function

Item	Symbol	Name	Function description	Spec
Relay output terminal	TA	Inverter malfunction output relay	Normal: TB-TC closed, TA-TC open Malfunction: TB-TC open, TA-TC closed	TB-TC: always-closed, TA-TC: always-open contact capacity: AC250V/2A (COSΦ=1) AC250V/1A (COSΦ=0.4) DC30V/1A
	TB			
	TC			

3.6.3 Analog input output terminal wiring

(1) CCI terminals accept analog voltage signal input, input voltage(0-10V), input current(0-20mA). Wiring as follow:

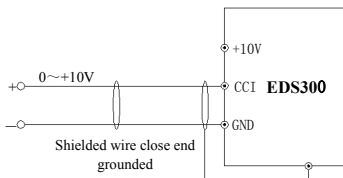

Fig.3-8 CCI terminal wiring diagram



Note

(1) When input analog signal, can connect filter capacitor or common mode inductance between CCI and GND.

(2) Analog input, output signal is easy to be disturbed, so must use shielded cable when wiring and well grounded, wiring length should be as short as possible.

3.6.4 Communication terminal wiring

EDS300 inverter provides 485 serial communication interface for the user.

Following wiring methods make single-main single-sub control system or single-main multi-sub control system possible. Using upper machine(PC or PLC controller) software can realize real time supervision to inverter in the industrial control system so that realize complicated run control such as long-distance control, high automatization etc; you can also use one inverter as mainframe and the others as submachine to form cascade or synchronous control network.

(1) When inverter 485 interface connected to other devices with 485 interface, you can connect wire as below figure.

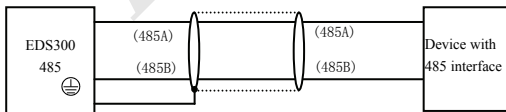

Fig.3-9 communication terminal wiring

(2) To connect remote control keypad, you can connect plug of remote control keypad to RS485 directly. No need to set any parameter, inverter local keypad and remote control keypad can work at the same time.

(3) Connection between inverter RS485 interface and upper machine (with RS232 interface):

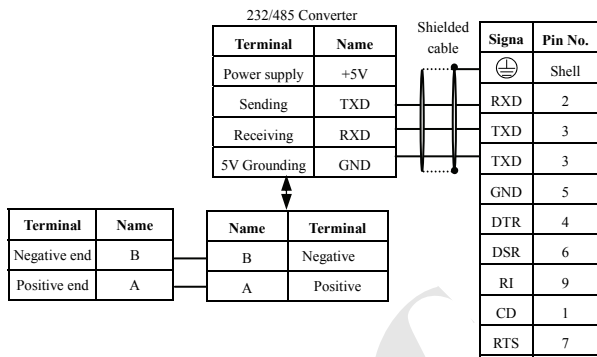
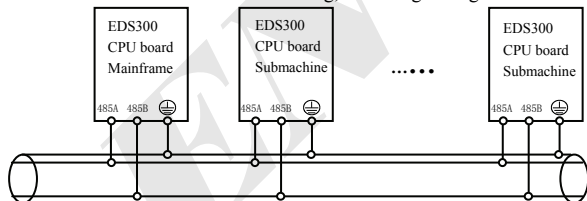

Fig. 3-10 RS485 communication wiring

(4) Multiple inverters can be connected together per RS485 and 31pcs inverter can be connected together at most. Communication system is more prone to disturbance as connected inverters increasing, following wiring is recommended:



**Fig. 3-11 Recommended wiring for multiple inverters communication
(all inverters and motors well earthed)**

Normal communication still not available if using above wiring, can try to take following measure:

- 1> Provide separate power supply for PLC (or upper machine) or isolate its power supply.
- 2> Apply magnetic circle on the communication wire.
- 3> Reduce inverter carrier wave frequency properly.

- (1) When form the network only by inverters, you must set local address parameter F2.15 of the mainframe EDS300 to 0.
- (2) For programming of RS485 interface, please refer to chapter 7 MODBUS communication protocol.



Note

4 Function parameter schedule graph

4.1 Symbol description

- × --- Parameter can't be changed in process of running
- --- Parameter can be changed in process of running
- * --- Read-only parameter, unmodifiable

4.2 Function parameter schedule graph

F0—Basic run function parameter group					
Function code	Name	Set range	Unit	Factory default	Modification
F0.00	Frequency input channel selection	0: Keypad analog potentiometer setting 1: Keypad digital setting 2: Terminal UP/DOWN adjust setting (stored after power off) 3: Serial port setting 4: Reserved 5: CCI analog setting (CCI-GND) 6: Reserved 7: Reserved 8: Combination setting 9: Terminal UP/DOWN adjust setting (not stored after power off) 10: Provision series port (stored after power off) 11: Remain	1	1	○
F0.01	Frequency digit setting	Lower limit frequency~upper limit frequency	0.01Hz	50.00Hz	○
F0.02	Run command channel selection	0: Keyboard run control 1: Terminal run command control (Keyboard STOP command ineffective) 2: Terminal run command control(Keyboard STOP command effective) 3: Serial port run command control(Keyboard STOP command ineffective) 4: Serial port run command control(Keyboard STOP command effective)	1	0	○
F0.03	Run direction setting	LED Units digit: 0: Forward run 1: Reverse run LED Tens digit: 0: Reverse run allowed 1: Reverse run banned LED Hundreds digit: REV/JOG key selection 0: As reverse run key 1: Reverse run banned	1	100	○
F0.04	Acce/Dece mode selection	0: Linear accelerating decelerating mode 1: S curve accelerating decelerating mode	1	0	×
F0.05	S curve start section time	10.0 (%) ~50.0 (%) (Acce/Dece time) F0.05+F0.06≤90 (%)	0.1(%)	200(%)	○
F0.06	S curve risetime	10.0 (%) ~70.0 (%) (Acce/Dece time) F0.05+F0.06≤90 (%)	0.1(%)	600(%)	○

Function parameter schedule graph

F0.07	Accelerating decelerating time unit	0: Second 1: Minute	1	0	×
F0.08	Acce time 1	0.1~6000.0	0.1	20.0	○
F0.09	Dece time 1	0.1~6000.0	0.1	20.0	○
F0.10	Upper limit freq.	Lower limit freq.~400.00Hz	0.01Hz	50.00Hz	×
F0.11	Lower limit freq.	0.00~Upper limit freq.	0.01Hz	0.00Hz	×
F0.12	Lower limit freq. run mode	0: Run at lower limit freq. 1: Stop running	1	0	×
F0.13	Torque boost mode	0: Manual boost 1: Automatic boost	1	0	○
F0.14	Torque boost	0.0~20.0 (%)	0.1(%)	4.0(%)	○
F0.15	V/Fcurve setting	0: Constant torque curve 1: Degressive torque curve 1 (The 2.0nd power) 2: Degressive torque curve 2 (The 1.7th power) 3: Degressive torque curve 3 (The 1.2th power) 4: End-user sets VF curve himself (determined by F2.37~F2.44) F2.37 VF Freq. value 0 F2.38 VF voltage value 0 F2.39 VF Freq. value 1 F2.40 VF voltage value 1 F2.41 VF Freq. value 2 F2.42 VF voltage value 2 F2.43 VF Freq. Value 3 F2.44 VF voltage 3 Remark: VF frequency and voltage can't be 0or maximum	1	0	×
F0.16	Reserved				



F1-Start-up, stop, Brake function parameter group

Function Code	Name	Set Range	Unit	Factory default	Modification
F1.00	Start-up run mode	0: Start at start-up freq. 1: First brake, then start at start-up freq. 2: Reserved	1	0	×
F1.01	Start-up freq.	0.0~10.00Hz	0.01Hz	0.00Hz	○
F1.02	Start-up freq. duration	0.0~20.0S	0.1s	0.0s	○
F1.03	Zero freq. DC braking volt.	0~15 (%)	1	0	○
F1.04	Zero freq. DC braking time	0.0~20.0S	0.1s	0.0s	○
F1.05	Stop mode	0: Dec stop 1: Free stop 2: Dec+DC brake stop	1	0	×
F1.06	DC brake initiative freq. when stop running	0.0~15.00Hz	0.01Hz	0.00Hz	○
F1.07	DC brake time when stop running	0.0~20.0s	0.1s	0.0s	○
F1.08	DC brake voltage when stop running	0~15 (%)	1	0	○

Function parameter schedule graph

F2-Auxiliary run function parameter group					
Function code	Name	Set range	Unit	Factory default	Modification
F2.00	Analog filter time constant	0.00~30.00s	0.01s	0.20s	○
F2.01	Forward reverse run dead-section time	0.0~3600.0s	0.1s	0.1s	○
F2.02	Automatic energy save run	0: No action 1: Action	1	0	×
F2.03	AVR function	0: No action 1: Action all the time 2: No action only during Dec	1	0	×
F2.04	Slip frequency compensation	0~150(%)0-no slip frequency compensation	1	0	×
F2.05	Carrier wave freq.	2~15.0K	0.1K	depend on machine type	×
F2.06	Jog run frequency	0.10~50.00Hz	0.01Hz	5.00Hz	○
F2.07	Jog Acc time	0.1~60.0s	0.1s	20.0s	○
F2.08	Jog Dec time	0.1~60.0s	0.1s	20.0s	○
F2.09	Frequency input channel combination	0~14: Reserved 15: 485+CCI 16: 485-CCI 17: Reserved 18: Reserved 19: RS485+keypad potentiometer 20: 485-keypad potentiometer 21: Reserved 22: Reserved 23: CCI+keypad potentiometer 24: CCI-keypad potentiometer 25: CCI*QWG (keypad potentiometer) 26~28: Reserved	1	0	×
F2.10	Principal subordinate Machine communication frequency provision proportion	0~500 (%)	1(%)	100(%)	○
F2.11	LED display control 1	0000~1111 LED Units digit: Running time 0: Not display 1: Display LED Tens digit: Accumulative time 0: Not display 1: Not display LED Hundreds digit: Input terminal status 0: Not display 1: Display LED Thousands digit: Output terminal status 0: Not display 1: Display	1	1111	○

Function parameter schedule graph

F2.12	LED display control 2	0000~1111 LED Units digit: Reserved LED Tens digit: Analog input CCI 0: Not display 1: Display LED Hundreds digit: Reserved LED Thousands digit: Reserved	1	0110	○
F2.13	Parameter operation control	LED Units digit: 0: All parameters allowed to be modified 1: Except this parameter, all other parameters are not allowed to be modified 2: Except F0.01 and this parameter, all other parameters are not allowed to be modified LED Tens digit: 0: No action 1: Restore default value 2: Clear history failure record LED Hundreds digit (After setting, it will be valid after pressing MENU key for 5 seconds and entering into Locc status) 0: Lock all buttons 1: Lock all buttons but not STOP key 2: Lock all buttons but not   STOP key 3: Lock all buttons but not RUN, STOP key 4: Lock all buttons but not SHIFT, STOP key	1	000	×
F2.14	Communication configuration	LED Units digit: Baud rate selection 0: 1200BPS 1: 2400BPS 2: 4800BPS 3: 9600BPS 4: 19200BPS 5: 38400BPS LED Tens digit: 0: 1-8-1 format, No checkout 1: 1-8-1 format, Even checkout 2: 1-8-1 format, Odd checkout LED Hundreds digit: Response selection 0: Respond to host command and reply to data packet 1: Respond to host command, but not reply Thousand digit: Protocol selection 0: Modbus protocol 1: Free protocol	1	0003	×
F2.15	Local address	0~127, 0 is broadcast address	1	1	×
F2.16	Communication overtime	0.0~1000.0s, 0 means communication timeout detection invalid.	0.1s	0.0s	×
F2.17	Local responson delay	0~200ms	1ms	5ms	×
F2.18	Acce time 2	0.1~6000.0	0.1	20.0	○
F2.19	Dece time 2	0.1~6000.0	0.1	20.0	○
F2.20	Acce time 3	0.1~6000.0	0.1	20.0	○
F2.21	Dece time 3	0.1~6000.0	0.1	20.0	○

Function parameter schedule graph

F2.22	Acce time 4	0.1~6000.0	0.1	20.0	○
F2.23	Dece time 4	0.1~6000.0	0.1	20.0	○
F2.24	Acce time 5	0.1~6000.0	0.1	20.0	○
F2.25	Dece time 5	0.1~6000.0	0.1	20.0	○
F2.26	Acce time 6	0.1~6000.0	0.1	20.0	○
F2.27	Dece time 6	0.1~6000.0	0.1	20.0	○
F2.28	Acce time 7	0.1~6000.0	0.1	20.0	○
F2.29	Dece time 7	0.1~6000.0	0.1	20.0	○
F2.30	Multisection freq. 1	Lower limit freq. ~ upper limit freq.	0.01Hz	5.00Hz	○
F2.31	Multisection freq. 2	Lower limit freq. ~ upper limit freq.	0.01Hz	10.00Hz	○
F2.32	Multisection freq. 3	Lower limit freq. ~ upper limit freq.	0.01Hz	20.00Hz	○
F2.33	Multisection freq. 4	Lower limit freq. ~ upper limit freq.	0.01Hz	30.00Hz	○
F2.34	Multisection freq. 5	Lower limit freq. ~ upper limit freq.	0.01Hz	40.00Hz	○
F2.35	Multisection freq. 6	Lower limit freq. ~ upper limit freq.	0.01Hz	45.00Hz	○
F2.36	Multisection freq. 7	Lower limit freq. ~ upper limit freq.	0.01Hz	50.00Hz	○
F2.37	Multisection freq. 8	Lower limit freq. ~ upper limit freq.	0.01Hz	0.50Hz	○
	VF frequency value 0	0.00~F2.39	0.01Hz	0.50Hz	○
F2.38	Multisection freq.9	Lower limit freq. ~ upper limit freq.	0.01Hz	2.00Hz	○
	VF voltage value 0	0.00~F2.40	0.01%	2.00%	○
F2.39	Multisection freq. 10	Lower limit freq. ~ upper limit freq.	0.01Hz	20.00Hz	○
	VF frequency value 1	F2.37~F2.41	0.01Hz	20.00Hz	○
F2.40	Multisection freq. 11	Lower limit freq. ~ upper limit freq.	0.01Hz	38.00Hz	○
	VF voltage value 1	F2.38~F2.42	0.01%	38.00%	○
F2.41	Multisection freq.12	Lower limit freq. ~ upper limit freq.	0.01Hz	25.00Hz	○
	VF frequency value 2	F2.39~F2.43	0.01Hz	25.00Hz	○
F2.42	Multisection freq. 13	Lower limit freq. ~ upper limit freq.	0.01Hz	48.00Hz	○
	VF voltage value 2	F2.40~F2.44	0.01%	48.00%	○
F2.43	Multisection freq.14	Lower limit freq. ~ upper limit freq.	0.01Hz	40.00Hz	○
	VF voltage value 3	F2.41~upper limit freq.	0.01Hz	40.00Hz	○
F2.44	Multisection freq.15	Lower limit freq. ~ upper limit freq.	0.01Hz	80.00Hz	○
	VF voltage value 3	F2.42~100.0%(voltage value)	0.01%	80.00%	○
F2.45	Jumping freq. 1	0.00~400.00Hz	0.01Hz	0.00Hz	×
F2.46	Jumping freq. 1 range	0.00~30.00Hz	0.01Hz	0.00Hz	×
F2.47	Jumping freq. 1 range	0.00~400.00Hz	0.01Hz	0.00Hz	×
F2.48	Jumping freq. 2 range	0.00~30.00Hz	0.01Hz	0.00Hz	×
F2.49	Jumping freq. 3	0.00~400.00Hz	0.01Hz	0.00Hz	×
F2.50	Jumping freq. 3 range	0.00~30.00Hz	0.01Hz	0.00Hz	×
F2.51	Setting run time	0~65535 hours	1	0	○
F2.52	Accumulative run time	0~65535 hours	1	0	*
F2.53	Encryption time	0~65535 hours	1	0	○

F3—group—closed-loop run function parameter group

Function code	Name	Set Range	Unit	Factory default	Modification
F3.00	Closed-loop run control selection	0: Closed-loop control ineffective 1: PID closed-loop control effective 2: Constant pressure water supply PID control Specialized (one tows one)	1	0	×
F3.01	Provision channel selection	0: Digital provision 1: Reserved	1	0	○

Function parameter schedule graph

		2: CCI analog provision 3: Keypad potentiometer provision			
F3.02	Feedback channel selection	0: Reserved 1: CCI analog input	1	0	○
F3.03	Specified value digital setting	0.000~9.999V (SetF3.00=1, F3.21=9.999)	0.001	0.200	○
	Target pressure value setting	0.000~F3.21Mpa (set F3.00=2)	0.001	0.200	○
F3.04	Minimum specified value	0.0~Maximum specified value; percentage relative to 10.00V	0.1(%)	0.0(%)	○
F3.05	Feedback value responding to minimum specified value	0.0(%)~100.0(%)	0.1(%)	0.0(%)	○
F3.06	Maximum specified	Minimum specified value~100.0 (%)	0.1(%)	100.0(%)	○
F3.07	Feedback value responding to maximum specified value	0.0%~100.0%	0.1(%)	100.0(%)	○
F3.08	Proportion gain Kp	0.000~9.999	0.001	0.150	○
F3.09	Integral gain Ki	0.000~9.999	0.001	0.150	○
F3.10	Differential gain Kd	0.000~9.999	0.001	0.000	○
F3.11	Sampling cycle T	0.01~1.00s	0.01s	0.10s	○
F3.12	Deviation margin	0.0~20.0(%) Relative to the percentage of set value.	0.1(%)	2.0(%)	○
F3.13	Integral separation PID adjusting threshold	0.0~100.0(%)	0.1(%)	100.0(%)	○
F3.14	Closed-loop preset frequency	0~upper limit frequency	0.01Hz	0.00Hz	○
F3.15	Closed-loop preset frequency holding time	0.0~6000.0s	0.1s	0.0s	○
F3.16	Sleep frequency threshold	0.00~400.00Hz	0.01Hz	30.00Hz	○
F3.17	Revival pressure threshold	0.000~F3.21Mpa	0.001	0.150	○
F3.18	Sleep delay time	0.0~6000.0s	0.1s	0.0s	○
F3.19	Revival delay time	0.0~6000.0s	0.1s	0.0s	○
F3.20	Reserved				
F3.21	Long-distance pressure meter range	0.000~9.999Mpa	0.001	1.000	○
F3.22	Reserved				
F3.23	Reserved				
F3.24	Reserved				
F3.25	Reserved				
F3.26	Water supply supervision parameter display	0: C-11reserved, C-12 display CCI voltage value 1: C-11, C-12 display PID specified pressure and feedback pressure	1	0	○
F3.27	Closed-loop adjusting characteristic	0: Forward function 1: Reverse function	1	0	○
F3.28	LED initial	0: Set frequency	1	1	○

Function parameter schedule graph

	supervision parameter selection	1: Output frequency 2: Output current 3: Output voltage 4: DC bus bar voltage 5: Motor speed 6: Heat sink temperature 7: Run time 8: Accumulative run time 9: Input terminal status 10: Output terminal status 11: Analog input VCI/PID provision 12: Analog input CCI/PID feedback 13: Reserved 14: Reserved			
F3.29	PID feedback signal loss detection	0.0~9.999s	0.1s	0.0s	○
F3.30	Failure relay TA, TB, TC function selection	0: Inverter running (RUN) 1: Frequency arriving signal (FAR) 2: Frequency level detect signal (FDT1) 3: Reserved 4: Overload warning alarm signal (OL) 5: Output frequency reach high limit (FHL) 6: Output frequency reach low limit (FLL) 7: Inverter under voltage blockage stop (LU) 8: External failure stop-running (EXT) 9: Inverter zero speed running 10: PLC running 11: Simple PLC section running finished 12: PLC finish a cycle running 13: Reserved 14: Inverter ready to run(RDY) 15: Inverter failure 16: Traverse high and low limit restriction 17: Interior counter reach final value 18: Interior counter reach specified value 19: Set run time arriving 20: Interior timing arriving 21: Reserved 22: FWD running 23: REV running 24: Reserved	1	15	○
F3.31	Reserved				

F4—simple PLC function parameter group

Function code	Name	Set range	Unit	Factory default	Modification
F4.00	Simple PLC running setting	LED unit digit: 0: No action 1: Stop after single circulation 2: Keep final value after single circulation 3: Consecutive circulation	1	0000	×

Function parameter schedule graph

		LED Tens digit: 0: Start again from first section 1: Continue to run at mid-section frequency 2: Continue to run from operation frequency of interruption moment LED Hundreds digit: PLC run time unit 0: Second 1: Minute LED Thousands digit: PLC running state power off treatment method 0: Power off no memory 1: Running with memory when power off, renew running after power on (terminal control exceptional) 2: Running with memory when power off, automotive running after power on			
F4.01	Section 1 setting	000—621 LED Units digit: Frequency setting 0: Multisection freq. i (i=1~7) 1: Freq. determined by F0.00 function code LED Tens digit: Run direction selection 0: Forward run 1: Reverse run 2: Determined by run command LED Hundreds digit: Acc/Dec time selection 0: Acc/Dec time 1 1: Acc/Dec time 2 2: Acc/Dec time 3 3: Acc/Dec time 4 4: Acc/Dec time 5 5: Acc/Dec time 6 6: Acc/Dec time 7	1	000	○
F4.02	Section 1 run time	0~6000.0	0.1	10.0	○
F4.03	Section 2 setting	000~621	1	000	○
F4.04	Section 2 run time	0~6000.0	0.1	10.0	○
F4.05	Section 3 setting	000~621	1	000	○
F4.06	Section 3 run time	0~6000.0	0.1	10.0	○
F4.07	Section 4 setting	000~621	1	000	○
F4.08	Section 4 run time	0~6000.0	0.1	10.0	○
F4.09	Section 5 setting	000~621	1	000	○
F4.10	Section 5 run time	0~6000.0	0.1	10.0	○
F4.11	Section 6 setting	000~621	1	000	○
F4.12	Section 6 run time	0~6000.0	0.1	10.0	○
F4.13	Section 7 setting	000~621	1	000	○
F4.14	Section 7 run time	0~6000.0	0.1	10.0	○

F5-Terminal correlative function parameter group

Function code	Name	Set range	Min unit	Factory default	Modification
F5.00	Input terminal X1	0: Leave control terminal unused	1	0	×

Function parameter schedule graph

	function selection	1: Multi-step speed control terminal 1 2: Multi-step speed control terminal 2 3: Multi-step speed control terminal 3 4: Multi-step speed control terminal 4 5: External forward run jog control 6: External reverse run jog control 7: Accel / Decel time selecting terminal 1 8: Accel / Decel time selecting terminal 2 9: Accel / Decel time selecting terminal 3 10: External device failure input 11: External restoration input 12: Free stop input 13: External stop command 14: stop DC braking input command DB 15: Inverter run prohibition 16: Frequency increasing command(UP) 17: frequency descending command(DOWN) 18: Accel /Decel prohibited command 19: Three-wire run control 20: Closed-loop ineffective 21: PLC ineffective 22: Simple PLC pause command 23: PLC stop status restoration 24: Frequency provision channel selection 1 25: Frequency provision channel selection 2 26: Frequency provision channel selection 3 27: Frequency switched to CCI 28: Command switched to terminal 29: Run command channel selection 1 30: Run command channel selection 2 31: Run command channel selection 3 32: Traverse running 33: External interruption input 34: interior counter clearing end 35: interior counter triggering end 36: Interior timer clearing end 37: interior timer triggering end 38: Reserved 39: Reserved 40: forward running FWD terminal 41: reverse running REV terminal 42: Reserved			
F5.01	Input terminal X2 function selection	Same as F5.00			×
F5.02	Reserved				
F5.03	Reserved				
F5.04	Reserved				
F5.05	Reserved				
F5.06	Input terminal FWD function	Same as F5.00		40	×
F5.07	Input terminal REV function	Same as F5.00		41	×

Function parameter schedule graph

F5.08	FWD/REV operation mode selection	0: two-line control mode 1 1: two-line control mode 2 2: three-line control mode 1 3: three-line control mode 2	1	0	×
F5.09	UP/DOWN rate	0.01~99.99Hz/s	0.01 Hz/s	1.00 Hz/s	○
F5.10	Reserved				
F5.11	Reserved				
F5.12	Reserved				
F5.13	Reserved				
F5.14	Frequency reached (FAR)detection range	0.00~50.00Hz	0.01Hz	5.00Hz	○
F5.15	FDT1(frequency level)	0.00~upper limit frequency	0.01Hz	10.00Hz	○
F5.16	FDT1delay	0.00~50.00Hz	0.01Hz	1.00Hz	○
F5.17 ~ F5.24	Reserved				
F5.25	Set the internal calculation value to a given value	0~9999	1	0	○
F5.26	Set the internal calculation value to a given value	0~9999	1	0	○
F5.27	Internal timer timing setting	0.1~6000.0s	0.1	60.0	○

F6—Traverse special function parameter group

Function code	Name	Set range	Min unit	Factory default	modification
F6.00	Traverse function selection	0: Traverse function ineffective 1: Traverse function effective	1	0	×
F6.01	Traverse run mode	LED Units digit: traverse run mode 0: Automatic jump-in mode 1: Terminal manual run mode LED Tens digit: 0: Changing amplitude 1: Fixed amplitude LED Hundreds digit: Traverse halt start mode selection 0: Restart 1: Restart according to halt record LED Thousands digit: Traverse status save selection: 0: No save 1: Save Traverse center frequency input setting channel is set by F0.00 function.	1	0000	×
F6.02	Sudden jumping freq.	0.0~50.0(%)	0.1(%)	0.0(%)	○
F6.03	Sudden jumping freq.	0.0~50.0(%)	0.1(%)	0.0(%)	○
F6.04	Triangle wave rising time	0.1~999.9s	0.1s	10.0s	○

Function parameter schedule graph

F6.05	Triangle wave rising time	0.0~98(%) (Triangle wave rising time)	0.1(%)	50.0(%)	○
F6.06	Traverse preset frequency	0.00~400.00Hz	0.01Hz	0.00Hz	○
F6.07	Traverse preset frequency latency time	0.0~6000s	0.1s	0.0s	○

F7—Frequency provision function parameter group

Function code	Name	Set range	Min unit	Factory default	modification
F7.00 ~ F7.03	Reserved				
F7.04	CCI Minimum provision	0.00~F7.06	0.01V	0.00V	○
F7.05	Corresponding freq. to CCI minimum provision	0.00~Upper limit frequency	0.01 Hz	0.00Hz	○
F7.06	CCI max. provision	0.00~10.00V	0.01V	9.9V	○
F7.07	Corresponding freq. to CCI max. provision	0.00~Upper limit frequency	0.01 Hz	50.00Hz	○
F7.08 ~ F7.17	Reserved				

F8—Motor and vector control function parameter group

Function code	Name	Set range	Min unit	Factory default	modification
F8.00	Reserved				
F8.01	Motor rated voltage	1~999V	1V	Depend on device type	×
F8.02	Motor rated current	0.1~999.9A	0.1A	Depend on device type	×
F8.03	Motor rated frequency	1.00~400.0Hz	0.01Hz	Depend on device type	×
F8.04	Motor rated speed	1~9999r/min	1r/min	Depend on device type	×
F8.05	Motor pole	2~14	2	Depend on device type	×
F8.06	Motor rated power	0.1~999.9KW	0.1	Depend on device type	×
F8.07 ~ F08.17	Reserved				

F9—Protection function parameter

Function code	Name	Set range	Min unit	Factory default	modification
F9.00	Reserved				
F9.01	Failure self-restoration times	0~10 0 means: No self-restoration function. Noted: Self-restoration function is ineffective to failure protection caused by overload and over heat.	1	0	×
F9.02	Failure self-restoration	0.5~20.0S	0.1S	5.0S	×

Function parameter schedule graph

	interval				
F9.03	Motor overload protection mode selection	0: No action 1: Inverter cut off output at once	1	1	×
F9.04	Motor overload protection coefficient	20.0~120.0 (%)	0.1(%)	100.0 (%)	×
F9.05	Overload alarm checkout level	20~200 (%)	1(%)	130(%)	○
F9.06	Overload alarm delay time	0.0~20.0s	0.1s	5.0s	○
F9.07	Overvoltage stall selection	0: Banned 1: Allowed	1	1	×
F9.08	Stall overvoltage point	120~150 (%)	1(%)	140(%)	○
F9.09	Automatic current limiting level	110~200 (%)	1(%)	150(%)	×
F9.10	Frequency descending rate during current limiting	0.00~99.99Hz/s	0.01Hz /s	10.00Hz /s	○
F9.11	Automatic current limiting action selection	LED Units digit 0: Invalid 1: Valid LED Tens digit: Input loss phase detection 0: Invalid 1: Valid	1	00	×

Fd— Failure record function parameter

Function code	Name	Set range	Min unit	Factory default	modification
Fd.00	Previous one failure record	Previous one failure record	1	0	*
Fd.01	Previous two failure record	Previous two failure record	1	0	*
Fd.02	Previous three failure record	Previous three failure record	1	0	*
Fd.03	Previous four failure record	Previous four failure record	1	0	*
Fd.04	Previous five failure record	Previous five failure record	1	0	*
Fd.05	Previous six failure record	Previous six failure record	1	0	*
Fd.06	Set freq. at previous failure	Set freq. at previous failure	0.01Hz	0	*
Fd.07	Output freq. at previous failure	Output freq. at previous failure	0.01Hz	0	*
Fd.08	Output current at previous failure	Output current at previous failure	0.1A	0	*
Fd.09	Output volt. at previous failure	Output volt. at previous failure	1V	0	*
Fd.10	DC bus-bar vlot. at previous failure	DC bus-bar vlot. at previous failure	1V	0	*
Fd.11	Load motor speed at previous	Load motor speed at previous failure	1(r/m)	0	*
Fd.12	Module temp. at previous failure	Module temp. at previous failure	1℃	0	*
Fd.13	Input end state at previous failure	Input end state at previous failure		0	*
Fd.14	Accu. runtime at previous failure	Accu. runtime at previous failure		0	*

FF— Code and manufacturer function parameter

Function code	Name	Set range	Min unit	Factory default	modification
FF.00	User password	0000~9999	1	0000	×
FF.01	Manufacturer password	0000~9999	1	0000	×

Function parameter schedule graph

FF.02	Manufacturer special parameter				
FF.0X					

C—Monitoring function parameter group						
Function code	Name	Set range	Min unit	Factory default	modification	
C-00	Set frequency	Current set frequency	0.01HZ			
C-01	Output frequency	Current operating frequency	0.01HZ		*	
C-02	Output current	Set current effective value	0.1A		*	
C-03	Output voltage	Effective Value of Current Output Voltage	1V		*	
C-04	DC Bus Voltage	Current DC Bus Voltage	1V		*	
C-05	Load motor speed	Product of Output Frequency and Speed Correction Factor of Load Motor	1 (r/m)		*	
C-06	Module temperature	IGBT Radiator temperature	1°C		*	
C-07	Running time	Operating time of frequency converter on power	1h		*	
C-08	Cumulative running time	Accumulative running time of frequency converter	1h		*	
C-09	Input terminal status	Switch input terminal status	---		*	
C-10	Output terminal state	Switching output terminal state	---		*	
C-11	Reserved					
C-12	Analog input CCI	Analog input CCI value	V		*	
C-13	Reserved					
C-14	Reserved					

(1) The state correspondence of input terminals is as follows:

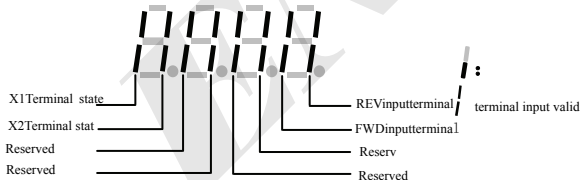

(2) The corresponding relations of output terminal states are as follows.:

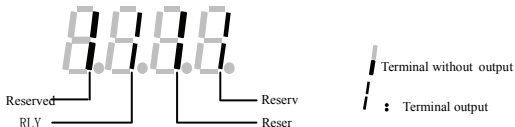

5 Trouble Shooting

5.1 Failure and countermeasure





Possible failure types in EDS300 are shown in Table 5-1 and failure code is from E001 to E023. Some failure code is reserved for intelligent automatic diagnosis function which will be executed continuously in future. When failure takes place in the inverter, the user should check according to note of this table first and record failure phenomena detailedly. Please contact our after-sale service and technical support Department or agent in your local place when technical service is needed.

Table 5-1 Failure Type and the Countermeasure

Failure code	Failure type	Possible reason	Countermeasure
E001	Over current during accelerating process	Accelerating time is too short	Prolong accelerating time
		Improper V/F curve	Adjust V/F curve setting, adjust manual torque boost or change to automatic torque boost
		Restart rotating motor	Set speed checking restart function
		Low power source voltage	Check input power supply
		Too small power of the inverter	Choose inverter with high-power
E002	Over current during decelerating process	Decelerating time is too short	Prolong decelerating time
		Have potential energy load or big inertia load	Increase braking power of external energy consumption braking subassembly
		Power of inverter is a bit small	Choose inverter with high-power
E003	Over current during constant speed process	Load change suddenly or Have unwonted phenomena	Check or reduce break of the load
		Accel / Decel time is set to too short	Prolong accelerating decelerating time properly
		low power source voltage	Check input power supply
		Power of inverter is a bit small	Choose inverter with high-power
E004	overvoltage during accelerating process	Unwonted input voltage	Check input power supply
		Accel time is set to too short	Prolong accelerating time properly
		Restart rotating motor	Set speed checking restart function
E005	overvoltage during decelerating process	Decelerating time is too short	Prolong decelerating time
		Have potential energy load or big inertia load	Increase braking power of external energy consumption braking subassembly
E006	Overvoltage during constant	Unwonted input voltage	Check input power supply
		Accel /Decel time is set to too short	Prolong accelerating decelerating time properly

Trouble shooting

	speed process	Input voltage change abnormally	Assemble reactor
		Load inertia is a bit big	Use energy consumption subassembly
E007	Control power supply overvoltage	Unwonted input voltage	Check input power supply or look for service
E008	Inverter overload	Accel time is set to too short	Prolong accelerating time
		DC injection braking is too big	Reduce DC injection braking current, Prolong braking time
		improper V/F curve	Adjust V/F curve and torque boost
		Restart rotating motor	Set speed checking restart function
		power source voltage is too low	check power source voltage
E009	Motor overload	Load is too big	Choose inverter with high-power
		improper V/F curve	Adjust V/F curve and torque boost
		power source voltage is too low	check power source voltage
		General motor run at low speed with big load	Can choose frequency conversion motor for long time low speed run
		motor overload protection factor set incorrectly	to set motor overload protection factor correctly
E010	Inverter over heating	motor blocked up or load change too suddenly and quickly	Check the load
		Air-path blocked	To clear air-path or improve ventilation condition
		Ambient temperature is too high	Improve ventilation condition, lower carrier frequency
E011	Reserved		
E012	Input missing phase	Fan damaged	Replace the fan
		Abnormal three-phase input power supply	Check whether the three-phase input power cord is falling off or not in good contact
		Abnormal power supply board	Look for service from manufacturer or agent
E013	Inverting module protection	Main control board abnormality	Look for service from manufacturer or agent
		Transient over current of the inverter	Refer to countermeasure for over current
		phase to phase short circuit or earthing short circuit of output 3 phase	wiring again
		Air-path blocked or fan damaged	To clear air-path or replace the fan
		Ambient temperature is too high	Lower ambient temperature
		Connecting wire or insert on	Check and connect the wire again

		control board loose	
		Unwanted current wave caused by missing output phase etc.	Check wiring
		Assistant power supply damaged and drive voltage lacking	Look for service from manufacturer or agent
		Unwanted control board	Look for service from manufacturer or agent
E014	External device failure	Use sudden stop  key in non-keypad run mode	Look up operation mode
		Use sudden stop  key under condition of stall	Set running parameter correctly
		Sudden stop terminal for external failure closed	Open external failure terminal after external failure is settled
E015	Current detecting circuit failure	Connecting wire or insert on control board loose	Look for service from manufacturer or agent
		Assistant power supply damaged	Look for service from manufacturer or agent
		Hall component damaged circuit	Look for service from manufacturer or agent
		Unwanted amplifying	Look for service from
E016	RS485 communication failure	Baud rate set improperly	set Baud rate properly
		Serial port communication error	press  key to reset, Look for service
		Failure warning	Modify F2.16, F2.17
		Upper device doesn't work	Check if upper device work and wiring is correct
E017	PID Disconnection fault	PID feedback amount lost	Check the PID feedback loop wiring is good or not good or not
		PID value instantly becomes	Check the equipment abnormal or
E018	reserved		
E019	Under voltage	Under voltage	check spot input voltage
E020	System disturbance	Serious disturbance	Reset by pressing  key or add mains filter at power supply input side
		Main control DSP read and write wrongly	Reset by the key-press, look for service
E021	Reserved		
E022	Reserved		
E023	E ² PROM read and write wrongly	Mistake take place when read or write control parameter	Reset by pressing  Look for service from manufacturer or agent
A-53	Operation Restriction Warning	Limit running time	Please contact your superior supplier.

P.OFF	Under voltage	Under voltage	check spot input voltage
-------	---------------	---------------	--------------------------

5.2 Failure record lookup

This series inverter can record the latest 6 times failure code and inverter run parameter of the last fault, to search these information can contribute to finding out fault cause.

Fault information is all stored in Fd group parameter, please enter into Fd group parameter to search information by referring to keypad operation method.

Code	Content	Code	Content
Fd.00	Previous 1 time fault record	Fd.08	Output current at previous 1 time fault
Fd.01	Previous 2 time fault record	Fd.09	Output volt. at previous 1 time fault
Fd.02	Previous 3 time fault record	Fd.10	DC bus-bar volt. at previous 1 time fault
Fd.03	Previous 4 time fault record	Fd.11	Load motor speed at previous 1 time fault
Fd.04	Previous 5 time fault record	Fd.12	Module temp. at previous 1 time fault
Fd.05	Previous 6 time fault record	Fd.13	Input terminal state at previous 1 time fault
Fd.06	Set freq. at previous 1 time fault	Fd.14	Accum. runtime at previous 1 time fault
Fd.07	Output freq. at previous 1 time fault		

5.3 Fault reset



- (1) Before reset you must find out fault cause downright and eliminate it, otherwise may cause permanent damage to the inverter..
- (2) Before reset you must find out fault cause downright and eliminate it, otherwise may cause permanent damage to the inverter.
- (3) Reset should be delay for 5 minutes after overload, overheat protection action.

To resume normal running when fault occur in the inverter, you can choose any kinds of operation as follows:

(1) Set any one terminal of X1~X2 to external RESET input (F5.00~F5.01=10), turn it off after connected to COM terminal.

(2) When fault code is displayed, Press  key after restoration is confirmed

(3) Cut off power supply.

6 Maintenance

6.1 Routine maintenance

When you use EDS300 series you must assemble and operate it according to demand listed in this 《service manual》 strictly. During run state, temperature, humidity, vibration, parts aging and wearing may affect it and potential fault occur. To avoid this, it is recommended to perform routine inspections and maintenance.

Table 6-1 Daily inspection items

Period		Inspection item	Inspection content	Criterion
Daily	Periodic			
√		Running status parameter	(1) Output current	(1) Within range of rated value
			(2) Output voltage	(2) Within range of rated value
			(3) Inside temp.	(3) Temp. increment < 35℃
√		Cooling system	(1) Installing ambient	(1) Good ventilation,unblocked air flue
			(2) local fan of inverter	(2) Rotate normally without abnormal noise
√		Motor	(1) Heating	(1) No abnormality
			(2) Noise	(2) Even
	√	Inverter	(1) Vibration, heating	(1) Vibration balanced, proper wind temp
			(2) Noise	(2) Without abnormal sound
			(3) Fixed lead and terminal	(3) Fixed screw no looseness
√		Running ambient	(1) Temperature, humidity	(1) -10℃~+40℃ 40℃~50℃used in derating or forced heat dissipation
			(2) Dust, water and leakage	(2) No water leakage imprint, no dust
			(3) Gas	(3) No peculiar smell

Recommend to inspect the inverter with following instruments:

Input voltage: electric voltmeter; Output voltage: rectifying voltmeter;
Input&output current: pincers ammeter.

6.2 Inspection and replacement of damageable parts

Some component parts in the inverter will be wearing or performance declining for long-term usage, to assure that the inverter can run stably and reliably, it is recommended to perform preventive maintenance and replace corresponding parts if necessary.

(1) Cooling fan

Abnormal noise, even oscillation sound may occur if the fan have wearing bearing, aging blade, here replacement of the fan should be considered.

(2) Filter electrolyte capacitance

When frequent load-changing causes pulsating current increasing and aging electrolyte under high ambient temperature, the electrolyte capacitance may be damaged and here should replace it.

6.3 Repair guarantee

(1) We provide free maintenance under warranty when any fault or damage occur under normal usage, warranty period can be seen in the warranty card, we will charge some when out of warranty.

(2) We will charge some upkeep if one of the following situations occurs under warranty.

① Do not use the inverter according to 《service manual》 strictly or do not use it under ambient demanded in 《service manual》, which cause fault.

② Fault caused by applying the inverter to non-normal function;

③ Fault caused by self-repair, refit which are not already allowed;

④ Damage caused by inappropriate storage, falling damage or other external factor after purchasing the inverter;

⑤ Fault caused by natural disaster or its reason such as abnormal voltage, thunderbolt, water fog, fire, salt corroding, gas corroding, earthquake and storm etc.;

⑥ Make bold to tear up product logo (such as: nameplate etc.); Serial number don't accord with warranty card.

(3) We charge service fee based on actual cost, which is subject to contract if any.

(4) You can contact with the agent or our company if you have any questions.



Machine which is out of warranty, we shall also provide lifetime charged maintenance service for it.

6.4 Storage

The user must pay attention to following points for temporary storage and long-term storage after purchasing the inverter:

(1) Avoid storing the inverter in place with high temperature, moist and dust, metal dust, make sure it is in good ventilation.

(2) Longtime storage will cause degradation of electrolyte capacitance, so must assure that it's electrified for one time within 2 years and electrification time is not less than 5 hours and input voltage must be increased to rated value gradually by voltage adjustor.

7 Modbus Communication Protocol

7.1 Summarization

We provide general RS485 communication interface in our inverters for the user. This interface can communicate with upper device (such as HMI, PC, PLC controller and etc.), To centralized monitoring to the inverter (such as to set inverter parameter, control inverter running, read working condition of the inverter).

This communication protocol is the interface normative file designed for realizing above-mentioned function, please read it earnestly and program according to it, so that realize remote and network control to the inverter.

7.2 Networking mode for communication networking

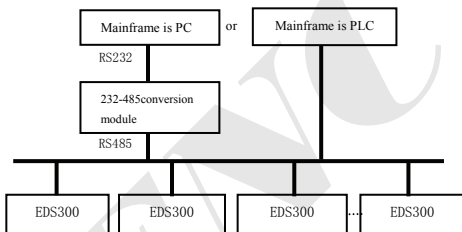

Fig.7-1 Networking mode diagram

7.3 Communication mode

At present, EDS300 inverter can be used only as slave in RS485 network. It Can realize communication between inverters through PC, PLC or HMI if it's needed. Specific communication mode as belows:

(1) PC or PLC as mainframe, Inverter as slave, point-to-point communication between main and slave device.

(2) Slave device don't response when mainframe send out command in broadcast address.

(3) User can set local address, Baud rate and data format of the inverter through keypad of slave device.

(4) EDS300 provides optional RS485 interface.

(5) Default mode: Asynchronous serial, semiduplex transport mode. RTU mode.

Default format and transport rate: 8-N-1, 9600bps.

7.4 RTU Communication Mode

7.4.1 Data frame format

Using RTU mode, messages are start to send in no less than 3.5 character time interval pause. The first field transmitted is device address, the character you can transfer is hexadecimal 0x00 ~ 0xFF. Network equipment Continuously monitor the bus, including pauses time. When the address field is received, all equipment determine whether it is sent to their own. when the last character of the packet transfer is completed, a no less than 3.5 character times pause mean the end of the message. A new message can begin after this pause.

The entire message frame must be transmitted as a continuous steaming transfer. If a new message start transmitting in less than 3.5 character times after previous one message, then the receiving device will consider it as a continuation of the previous one message. This will cause an error, because the final CRC field value cannot be right.

RTU frame format as the table below:

Frame Header	3.5 Characters time pause
Slave Address	Slave address: 1~127
Communication command code	03H: Read slave parameter 06H: Write slave parameter
Data content DATA	contents of message packet; Parameter address (16bit) ; Number of parameter or bytes of parameter value parameter value (16bit)
Data content DATA	
.....	
.....	
CRC check value low byte	16bit Unsigned check value
CRC check value high byte	
Closing Flag	3.5 characters time pause

Generation method of CRC check value, please refer to part 7.8 for verification mode.

7.4.2 Host read slave parameter

Command code 03H. Host can read one or more parameter (up to ten) by initiating a communication transaction.

E.g., read 2 contiguous inverter parameter values from the address 0000H of inverter whose address is 01, the contents of host command as follows:

ADR	01H
CMD	03H
Parameters initial address high byte	00H
Parameters initial address low byte	00H
Number of parameter high byte	00H
Number of parameter low byte	02H

CRC check value low byte	Be calculated
CRC check value high byte	Be calculated

The contents of slave answer package:

ADR	01H
CMD	03H
number of parameter value bytes	04H
Address 0000H content high byte	00H
Address 0000H content low byte	01H
Address 0001H content high byte	13H
Address 0001H content low byte	88H
CRC check value low byte	Be calculated
CRC check value high byte	Be calculated

7.4.3 Host write slave parameter

Command code 06H. Host can write an parameter by initiating a communication transaction .

E.g.,The decimal system 5000 (1388H) written to the inverter 0001H address whose slave address is 02, host command package including:

ADR	02H
CMD	06H
Parameter address high byte	00H
Parameter address low byte	01H
Parameter value high byte	13H
Parameter value low byte	88H
CRC check value low byte	Be calculated
CRC check value high byte	Be calculated

The contents of slave reply:

ADR	02H
CMD	06H
Parameter address high byte	00H
Parameter address low byte	01H
Address 0903H content high byte	13H
Address 0903H content low byte	88H
CRC check value low byte	Be calculated
CRC check value high byte	Be calculated

7.5 Data communication address allocation

7.5.1 Function code F0-Fd group communication address

The Addressing method of MODBUS communication address for inverter function code parameter follows PPnn mode: PP means address high byte, corresponding to function parameter's group number; nn means address low byte,

corresponding to function code parameter's group internal code. For example: F3.21 function code's communication address is 0315H, 03H is the hex form of group number 3, 15H is the hex form of group internal code 21.

F0.00~F9.11 communication address is 0000H~090BH, fault record parameter initial address of Fd group is 0D00H.

7.5.2 Control command and status word communication address

Variable Name	Communication address	Read-write property	Command data or response value meaning
Operating command word	2000H	Write only	1: Inching run
			2: Inching stop
			3: Forward inching run
			4: Reversal inching run
			5: Run
			6: Stop
			7: Forward run
			8: Reversal run
			9: Fault reset
			10: Emergency stop
Serial port frequency provision	2001H	Read- write	Lower limit frequency ~ upper limit frequency
Inverter status	2100H	Read only	1: Forwarder running
			2: Reversal running
			3: Stop
			4: Alarm status
Alarm code	2180H	Read only	0: No alarm 1 ~ 23: Mean E001~E023 alarm

7.5.3 Monitor parameter communication address

Monitor parameter	Name	Communication address (Read only)
C-00	Set frequency	1000H
C-01	Output frequency	1001H
C-02	Output current	1002H
C-03	Output voltage	1003H
C-04	DC bus-bar voltage	1004H
C-05	Load motor speed	1005H
C-06	Module temperature	1006H
C-07	Power on running time	1007H
C-08	Accumulative running time	1008H

C-09	Input terminal status	1009H
C-10	Output terminal status	100AH
C-11	Reserved	
C-12	Analog input CCI value	100CH
C-13	Reserved	
C-14	Reserved	

7.6 Communication error processing

Inverter receiving data packet detecting error, when it finds read-write parameter address or parameter value illegal, answer to the host with communication error answer packet. Communication error answer packet take (Host command code +80H) as command code, with 1 byte error code.

Format for communication error answer packet as follows:

ADR	01H
CMD	83H/86H
communication error code	01H-06H (for details, please check below table)
Low byte of CRC check value	Obtain by calculating
High byte of CRC check value	Obtain by calculating

Meaning for each communication error code value as follows:

Communication error code value	Type of communication error
0x01	CRC check error
0x02	Command code illegal
0x03	Register address visited illegal
0x04	Value to write register illegal
0x05	Not allow to modify parameter
0x06	number of read register illegal

7.7 Data frame examples

7.7.1 Start #1 inverter running

Data Field	slave Address	command code	Register address High byte	Register address low byte	Data High byte	Data Low byte	CRC low bit	CRC high bit
Host command frame	01	06	20	00	00	05	42	09
Slave respond frame	01	06	20	00	00	05	42	09

7.7.2 Stop 1# inverter running

Data Field	Slave Inverter Address	Command code	Register address High byte	Register address Low byte	Data High byte	Data Low byte	CRC low bit	CRC high bit
Host command frame	01	06	20	00	00	06	02	08
Slave respond frame	01	06	20	00	00	06	02	08

7.7.3 Set 1# inverter specified value to 50Hz

Data Field	Slave Inverter Address	Command code	Register address High byte	Register address Low byte	Data High byte	Data Low byte	CRC Low bit	CRC High bit
Host command frame	01	06	20	01	13	88	DE	9C
Slave respond frame	01	06	20	01	13	88	DE	9C

7.7.4 Read 1# inverter running state

Data Field	slave Inverter Address	Command code	Register address High byte	Register address Low byte	Data High byte	Data Low byte	CRC low bit	CRC high bit
Host command frame	01	03	21	00	00	01	8E	36
Slave respond frame	01	03	(Number of respond value bytes) 02		00	00	B8	44

7.8 CRC check mode

CRC checksum value calculating function written by C language is as follows:

```
unsigned int cal_crc_value (unsigned char *pval, unsigned char len)
{
    unsigned int crc_value=0xFFFF;
    unsigned int i;

    while(len--)
    {
        crc_value ^= *pval++;
        for(i=0; i<8; i++)
        {
            if(crc_value & 0x0001)
            {
                crc_value >>= 1;
                crc_value ^= 0xA001;
            }
            else
            {
                crc_value >>= 1;
            }
        }
    }
    return(crc_value);
}
```

Appendix A Serial port 485 communication protocol

A.1 Summarization

We provide general RS485/RS232 communication interface in our Inverters for the user. Through this communication interface upper device (such as PC, PLC controller etc.) can perform centralized monitor to the inverter (such as to set inverter parameter, control run of inverter, read work state of the inverter) and also long-distance control keypad can be connected to realize various usage requirement of the user.

This communication protocol is interface criterion file designed for realizing above-mentioned function, please read it earnestly and program according to it so that realize long-distance and network control to the inverter.

A.2 Protocol content and description

A.2.1 Communication net buildup mode

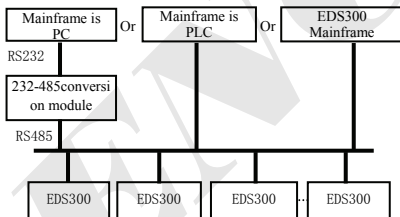

Fig.A-1 Net Buildup Graph

A.2.2 Communication mode

At present, EDS300 inverter can be used only as auxiliary device in 485 net. Can realize communication between inverters through PC or PLC if it's needed. Specific communication mode is as mentioned below:

- (1) PC or PLC as mainframe, inverter as auxiliary device, point-to-point communication between mainframe and auxiliary device.
- (2) Auxiliary device don't response when mainframe send out command by broadcast address.
- (3) User can set local address, baud rate and data format of the inverter through auxiliary device keypad or serial communication mode.
- (4) Auxiliary device report current failure information to mainframe in the last response frame.
- (5) EDS300 provides 485 interface.

A.2.3 Transport mode

Asynchronous serial, semiduplex transport mode. Default format and transport rate: 8-N-1, 9600bps. For specific parameter setting please see description for F2.14~F2.17 group function code.

(Remark: Below definition is only effective under series port RS485 communication mode, and definition for other parameters are the same as original)

F2.14	Communication configuration	LED first bit: baud rate selection 0: 1200BPS 1: 2400BPS 3: 9600BPS 4: 19200BPS 5: 38400BPS LED second bit: data format 0: 1-8-1 Format, no checkout 1: 1-8-1 Format, even checkout 2: 1-8-1 Format, odd checkout	1	03	×
F2.15	Local address	0-127, 127 is a broadcast address	1	1	×
F2.16	Communication timeout detection time	0.0~1000.0s	0.1s	0.0s	×
F2.17	Local response delay	0~200ms	1ms	5ms	×

A.2.4 Data command frame format

Main device command frame format																		
Sending order	1	2	3	4	5	6	7	8	9	10	11	12	13	14	15	16	17	18
	Frame head	Auxiliary device address	Auxiliary device address	Main device command	Main device command	Assistant index	Assistant index	Command index	Command index	Set data	Set data	Set data	Set data	Checkout sum	Checkout sum	Checkout sum	Checkout sum	Frame end
Definition	head	address		Command area		Index area		Setting data area				Checkout area				End		
Sending byte	1	2		2		4		4				4				1		
Auxiliary device response frame format																		
Sending order	1	2	3	4	5	6	7	8	9	10	11	12	13	14	15	16	17	18

13	Get ready	Don't allow	Don't allow
14	Get ready	Don't allow	Don't allow
20	Frame error		

Species 2>: command code="11"~"15", 5 kinds of function command which mainframe send to auxiliary device, for detail please see protocol command list.

Table A-2 Response code meanings for command code "11~15"

Response code ASCII	Meaning of response code	description
00	Auxiliary device communication and control is normal: function code password is correct	
20	(1) Frame checkout error; (2) "command area" data overrun; (3) "index area" data overrun (4) Frame length error/non ASCII byte exist in area except frame head, frame end.	When this response code is reported, date of "command area", "index area" and "running data area" are not reported.
30	(1) control to auxiliary device is ineffective; (2) ineffective function code parameter modification; (3) "setting/running data area" data overrun; (4) Password error	Whether report this response code relate to current set state of auxiliary device. When report date of area, "index area" and "run date area" are reported according to protocol requirement.

(4) Auxiliary index/command index/failure index

Data meanings: include auxiliary index byte and command index byte.

For mainframe, auxiliary index, command index are used for cooperating mainframe command in realizing specific function.

For auxiliary device, auxiliary index, command index are used for reporting failure state code, command index are reported without modification.

Data type: hex, 4 byte, ASCII format.

Command index occupy 2 low byte, data range: "00"~"FF".

Auxiliary index occupy 2 high byte, data range: "00"~"FF".

Auxiliary device failure state occupy "auxiliary index" byte, see Appendix table

3.

Table A-3 Failure type description

Failure code	Description	Failure code	Description
1	Accelerating run over current	13	Converting module protection
2	Decelerating run over current	14	External device failure
3	Constant speed run over current	15	Current detecting circuit failure
4	Accelerating run over voltage	16	RS485 communication failure

Appendix A Serial port 485 communication protocol

5	Decelerating run over voltage	17	reserved
6	Constant speed run over voltage	18	reserved
7	Controller power supply over voltage	19	Under voltage
8	Inverter overload	20	System disturbance
9	Motor overload	21	reserved
10	Inverter over heat	22	reserved
11	reserved	23	E ² PROM read and write error
12	reserved		

(5) Checkout sum

Data meanings: frame checkout, 4 byte, ASCII.

Calculation method: accumulative sum of ASCII code value of all byte from“auxiliary device address”to“run data”.

(6) Frame end

Hex 0D, Single byte.

A.2.6 Protocol command list

Frame 7E and frame end 0D, address, checkout sum, ASCII character format are omitted in following description.

Table A-4 Protocol Command Table

Name	Main frame order	Auxiliary index	Order index	Run data setting range	Main frame sending example, such as PC control operation of inverter (C language cluster format, auxiliary device address is set to 01	Run data precision	description
Look up auxiliary motor state	10	00	00	No	-010A00000192/r	1	
Read parameter of auxiliary motor	Current set freq.	11	00	00	No	-010B00000193/r	0.01Hz
	Current set freq.	11	00	01	No	-010B00010194/r	0.01Hz
	Output voltage	11	00	02	No	-010B00020195/r	1V
	Output current	11	00	03	No	-010B00030196/r	0.1A
	Bus-bar voltage	11	00	04	No	-010B00040197/r	1V
	Load motor speed	11	00	05	No	-010B00050198/r	1Rmp
	Module temp	11	00	06	No	-010B00060199/r	1℃
	Runtime	11	00	07	No	-010B0007019A/r	1h
	Accumulative time	11	00	08	No	-010B0008019B/r	1h
	Input terminal	11	00	09	No	-010B0009019C/r	no
	Output terminal	11	00	0A	No	-010B000A019A/r	no
Analog input CCI	11	00	0B	No	-010B000C019A6/r	0.01V	

Appendix A Serial port 485 communication protocol

	Read inverter state	11	00	0F	No	-010B000F01A9/r	no	
Read function code parameter	Auxiliary device run command	12	00	00	No	-010C00000194/r	no	
	Set current run frequency provision of	12	00	01	No	-010C00010FA0027C/r	0.01Hz	Set freq.=40.00Hz
	Auxiliary device run with run freq. provision	12	00	02	0Hz-high limit freq.	-010C00020FA0027D/r	0.01Hz	Auxiliary device run Set freq.=40.00Hz
	Auxiliary device forward run	12	00	03	0Hz-high limit freq.	-010C00030197/r	no	
	Auxiliary device reverse run	12	00	04	No	-010C00040198/r	no	
	Auxiliary device forward run with run freq.provision	12	00	05	0Hz-high limit freq.	-010C00050FA00280/r	0.01Hz	forward run boot-strap set freq.=40.00Hz
	Auxiliary device reverse run with run freq.provision	12	00	06	0Hz-high limit freq.	-010C00060FA00281/r	0.01Hz	reverse run boot-strap set freq.=40.00Hz
	Auxiliary device stop	12	00	07	No	-010C0007019B/r	no	
	Auxiliary device jog run	12	00	08	No	-010C0008019C/r	no	
	Auxiliary device forward jog run	12	00	09	No	-010C0009019D/r	no	
	Auxiliary device reverse jog run	12	00	0A	No	-010C000A01A5/r	no	
	Auxiliary device stop jog run	12	00	0B	No	-010C000B01A6/r	no	
	Auxiliary device failure restoration	12	00	0C	No	-010C000C01A7/r	no	
	Auxiliary device urgent stop	12	00	0D	No	-010C000E01A8/r	no	
Read function code parameter	Run freq. digital setting F0.01	13	00	01	No	~010D00010196/r	0.01Hz	
	Run direction setting F0.03	13	00	03	No	~010D00030198/r	1	
	Accelerating time1	13	00	0A	No	~010D000E01AA/r	0.1S	
	F0.08 decelerating time1 F0.09	13	00	0B	No	~010D000F01AB/r	0.1S	
Set function code parameter	Run freq. digital setting F0.01	14	00	01	0Hz~High limit Freq.	~010E00011388026B/r	0.01Hz	Set function code F0.01=50.00Hz
	Run direction Setting F0.03	14	00	03	0, 1	~010E00030001025A/r	1	Set function code F0.03 to reverse

Appendix A Serial port 485 communication protocol

Software version query order	Accelerating time1 F0.08	14	00	09	0~8CA0	~010E000E03E8028B\r	0.1S	run Set function code F0.08 to 10.0s
	Decelerating time1 F0.09	14	00	0A	0~8CA0	~010E000F03E8028C\r	0.1S	Set function code F0.09 to 10.0s
	Query auxiliary device software version	15	00	00	No	~010F00000197\r	1	

Table A- 5 Response state word meanings of reading inverter state command

Bit	Signification		
	Description	0	1
Bit0	Stop/run state	Stop	Run
Bit1	Logo for under voltage	Normal	Under voltage
Bit2	FWD/REV run logo	Forward run	Reverse run
Bit3	Traverse run mode logo	Ineffective	Effective
Bit4	Common run mode logo	Ineffective	Effective
Bit5	Jog run mode logo	No	Jog
Bit6	PLC run mode logo	No	Yes
Bit7	Multi-step freq. run mode logo	No	Yes
Bit8	PI closed loop run mode logo	No	Yes
Bit9	Set counting value arriving logo	No	Yes
Bit10	Specified counting value arriving logo	No	Yes
Bit11~15	Reserved		

Table A-6 Read auxiliary device function code parameter

Function definition	Read auxiliary device function code parameter: all function code parameter except user password and manufacturer password						
Meanings	Frame head	Address	Order	Order index	Run data	Checksum sum	Frame end
Mainframe order	7EH	ADDR	13	See remark	none	BCC	0DH
Byte quantity	1	2	2	4	0	4	1
Auxiliary device respond	7EH	ADDR	06	See remark	Function code para	BCC	0DH
Byte quantity	1	2	2	4	4	4	1
Remark	Command index=combined by function code group number and hex code of function code number. For instance: If want to read parameter of F0.05 function code, order index=000B;						

	If want to read parameter of F2.11 function code, order index=020B; If want to read parameter of F2.15 function code, order index=0212; If want to read parameter of F2.13 function code, order index=0210;					
	Function group	Decimal	Hex	Function group	decimal	Hex
	F0	0	00H	F6	6	06H
	F1	1	01H	F7	7	07H
	F2	2	02H	F8	8	08H
	F3	3	03H	F9	9	09H
	F4	4	04H	FD	13	0DH
F5	5	05H	FF	15	0FH	
Virtual data	0-FFFF (N amely 0-65535)					

Please input correct “user password” before you set user function code parameter.

Table A-7 Set auxiliary device function code parameter

Function definition	Read auxiliary device function code parameter: all function code parameter except user password and manufacturer password						
Meanings	Frame head	Address	Order	Order index	Run data	Checkout sum	Frame end
Mainframe order	7EH	ADDR	13	See remark	none	BCC	0DH
Byte quantity	1	2	2	4	0	4	1
Auxiliary device respond	7EH	ADDR	06	See remark	Function code para	BCC	0DH
Byte quantity	1	2	2	4	4	4	1
	Command index=combined by function code group number and hex code of function code number. For instance: If want to read parameter of F0.05 function code, order index=000B; If want to read parameter of F2.11 function code, order index=020B; If want to read parameter of F2.15 function code, order index=0212; If want to read parameter of F2.13 function code, order index=0210;						
	Function group	decimal	hex	Function group	decimal	hex	
	F0	0	00H	F6	6	06H	
	F1	1	01H	F7	7	07H	
	F2	2	02H	F8	8	08H	
	F3	3	03H	F9	9	09H	
	F4	4	04H	FD	13	0DH	
F5	5	05H	FF	15	0FH		
Virtual data	0-FFFF(n amely 0-65535)						

Appendix B Braking Resistance

B.1 Braking resistance

The motor's electric potential energy will charge inverter's capacitance up reversely if speed of the motor decends too quickly or load of the motor wobbles too quickly while the inverter is running, which will increase the voltage upon power modules suddenly and is easy to make the inverter damaged. The inverter will control it according to load size and performance. You have to connect external resistance to realize timely energy discharge when the braking is not enough. To connect external resistance is a kind of energy consumption braking mode, As all the energy is consumed by the braking resistance.

EDS300 series' the built-in braking unit is optional and you can add external braking resistance , But the external resistance need booking.

External braking resistance configuration table

Type	Built-in braking unit	Braking resistance	Qty	Power of braking resistance	Remark
EDS300-2S0002	Built-in	500Ω	1PCS	60W	External braking resistance
EDS300-2S0004	Built-in	500Ω	1PCS	60W	External braking resistance
EDS300-2S0007	Built-in	500Ω	1PCS	60W	External braking resistance
EDS300-2S0015	Optional	500Ω	1PCS	60W	External braking resistance
EDS300-2S0022	Built-in	300Ω	1PCS	1KW	External braking resistance
EDS300-4T0007	Built-in	800Ω	1PCS	60W	External braking resistance
EDS300-4T0015	Optional	800Ω	1PCS	60W	External braking resistance
EDS300-4T0022	Optional	300Ω	1PCS	1KW	External braking resistance
EDS300-4T0037	Built-in	125Ω	1PCS	2KW	External braking resistance



ENC Shenzhen Encom Electric Technologies CO., LTD.

Address: 5F, Bldg.4, Minqi Technology Park, Lishan Rd.,
Nanshan Area, Shenzhen 518055, China

Website: www.encvfd.com

E-mail: encvfd@encvfd.com
encvfd@enc.net.cn

Tel: +86-755-26984485

Fax: +86-755-26985120