

Stepping System DP3CL / DP3C / DP3L / DP3F

Excellent performance • Stable and reliable



XINJE

WUXI XINJE ELECTRIC CO.,LTD.

Address: No.816,Jianzhu West Road,Binhu District,Wuxi City,Jiangsu Province,China

TEL: 86-0510-85134136

Fax: 86-0510-85111290

Website: www.xinje.com

Email: sales@xinje.com

Technical Service Hotline
400-885-0136

XINJE Wechat

Industrial automation trusted partner

Bus Type stepping driver

DP3C Closed-loop Bus Stepping Driver

- Integrating EtherCAT bus technology
- Fast response
- Strong anti-interference ability
- Significantly improved performance



DP3CL Open Loop Bus Stepping Driver

- Excellent value
- Low cost while retaining the high performance and stability of DP3C



1 Integrating EtherCAT bus technology, the communication is faster

Support COE (CANopen over EtherCAT) protocol, conform to the CiA402 standard and support 32 axes. Support the master station with standard EtherCAT protocol. The communication cycle between the master station and the slave station can reach 32 axes 1ms at most.

3 Simple wiring and convenient equipment maintenance

A network cable replaces the traditional pulse direction signal cable, and is equipped with power cable and encoder cable, making the wiring simpler. It can greatly reduce the cable cost, labor cost and maintenance cost.



4 Higher reliability and anti-interference

Relying on the low bus load and point-to-point physical layer of EtherCAT bus, it can greatly suppress the generation of interference and clutter, and significantly improve the reliability and anti-interference ability of the system.

2 A new generation of control algorithm with better performance

EtherCAT bus technology combined with the latest control algorithm, greatly improves the performance

The torque is increased, which significantly improves the high-speed performance of the motor, up to 2000rpm.

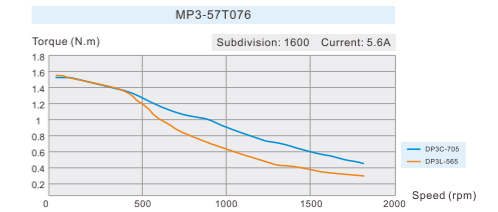

The motor runs more smoothly and the temperature rising is significantly reduced

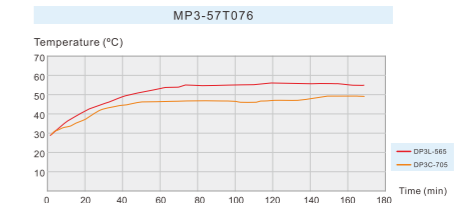

Application Scenario

DP3C, DP3CL series bus stepping driver

It is suitable for electronics, laser and occasions requiring multi-axis control.

- 01 Stripping machine
- 02 Marking machine
- 03 Graph plotter
- 04 Medical equipment
- 05 Electronic processing equipment
- 06 Engraving machine
- 07 Laser machine
- 08 Cutting machine
- 09 Numerical control machine
- 10 Automatic assembly equipment



Graph plotter



Filling machine

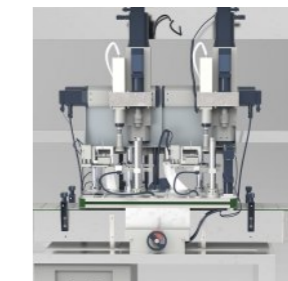

Capping machine



Mask machine

Hardware Interface

DP3C series

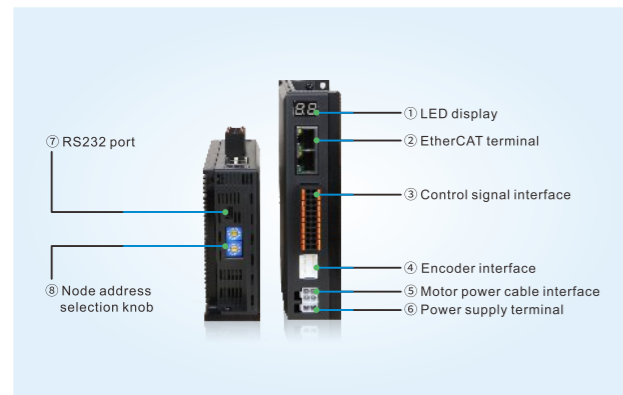

① LED display status

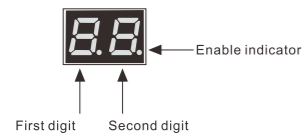

DP3C series displays operation speed, state machine/operation mode, node address, alarm fault and other information through two digits LED.

Stage	Display information
Power on initial stage	After the driver is powered on, the two LEDs are on for 0.5s, and display the actual node address of the current driver in hexadecimal. During this period, the LED node address flashes at an interval of 1s (0.5s on and 0.5s off). The time is 5s in total. After that, it enters the normal operation stage
Normal operation stage (parameter modification display content)	Speed (r/s)
	Operation mode, state machine: hexadecimal display (default) Node address: always on display

*Note: during initialization and normal operation, if the node address is changed, the LED flashes at an interval of 1s (0.5s on, 0.5s off), and then continues to return to the original state after 5s.

② EtherCAT terminal

Signal	Explanation
E_TX+	EtherCAT data send +
E_TX-	EtherCAT data send -
E_RX+	EtherCAT data receive +
E_RX-	EtherCAT data receive -

*Note: The cable length between EtherCAT bus nodes is recommended to be no more than 50m. It is recommended to use CAT5e 100M Ethernet cable with double-layer shielding layer or better.

③ Control signal interface

Signal	Explanation
SI1+	Differential input signal SI1, 24V is effective, max input frequency 200KHz, default probe input signal 1
SI1-	
SI2+	Differential input signal SI2, 24V is effective, max input frequency 200KHz, default probe input signal 2
SI2-	
SI3	
SI6	Single ended input signal SI3-SI7, 12-24V is effective, max input frequency 10KHz, signal definition can be set. I3 default is origin point, I4, I5 default are positive/negative limit, I6, I7 default is general purpose. COMI is common terminal of single ended signal input, common anode or common cathode
SI4	
SI7	
SI5	
COMI	
SO1+	Differential output signal OUT1, output max current 100mA, withstand voltage 30VDC, default is alarm output
SO1-	
SO2+	Differential output signal OUT2, output max current 100mA, withstand voltage 30VDC, default is in place signal
SO2-	
SO3	
SO6	Single ended output, common cathode, max current 100mA, withstand voltage 30VDC
SO4	
24V	Used together with braking output
SO5	Single ended output, common cathode, max current 100mA, withstand voltage 30VDC
BRK+	Braking output +, max 500mA, withstand voltage 24V, can connect the brake directly without connecting the relay
BRK-	Braking output -, max 500mA, withstand voltage 24V, can connect the brake directly without connecting the relay
COMO	Common terminal of the output common cathode

⑤ Motor winding terminal

Signal	Explanation
A+	Motor winding phase A +
B+	Motor winding phase B +
A-	Motor winding phase A -
B-	Motor winding phase B -

*Note: XINJE's standard power cable diameter is 0.75mm².

④ Encoder signal input terminal

Signal	Explanation
PE	Shielding ground
NC	Reserved signal
NC	
NC	
VCC	5V power supply output, provided by the driver, only for encoder power supply
GND	
EZ+	Encoder phase Z signal +
EZ-	Encoder phase Z signal -
EB+	Encoder phase B signal +
EB-	Encoder phase B signal -
EA+	Encoder phase A signal +
EA-	Encoder phase A signal -

*Note: The standard configuration is without Z signal. If Z phase homing is required, the motor and encoder cables supporting Z signal shall be selected.

⑥ Power supply terminal

Signal	Explanation
GND	Power supply ground
VDC	Power supply positive input

*Note: XINJE's standard power cable diameter is 0.75mm².

⑦ Upper computer communication RS232 port

Signal	Explanation
TXD	RS232 send
RXD	RS232 receive
GND	RS232 ground

*Note: Please use the special cable provided by XINJE company for communication. RS232 default communication parameters: baud rate 115200bps, data bit 8, stop bit 1, even parity, station NO. 1.

⑧ Node address selection knob

The node address can be set through the combination of two hexadecimal rotary dialing codes MSD (high bit) and LSD (low bit).

DP3CL series

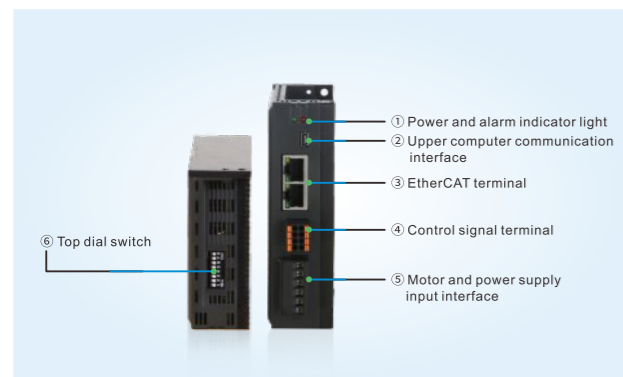

① Power and alarm indicator light

Color	Function
Green light	Power supply display PWR
Red light	Fault alarm indicator

Flashing message	Fault explanation
Flash once	Over current or short circuit
Flash continuously twice	Over voltage
Flash continuously 3 times	Under voltage
Flash continuously 4 times	Open circuit or poor contact of moto
Always on	Bus related alarm

*Note: When a fault occurs, the indicator light flashes continuously, pauses for one second and then flashes continuously.

② Upper computer communication RS232 port

Signal	Explanation
TXD	RS232 send
RXD	RS232 receive
GND	RS232 ground

*Note: Please use the special cable provided by XINJE company for communication. RS232 default communication parameters: baud rate 115200bps, data bit 8, stop bit 1, even parity, station NO. 1.

③ EtherCAT terminal

Signal	Explanation
E_TX+	EtherCAT data send +
E_TX-	EtherCAT data send -
E_RX+	EtherCAT data receive +
E_RX-	EtherCAT data receive -

*Note: The cable length between EtherCAT bus nodes is recommended to be no more than 50m. It is recommended to use CAT5e 100M Ethernet cable with double-layer shielding layer or better.

⑤ Motor and power supply input interface

Interface	Function
A+ / A-	Motor phase A
B+ / B-	Motor phase B
GND	DC power supply ground
+V	DC power supply +

④ Control signal terminal

Signal	Explanation
SI1	
SI2	Single ended input signal SI1-SI4, 24V is effective, max pulse frequency 10KHz, the signal definition can be set. SI1, SI2, SI3, SI4 default is alarm clear, left/right limit and origin point. COMI is single ended input signal common terminal, supports NPN and PNP
SI3	
SI4	
COMI	
COMO	Output common terminal COM
ERR	Alarm output, max 50mA, withstand voltage 24V
BRK	Braking output, max 500mA, withstand voltage 24V, can connect the brake directly without connecting the relay

⑥ Top dial switch

Dial number	Explanation
SW1, SW2, SW3	Dynamic current setting
SW4	Half current/full current mode
SW5, SW6	Filter time
SW7	Direction
SW8	Station switching

Driver Peripheral Circuit

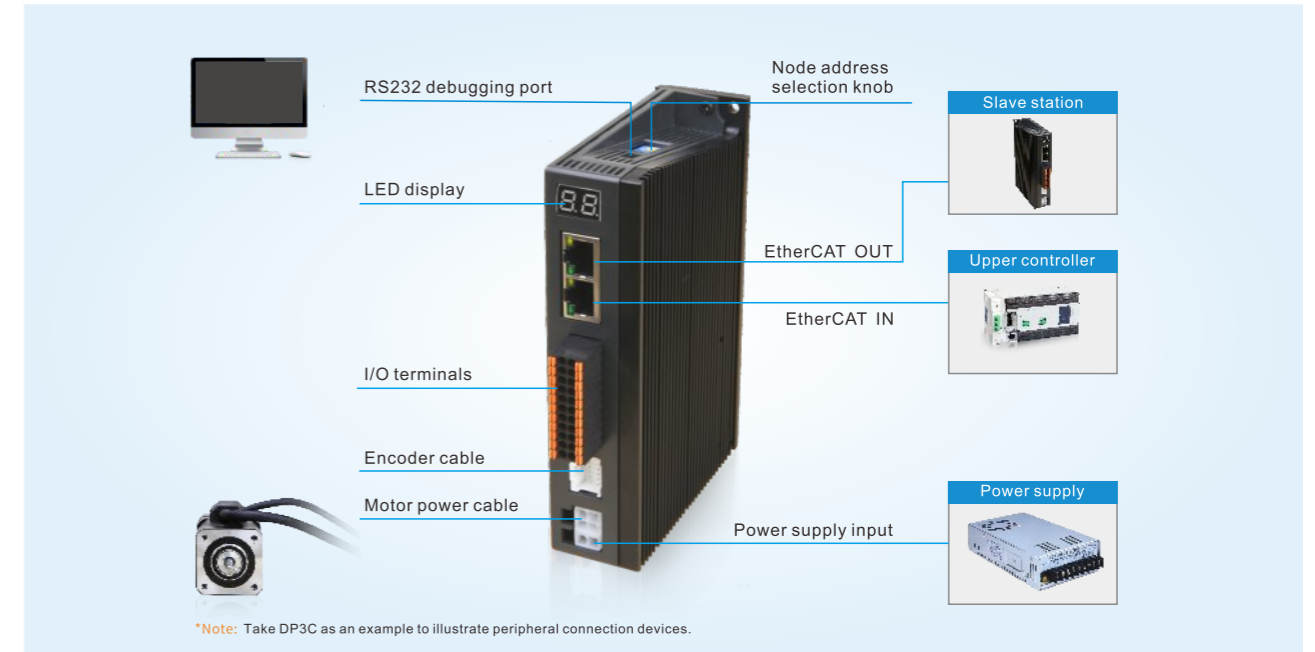

*Note: Take DP3C as an example to illustrate peripheral connection devices.

Driver Wiring Diagram

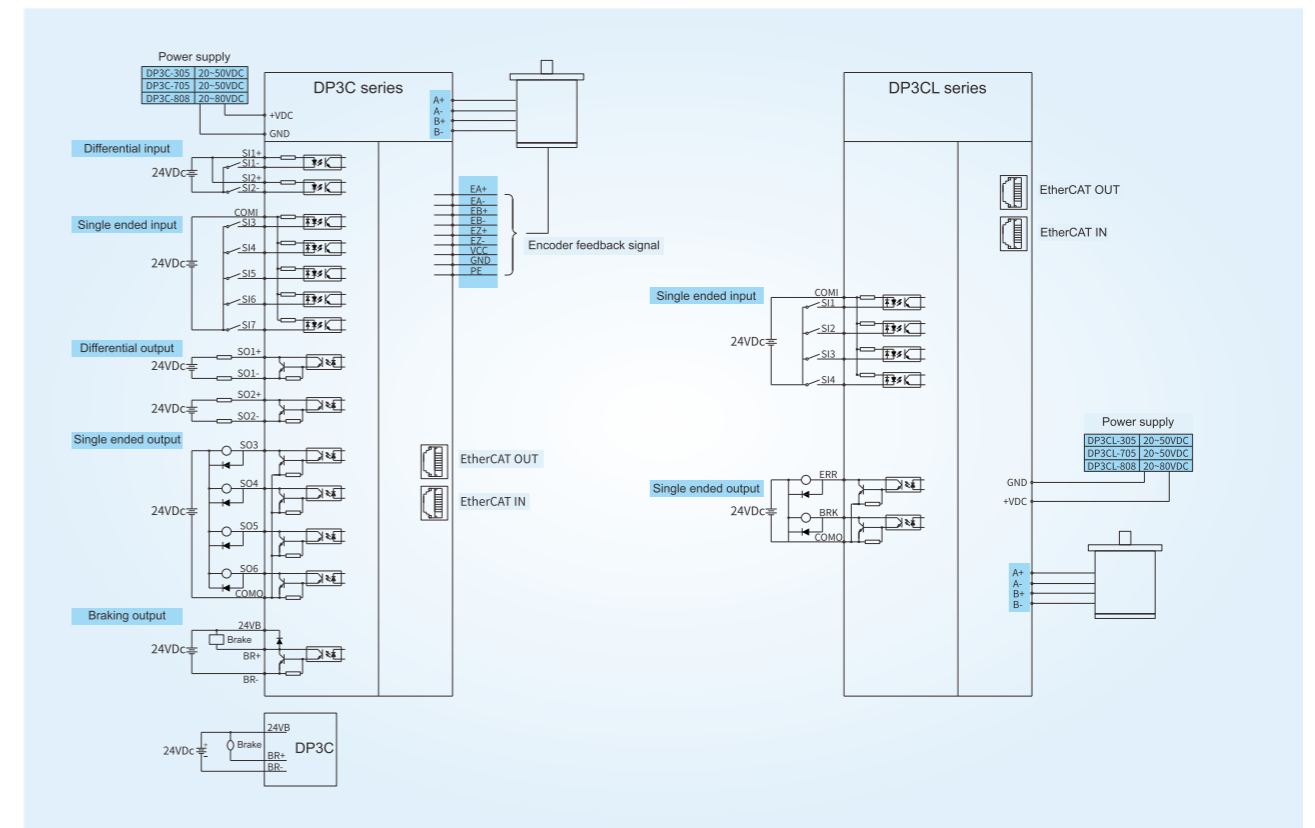

Product Model

Driver model naming

DP3 C L - 70 5

① ② ③ ④ ⑤

① Name		② Series		③ Control type		④ Driver output peak current		⑤ Driver max power supply voltage	
Sign	Product name	Sign	Product series	Sign	Current	Sign	Current	Sign	Voltage
DP3	Stepping driver	C	Bus type	L	Open loop control	30	3.0A	5	50V
				No	Closed-loop control	70	7.0A	8	80V
						80	8.4A		

Driver Specification

Driver model	DP3C-305	DP3C-705	DP3C-808	DP3CL-305	DP3CL-705	DP3CL-808
Input power supply voltage (VDC)	20~50	20~50	20~80	20~50	20~50	20~80
Recommended power supply voltage (VDC)	24~36	57 motor recommended 24~36, 86 or high-speed motor recommend 48V	Above 48V	24~36	57 motor recommended 24~36, 86 or high-speed motor recommend 48V	Above 48V
Output current peak (A)	1~3	1~7	1~8.4	1~3	1~7	1~8.4
Adaptive motor (base)	42	57/60	86	42	57/60	86
External dimension (mm)	97.2*145.0*35.5			92.2*125.0*35.5		
Input signal	Probe input, origin input, positive and negative limit, emergency stop, user-defined input			Origin input, positive/negative limit, alarm clear, user-defined input		
Output signal	Alarm output, in place output, brake signal output, user-defined output			Alarm output, brake signal output, user-defined output		
Alarm function	Over current, over voltage, out of tolerance, communication error, etc					
Debugging software	XINJE stepping driver software					
Using environment	Use occasion	Try to avoid dust, oil mist and corrosive gas. Combustible gas and conductive dust are prohibited in places with high humidity and strong vibration				
	Ambient temperature	0°C~50°C				
	Max working temperature	60°C				
	Humidity	40%~90%RH (no condensation or water droplets)				
	Vibration	5.9m/s ² Max				
Storage temperature	-20°C~65°C					

Driver Dimension

(Unit: mm)

DP3C-305, DP3C-705, DP3C-808

DP3CL-305, DP3CL-705, DP3CL-808

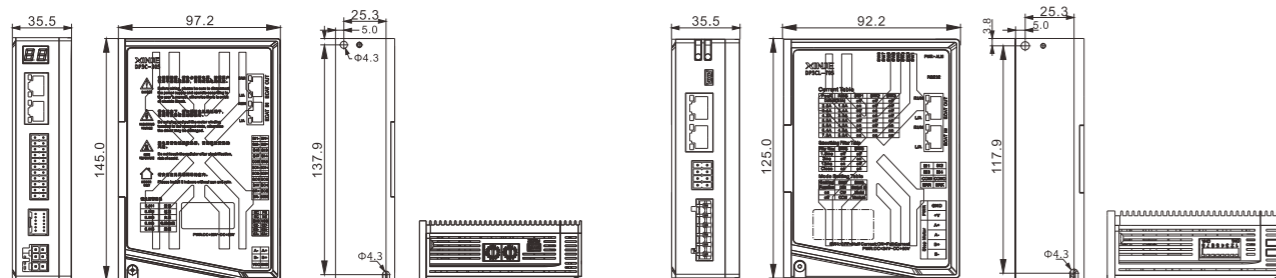

Accessories

Encoder cable

CNA side	1	2	3	11	12	13
Color	Blue	Yellow	Yellow black	Green	Green black	Blue black
Definition	A+	VCC	GND	B+	B-	A-
CNB side	11	5	6	9	10	12

Model	Length L (m)
CP-MD-2	2
CP-MD-3	3
CP-MD-5	5
CP-MD-8	8
CP-MD-10	10
CP-MD-12	12
CP-MD-16	16

*Note: If Z signal output is required, please use encoder cable [CP-MD-Z-length].

Power cable

A end PIN	1	2	3	4
Definition	B+	A+	A-	B-
Color	Black	Brown	Blue	Yellow green
B end PIN	2	1	3	4

Model	Length L (m)
CM-MP07-2	2
CM-MP07-3	3
CM-MP07-5	5
CM-MP07-8	8
CM-MP07-10	10
CM-MP07-12	12
CM-MP07-16	16

*Note: For customers who want to make cable by themselves, they can choose JAMP-M4-P4 accessory package, which contains the terminals of driver and motor, and can press the cables by themselves. If you need this bus driver with open-loop motor, please choose JAMP-M4 accessories, including the driver terminal, which can press the cable by yourself.

EtherCAT bus cable

Model	Length (m)
JC-CB-0P1	0.1
JC-CB-0P2	0.2
JC-CB-0P3	0.3
JC-CB-0P5	0.5
JC-CB-1	1
JC-CB-3	3
JC-CB-5	5
JC-CB-10	10
JC-CB-20	20

Power supply cable

Each driver will be delivered with a power cable for free. For additional needs, the purchase models are as follows:

Model	Length (m)
JC-PM-20	2

Pulse Type stepping driver

DP3F Closed-loop Pulse Stepping Driver

- Closed loop control and torque lifting to prevent step loss
- Higher running speed and acceleration
- More stable operation at low speed
- The plug-in wiring is simple and fast
- Pulse and direction input voltage support 5V and 24V
- Comprehensive overvoltage, overcurrent, undervoltage and short circuit protection functions

Applicable occasions: various small and medium-sized automation equipment and instruments, such as engraving machine, stripping machine, cutting machine, etc.



DP3L Open Loop Pulse Stepping Driver

- Smaller size and space saving
- Torque increase and temperature rise decrease
- Perfect protection function and alarm mechanism

Applicable occasions: all kinds of small and medium-sized automation equipment and instruments, such as labeling machine, word cutting machine, pneumatic marking machine, etc.



DP3L High Voltage Open Loop Pulse Stepping Driver

- Supply voltage 220~240VAC
- Pulse and direction input voltage support 5V and 24V
- New control algorithm, significantly improved performance
The medium and high speed torque is 10 ~ 30% higher than the original product

Applicable occasions: slicer, clothing packer



Hardware Interface

DP3F series

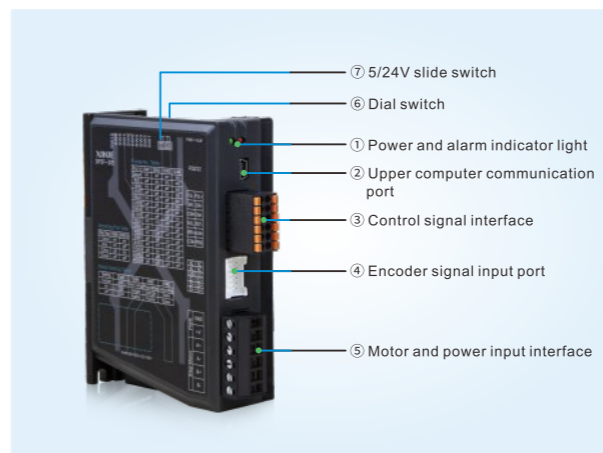

③ Control signal interface

Signal	Function
PUL+	Pulse control signal
PUL-	
DIR+	Direction control signal
DIR-	
ENA-	Enable input signal
RST-	Alarm clear input signal
COM+	Input signal common terminal
ALM+	Alarm output signal
PEND+/Z	In place/Z signal output
BRK+	Brake output signal
COM-	Output signal common terminal

④ Encoder signal input port

Signal	Function
NC	Reserved signal
NC	
NC	
VCC	5V power supply output, provided by the driver, only for encoder power supply
GND	
EZ+	Encoder Z phase signal +
EZ-	Encoder Z phase signal -
EB+	Encoder B phase signal +
EB-	Encoder B phase signal -
EA+	Encoder A phase signal +
EA-	Encoder A phase signal -

① Power and alarm indicator light

Color	Function
Green light	Power display PWR
Red light	Fault alarm indicator

Flashing message	Fault explanation
Flash once	Over current or short circuit
Flash continuously twice	Over voltage
Flash continuously 3 times	Under voltage
Flash continuously 4 times	Open circuit or poor contact of motor
Flash continuously 5 times	Position overlimit

*Note: When a fault occurs, the indicator light flashes continuously, pauses for one second and then flashes continuously.

⑤ Motor and power input interface

Interface	Function
A+, A-	Motor phase A
B+, B-	Motor phase B
GND	DC power supply ground
+V	DC power supply +

② Upper computer communication RS232 port

Signal	Explanation
TXD	RS232 send
RXD	RS232 receive
GND	RS232 ground

⑥ Dial switch

Dial switch	Function
SW1-SW4	Subdivision setting
SW5	Motor operation initial direction selection
SW6	Z/in place signal
SW7	Control signal pulse direction selection
SW8	Open/closed loop selection
SW9	Command smooth filter
SW10	

*Note: Please use the special cable provided by XINJE company for communication. RS232 default communication parameters: baud rate 115200bps, data bit 8, stop bit 1, even parity, station NO.1.

DP3L series



① Power and alarm indicator light

Color	Function	Flashing message	Fault explanation
Green light	Power display PWR	Flash once	Over current or short circuit
Red light	Fault alarm indicator		
		Flash continuously twice	Over voltage
		Flash continuously 4 times	Open circuit or poor contact of motor

*Note: When a fault occurs, the indicator light flashes continuously, pauses for one second and then flashes continuously.

② Control signal interface

Interface	Function
PUL+	Pulse signal input +
PUL-	Pulse signal input -
DIR+	Pulse direction input +
DIR-	Pulse direction input -
ENA+	Enable/release signal input +
ENA-	Enable/release signal input -
ERR	Driver error signal output
COM	Error signal ground

③ Dial switch

Dial switch	Function
SW1-SW3	Dynamic current setting
SW4	Half/full current setting
SW5-SW8	Subdivision accuracy setting

④ Power supply interface

Interface	Function
GND	DC power supply ground
+V	DC power supply +

⑤ Motor power cable interface

Interface	Function
A+, A-	Motor phase A
B+, B-	Motor phase B

Driver Peripheral Circuit

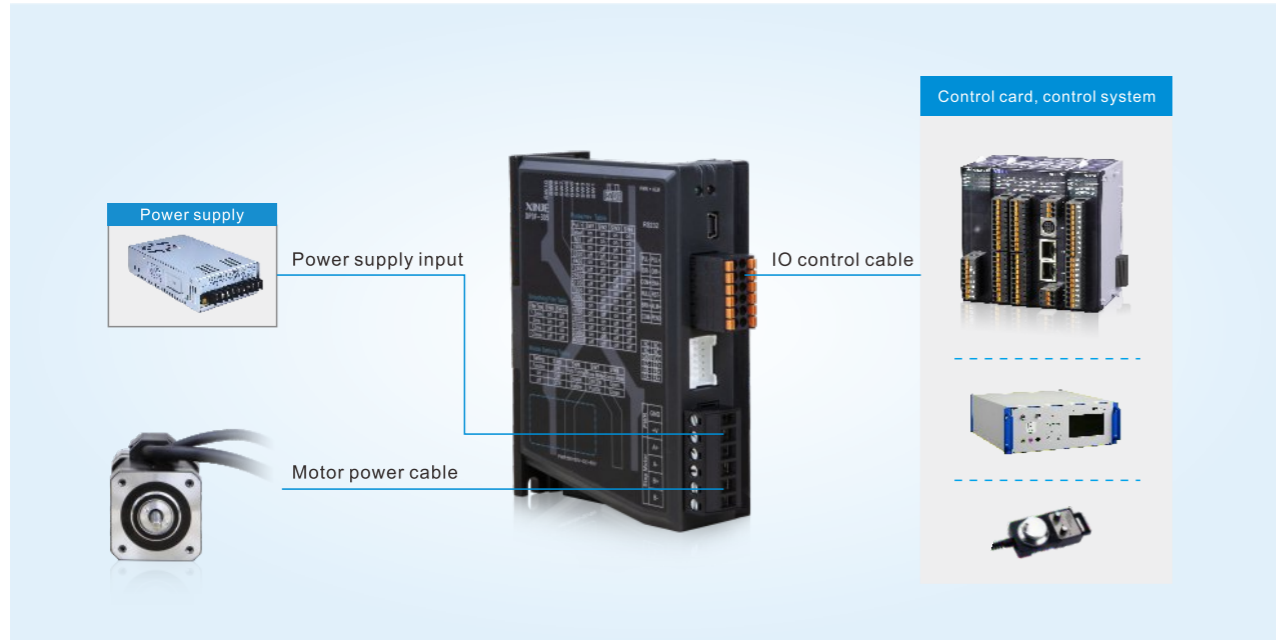

Driver Wiring Diagram

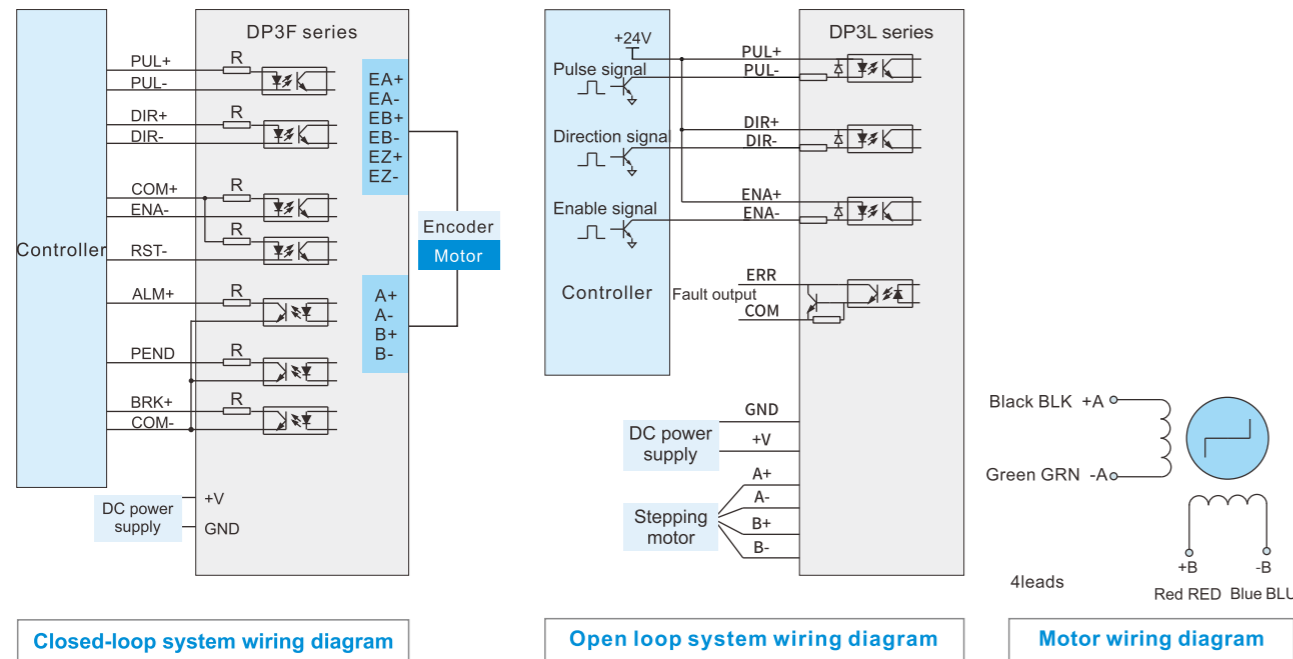

Product Model

Driver naming rule

DP3 L - 110 22 A 3

① ② ③ ④ ⑤ ⑥

① Name		② Series		③ Driver output peak current		④ Driver max power supply voltage	
Sign	Product name	Sign	Product series	Sign	Current	Sign	Voltage
DP3	Stepping driver	F	Closed-loop type	22	2.2A	4	40V
		L	Open loop type	30	3.0A	5	50V
				42	4.2A	8	80V
				56	5.6A	22	220V
				70	7.0A		
				80	8.0A		
				110	11.0A		

⑤ Voltage type		⑥ Driver type	
Sign	Power supply type	Sign	Driver type
A	AC/DC power supply	3	Three-phase driver
None	DC power supply	None	Two-phase driver

Driver Specification

		DP3F closed-loop pulse type			
Driver model		DP3F-305	DP3F-705	DP3F-808	DP3F-808A
Basic specification	Input power supply voltage (V)	DC 20~50	DC 20~50	DC 20~80	AC 20~80
	Output current peak value (A)	1~3	1~7	1~8.4	1~8.4
	Adaptive motor (base)	42	57/86	86	86
	Dimension (mm)	110*77*31	110*77*31	135*86.7*35.5	131*112.2*35
	Stepping pulse frequency (kHz)	24V signal 200K, 5V differential signal 500K			
	Control signal input voltage (VDC)	5/24 (slide switch setting)			
Use environment	Use occasion	Avoid dust, oil mist and corrosive gas			
	Ambient temperature	0°C~50°C			
	Maximum operating temperature	60°C			
	Humidity	40%~90% RH (no condensation or water droplets)			
	Vibration	5.9m/s ² Max			
	Storage temperature	-20°C~65°C			

		DP3L open loop pulse type					DP3L high voltage open loop pulse type	
Driver model		DP3L-224	DP3L-425	DP3L-565	DP3L-808	DP3L-808A	DP3L-11022A	DP3L-11022A3
Basic specification	Input power supply voltage (V)	DC 20~40	DC 20~50	DC 20~50	DC 20~80	AC 20~80	AC 200~240	AC 200~240
	Output current peak value (A)	0.5~2.2	1~4.2	1.8~5.6	2.7~8.4	2.7~8.4	3.1~11.3	3.1~11.3
	Adaptive motor (base)	42	57	57/86	86	86	110/130	86/110/130
	Dimension (mm)	92*62*28	110*77*31	110*77*31	135*86.7*35.5	131*112.2*35	199.5*137*79	199.5*137*79
	Stepping pulse frequency (kHz)	200 KHz					5/24V dial switch	
	Control signal input voltage (VDC)	24					5/24V dial switch	
Use environment	Use occasion	Avoid dust, oil mist and corrosive gas						
	Ambient temperature	0°C~50°C						
	Maximum operating temperature	60°C						
	Humidity	40%~90% RH (no condensation or water droplets)						
	Vibration	5.9m/s ² Max						
	Storage temperature	-20°C~65°C						

*Note: High voltage stepper is divided into two-phase and three-phase models, which are respectively suitable for two-phase and three-phase 110/130 stepper motors. Compared with two-phase stepping motor, three-phase stepping motor will run more smoothly, but under the condition of the same torque, two-phase motor has better cost performance.

Driver Dimension

(Unit: mm)

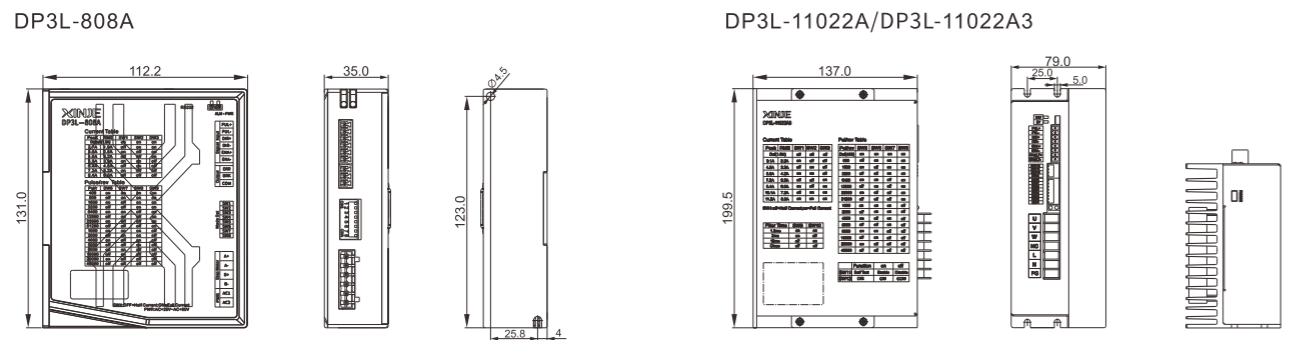
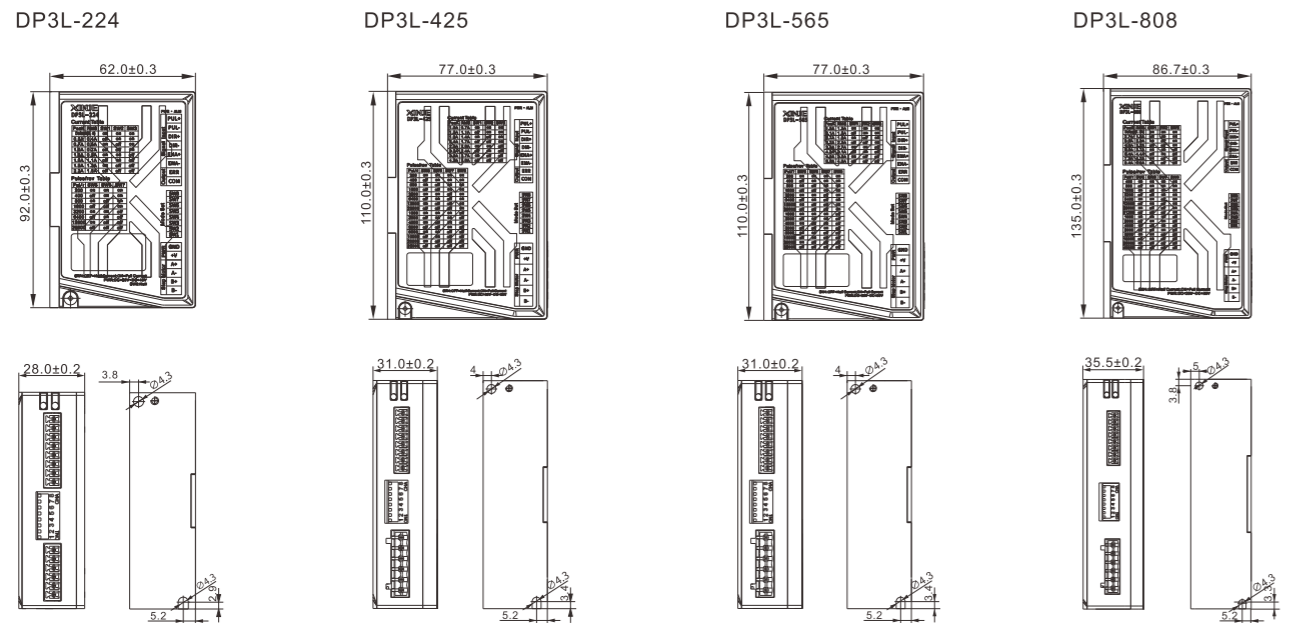
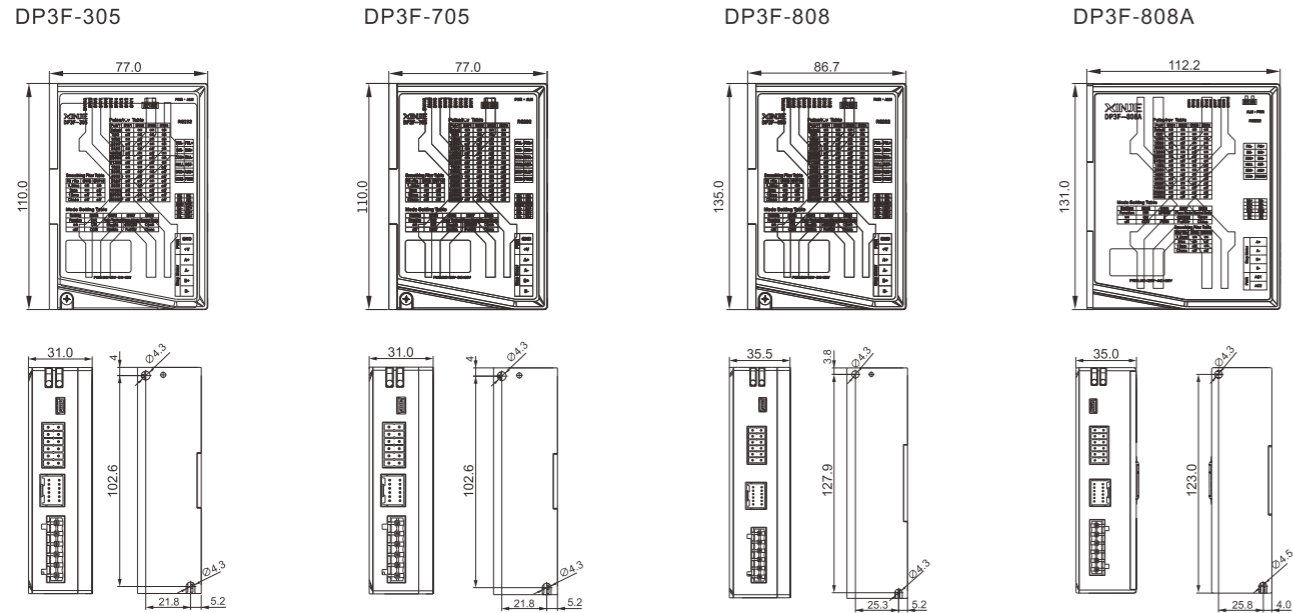

Accessories

*Note: Suitable for DP3F series

Encoder cable

Model	Length L (m)
CP-MD-2	2
CP-MD-3	3
CP-MD-5	5
CP-MD-8	8
CP-MD-10	10
CP-MD-12	12
CP-MD-16	16

CNA side	1	2	3	11	12	13
Color	Blue	Yellow	Yellow black	Green	Green black	Blue black
Definition	A+	VCC	GND	B+	B-	A-
CNB side	11	5	6	9	10	12

*Note: If Z signal output function is required, please use encoder cable [CP-MD-Z-length].

Power cable

Model	Length L (m)
CM-P07B-2	2
CM-P07B-3	3
CM-P07B-5	5
CM-P07B-8	8
CM-P07B-10	10
CM-P07B-12	12
CM-P07B-16	16

A end PIN	1	2	3	4
Definition	B+	A+	A-	B-

*Note: For customers who need make cable by themselves, they can buy accessory package JA-CM-P4, which includes the terminals suitable for the motor.

Stepping motor

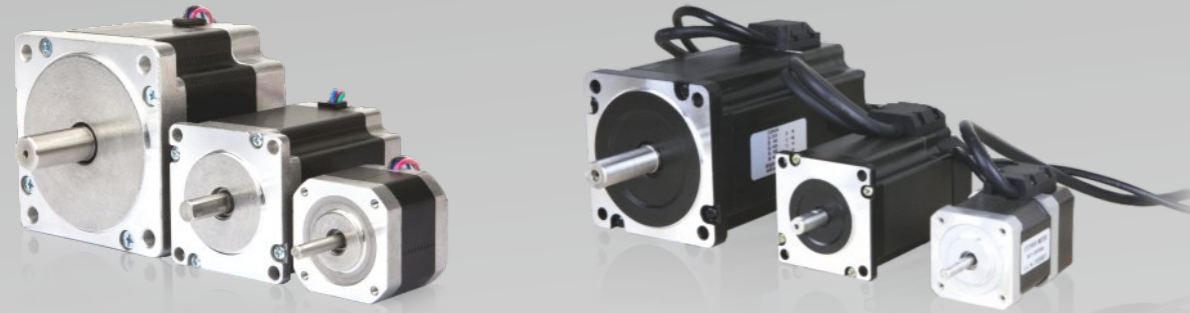

Motor naming rule

MP3- 57 H □ □ 076 - □

① ② ③ ④ ⑤ ⑥ ⑦

① Name		② Base number		③ Open closed loop type		④ Special motor type		⑤ Brake type		⑥ Body length		⑦ General customized code	
Sign	Product name	Sign	Base number	Sign	Type	Sign	Type	Sign	Power-off brake	Sign	Body length	Sign	Type
MP3	Stepping motor	42	42 base	H	Standard open loop motor	I	Waterproof motor	Vacant	Without brake	040	40mm	Vacant	Standard
		57	57 base	T	Optical encoder closed-loop motor	S	Double output shaft motor	Z	With brake	048	48mm	B	Right angle flat (without keyway) shaft
		60	60 base							056	56mm	D	Shaft diameter change
		86	86 base							060	60mm	L	Shaft length change
		110	110 base							065	65mm	Z	Z phase output closed-loop motor
		130	130 base							076	76mm		
										080	80mm		
										088	88mm		
										118	118mm		
										150	150mm		

*Note: The body length of the closed-loop motor needs to add the encoder length based on the open-loop motor. The encoder cable lengths include: 42 motor 18mm, 57 motor 20mm, 60 motor 22mm, 86 motor 26mm.

Adaptation table of closed-loop motor and driver

Closed-loop motor model		Base number (mm)	Step angle (°)	Holding torque (N.m)	Phase current (A)	Motor shaft	Motor shaft diameter(mm)	Adaptive driver
Standard series	Brake series							
MP3-42T048	/	42	1.8	0.5	1.68	Flat	5	DP3F/C-305
MP3-42T060	/		1.8	0.8	1.7	Flat	5	
MP3-57T056	/		1.8	1.3	4	Flat	8	
MP3-57T056-D6.35	/	57	1.8	1.3	4	Flat	6.35	DP3F/C-705
MP3-57T076	MP3-57TZ076		1.8	2.3	5	Flat	8	
MP3-57T088	MP3-57TZ088		1.8	3	5	Flat	8	
MP3-57T110	/		1.8	3	4	Flat	8	
MP3-60T088	MP3-60TZ088	60	1.8	3	5	Flat	8	DP3F/C-808
MP3-86T080	MP3-86TZ080		1.8	4.5	6	Flat key 5*25	14	
MP3-86T080-D12.7	/	86	1.8	4.5	6	Flat key 5*25	12.7	DP3F/C-808
MP3-86T098	MP3-86TZ098		1.8	8	6	Flat key 5*25	14	
MP3-86T118	MP3-86TZ118		1.8	8.5	6	Flat key 5*25	14	
MP3-86T118-D12.7	/		1.8	8.5	6	Flat key 5*25	12.7	
MP3-86T150	MP3-86TZ150		1.8	12	6	Flat key 5*25	14	

Adaptation table of three-phase open loop motor and driver

Three-phase open loop motor model		Base number (mm)	Step angle (°)	Holding torque (N.m)	Phase current (A)	Motor shaft	Motor shaft diameter(mm)	Adaptive driver
Standard series	Brake series							
MP3-110H3153	/	110	1.2	12	6	Flat key 6*30	19	DP3L-11022A3
MP3-110H3186	/		1.2	16	6.4	Flat key 6*30	19	
MP3-110H3221	/		1.2	20	6.9	Flat key 6*30	19	
MP3-130H3223	/	130	1.2	28	6.9	Flat key 8*36	24	DP3L-11022A3
MP3-130H3255	/		1.2	35	6.9	Flat key 8*36	24	
MP3-130H3319	/		1.2	50	6.9	Flat key 8*36	24	

Open loop motor model

Open loop motor model		Base number (mm)	Step angle (°)	Holding torque (N.m)	Phase current (A)	Motor shaft	Motor shaft diameter(mm)	Adaptive driver
Standard series	Brake series							
MP3-42H040	/	42	1.8	0.46	1.7	Flat	5	DP3CL-305 DP3L-224
MP3-42H048	/		1.8	0.5	1.68	Flat	5	
MP3-42H060	/		1.8	0.8	1.7	Flat	5	
MP3-57H044	/	57	1.8	0.6	3	Flat	8	DP3CL-705 DP3L-425/565
MP3-57H056	MP3-57HZ056		1.8	1.3	4	Flat	8	
MP3-57H056-D6.35	/		1.8	1.2	4	Flat	6.35	
MP3-57H076	MP3-57HZ076		1.8	2.3	5	Flat	8	
MP3-57H088	MP3-57HZ088		1.8	3	5	Flat	8	
MP3-57H110	/	60	1.8	3	4	Flat	8	DP3CL-808 DP3L-808
MP3-60H088	MP3-60HZ088		1.8	3	5	Flat	8	
MP3-86H065	MP3-86HZ065		1.8	3.5	4	Flat key 5*25	14	
MP3-86H065-D12.7	/	86	1.8	3.5	4	Flat key 5*25	12.7	DP3CL-808 DP3L-808
MP3-86H080	MP3-86HZ080		1.8	4.5	6	Flat key 5*25	14	
MP3-86H080-D12.7	/		1.8	4.5	6	Flat key 5*25	12.7	
MP3-86H098	MP3-86HZ098		1.8	8	6	Flat key 5*25	14	
MP3-86H098-D12.7	/		1.8	8	6	Flat key 5*25	12.7	
MP3-86H118	MP3-86HZ118		1.8	8.5	6	Flat key 5*25	14	
MP3-86H118-D12.7	/		1.8	8.5	6	Flat key 5*25	12.7	
MP3-86H150	MP3-86HZ150		1.8	12	6	Flat key 5*25	14	
MP3-110H150	/	110	1.8	20	6.5	Flat key 6*35	19	DP3L-11022A
MP3-110H201	/		1.8	28	6.5	Flat key 6*35	19	

Motor Mounting Dimension

(Unit: mm)

Closed-loop motor

42 series

Model	L(mm)	
	General	With brake
MP3-42T048	66	97
MP3-42T060	78	109

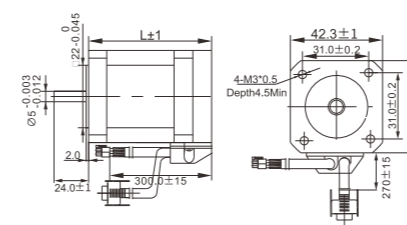

57 series

Model	L(mm)	
	General	With brake
MP3-57T056	76	116
MP3-57T076	96	136
MP3-57T110	130	150

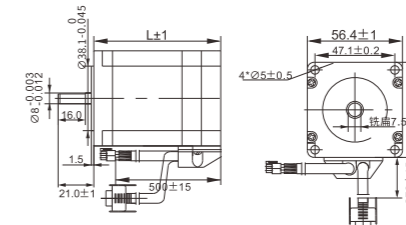

Large 57 series

Model	L(mm)	
	General	With brake
MP3-57T088	110	150

*Note: This motor adopts the body width of 60 motor and the front cover of 57 motor. The installation method is the same as that of 57 motor. With a relatively short body length, the holding torque of 3N can be achieved, which improves the stability of the motor.

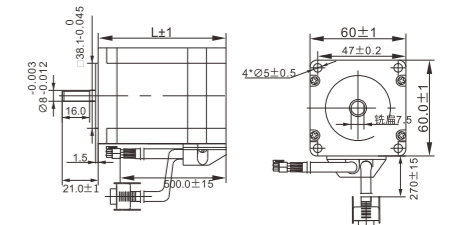

60 series

Model	L(mm)	
	General	With brake
MP3-60T088	110	150

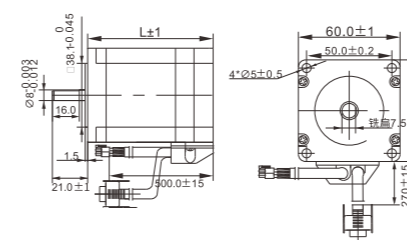

86 series

Model	L(mm)	
	General	With brake
MP3-86T080	106	149
MP3-86T098	122	155
MP3-86T118	144	187
MP3-86T150	174	217

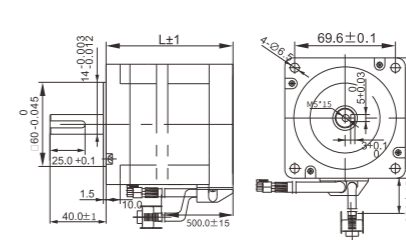

Motor Mounting Dimension

(Unit: mm)

Two-phase open loop motor

42 series

Model	L(mm)	
	General	With brake
MP3-42H040	39.5	70
MP3-42H048	48	79
MP3-42H060	60	91

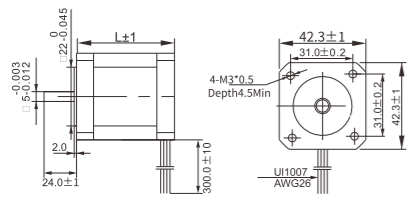

57 series

Model	L(mm)	
	General	With brake
MP3-57H056	56	96
MP3-57H076	76	116
MP3-57H110	110	150

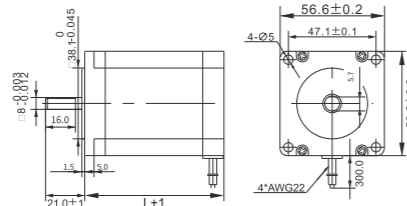

Large 57 series

Model	L(mm)	
	General	With brake
MP3-57H088	88	128

*Note: This motor adopts the body width of 60 motor and the front cover of 57 motor. The installation method is the same as that of 57 motor. With a relatively short body length, the holding torque of 3N can be achieved, which improves the stability of the motor.

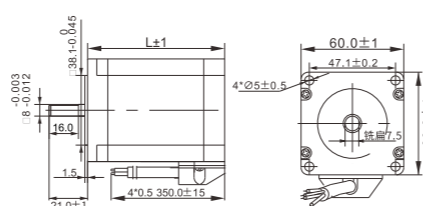

60 series

Model	L(mm)	
	General	With brake
MP3-60H088	88	128

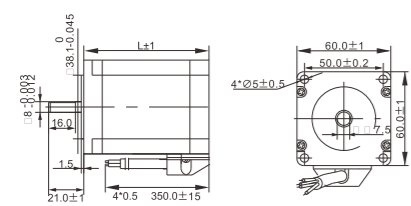

86 series

Model	L(mm)	
	General	With brake
MP3-86H065	65	108
MP3-86H080	80	123
MP3-86H098	98	141
MP3-86H118	118	161
MP3-86H150	150	193

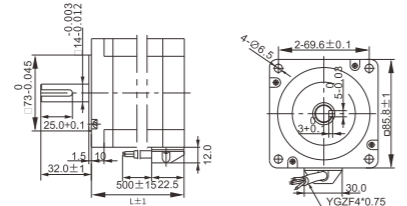

110 series

Model	L(mm)	
	General	With brake
MP3-110H150	150	/
MP3-110H201	201	/

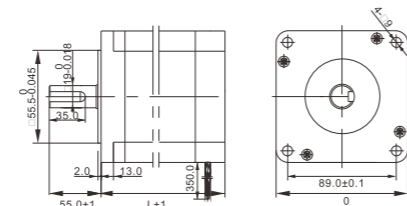

Three-phase open loop motor

110 series

Model	L(mm)	
	General	With brake
MP3-110H3153	151	/
MP3-110H3186	185	/
MP3-110H3221	219	/

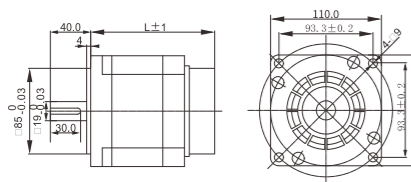

130 series

Model	L(mm)	
	General	With brake
MP3-130H3223	222	/
MP3-130H3255	254	/
MP3-130H3319	319	/

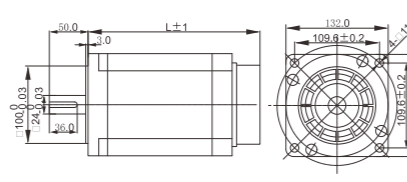

Motor Torque Frequency Characteristic Diagram

Closed-loop series (the follow current is peak current)

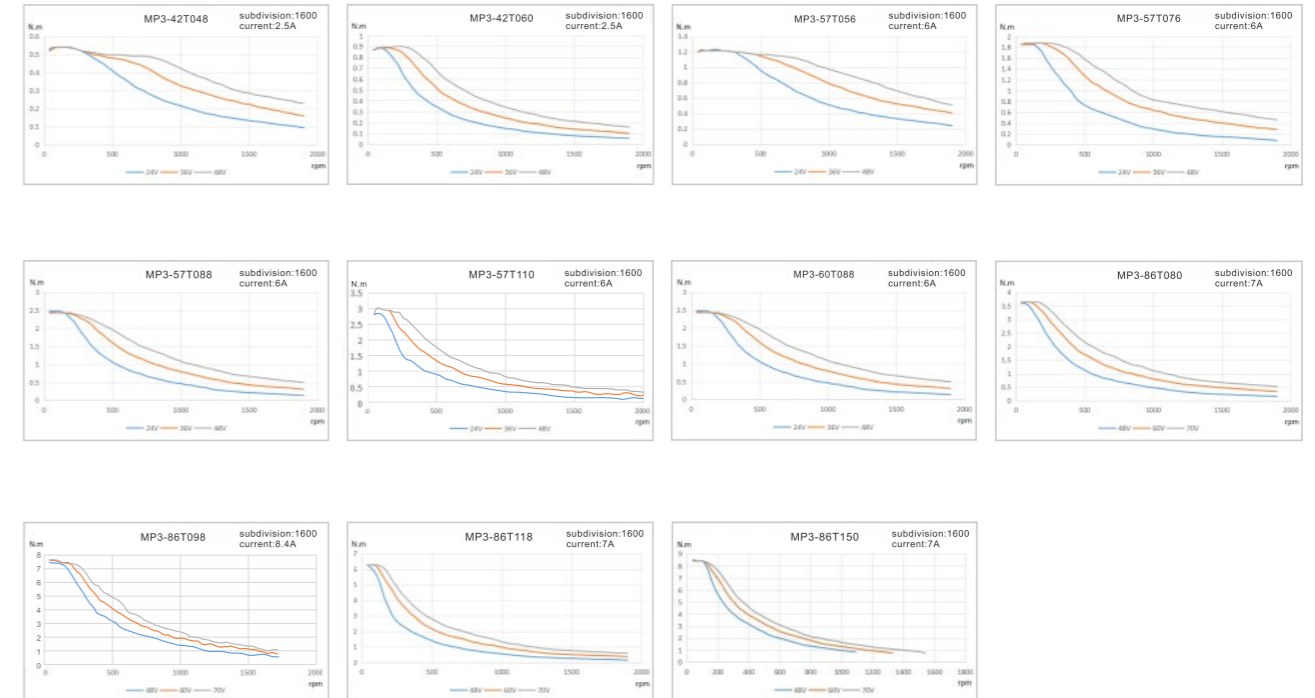

Two-phase open loop series (the follow current is peak current)

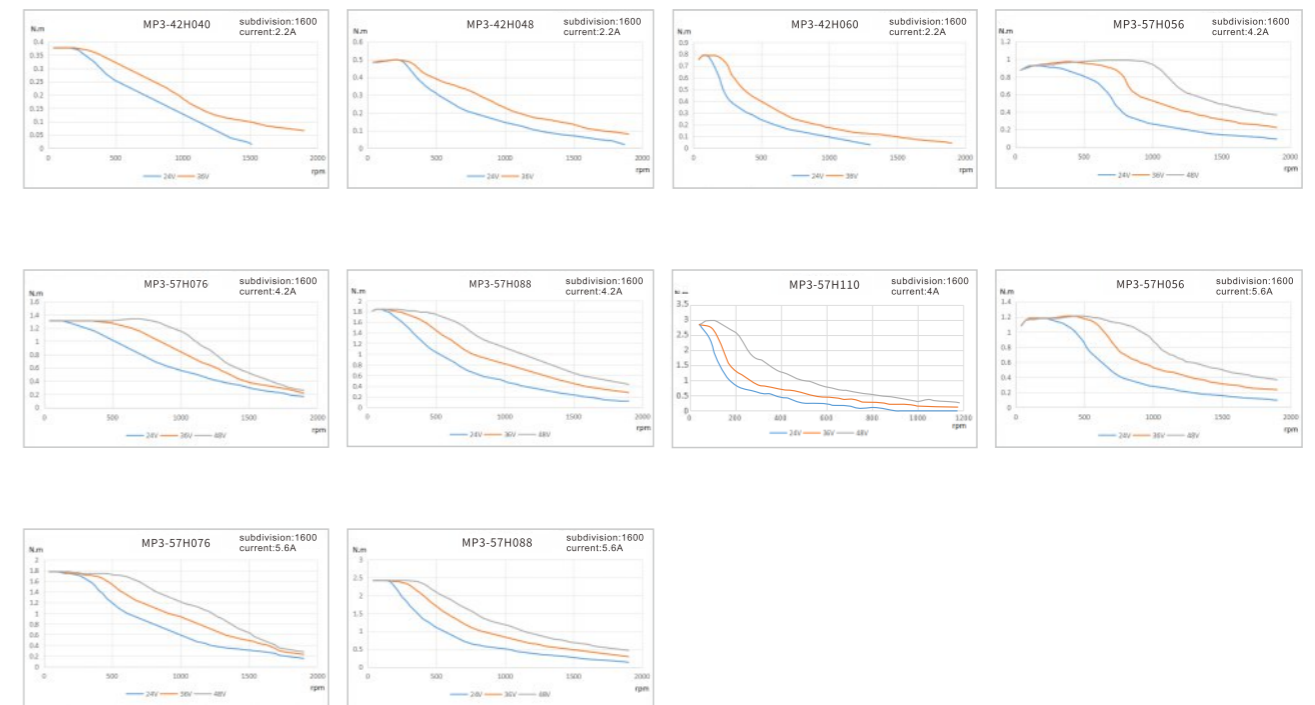

Motor Torque Frequency Characteristic Diagram

Two-phase open loop series (the follow current is peak current)

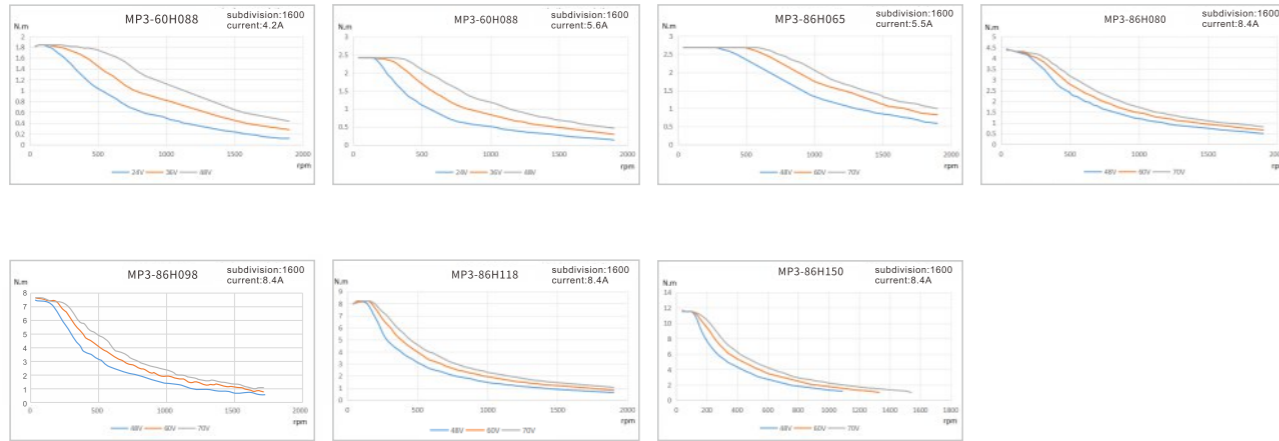

Three-phase open loop series (the follow current is peak current)

